

User Manual UR3e

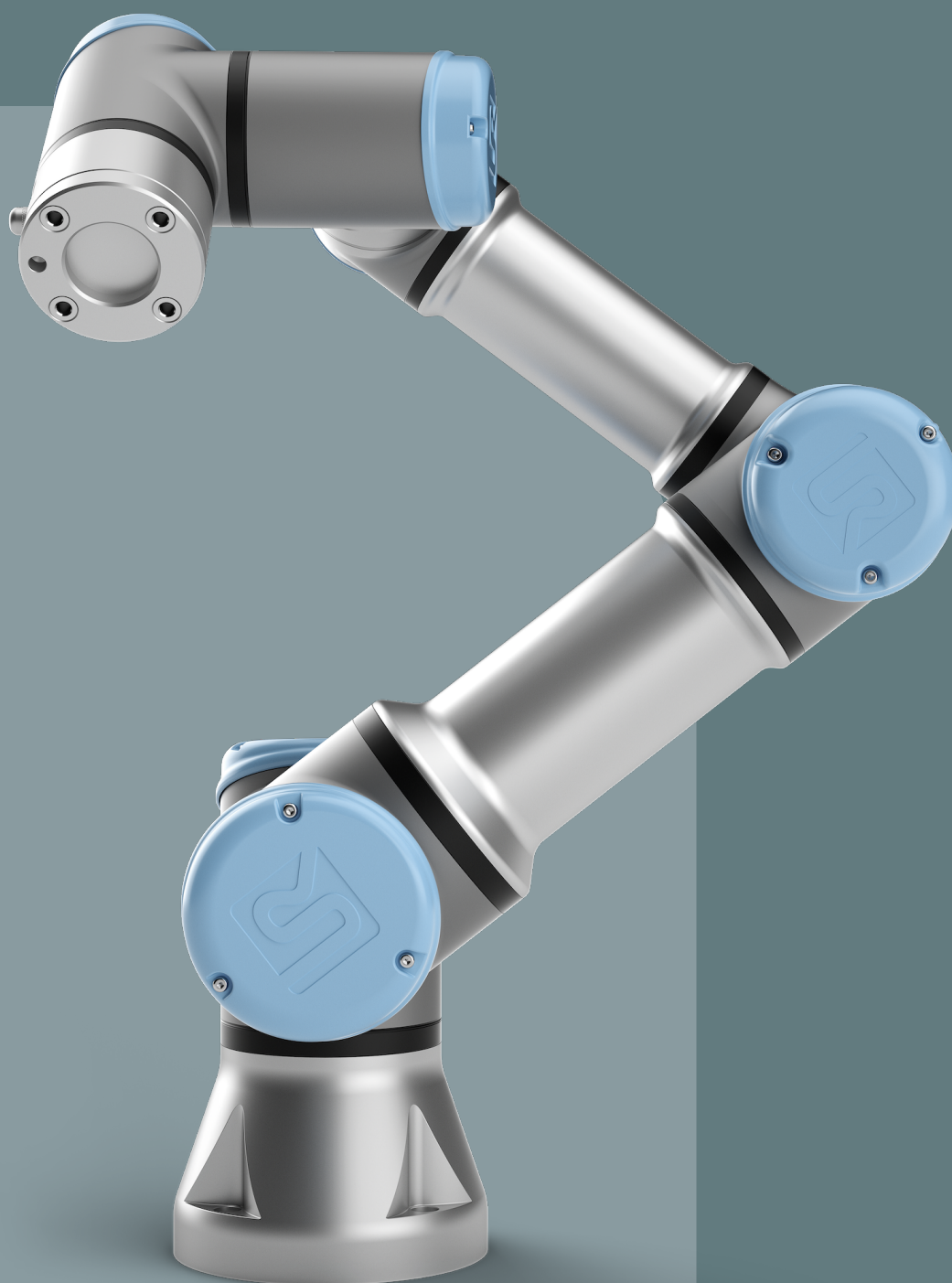







The information contained herein is the property of Universal Robots A/S and shall not be reproduced in whole or in part without prior written approval of Universal Robots A/S. The information herein is subject to change without notice and should not be construed as a commitment by Universal Robots A/S. This document is periodically reviewed and revised.

Universal Robots A/S assumes no responsibility for any errors or omissions in this document.

Copyright © 2009-2024 by Universal Robots A/S.

The Universal Robots logo is a registered trademark of Universal Robots A/S.



Contents

1. Preface	12
Part I Hardware Installation Manual	15
2. Safety	16
2.1. Validity and Responsibility	17
2.2. Limitation of Liability	17
2.3. Safety Message Types	18
2.4. General Warnings and Cautions	19
2.5. Intended Use	21
2.6. Risk Assessment	23
2.7. Pre-Use Assessment	25
2.8. Emergency Stop	26
2.9. Movement Without Drive Power	27
2.10. Safety-related Functions and Interfaces	28
2.10.1. Stop Categories	29
2.10.2. Configurable Safety Functions	30
2.10.3. Safety Functions	34
2.10.4. Safety Parameter Set	35
2.10.5. Modes	37
3. Mechanical Interface	38
3.1. Workspace and Operating Space	38
3.2. Mounting Description	39
3.3. Securing the Robot Arm	40
3.4. Securing Tool	41
3.5. Control Box Clearance	42
3.6. Maximum Payload	43
4. Electrical Interface	44
4.1. Electrical Warnings and Cautions	44
4.2. Controller I/O	46
4.3. Safety I/O	48
4.4. Three Position Enabling Device	52
4.5. General Purpose Digital I/O	54
4.6. General Purpose Analog I/O	55
4.7. Remote ON/OFF Control	56
4.8. Control Box Bracket	58
4.9. Ethernet	58
4.10. Mains Connections	59



- 4.11. Robot Connections: Robot Cable 61
- 4.12. Robot Connections: Base Flange Cable 62
- 4.13. Tool I/O 63
- 4.14. Tool Power Supply 65
- 4.15. Tool Digital Outputs 66
- 4.16. Tool Digital Inputs 67
- 4.17. Tool Analogue Inputs 67
- 4.18. Tool Communication I/O 68
- 5. Transportation 69**
 - 5.1. Transport Without Packaging 70
- 6. Maintenance and Repair 71**
 - 6.1. Cleaning 72
 - 6.2. Inspection 72
 - 6.2.1. Robot Arm Inspection Plan 72
 - 6.2.2. Robot Arm Visual Inspection 73
 - 6.2.3. Freedrive Inspection 74
 - 6.2.4. Control Box Inspection Plan 75
- 7. Disposal and Environment 76**
- 8. Certifications 77**
- 9. Stopping Time and Stopping Distance 79**
- 10. Declarations and Certificates (original EN) 83**
- 11. Warranty Information 85**
- 12. Certificates 86**
- 13. Applied Standards 91**
- 14. Technical Specifications 95**
- 15. Safety Functions Table 1 96**
 - 15.1. Table 1a 104
 - 15.2. Table 2 105
- Part II PolyScope Manual 109**
- 16. Introduction 111**
 - 16.1. Robot Arm Basics 111
 - 16.2. Robot Arm Installation 112
 - 16.3. PolyScope Overview 116
 - 16.3.1. Icons/Tabs On PolyScope 117
 - 16.4. Freedrive 119
 - 16.4.1. Freedrive Panel 121
 - 16.5. Backdrive 122
 - 16.5.1. Backdrive Inspection 124

16.6. Quick System Start-up	126
16.7. The First Program	127
16.8. Robot Cyber Security	129
16.9. Operational Mode Selection	130
17. Software Safety Configuration	133
17.1. Setting a Software Safety Password	135
17.2. Changing the Software Safety Configuration	136
17.3. Applying a New Software Safety Configuration	137
17.3.1. Safety Checksum	137
17.4. Safety Configuration without Teach Pendant	139
17.5. Software Safety Modes	139
17.6. Software Safety Limits	140
17.6.1. Robot Limits	140
17.6.2. Joint Limits	142
17.7. Safety I/O	145
17.8. Software Safety Restrictions	149
17.8.1. Tool Direction Restriction	157
17.8.2. Tool Position Restriction	159
17.9. Safe Home Position	163
18. Run Tab	165
18.1. Move Robot into Position	168
18.2. Program	169
18.3. Variables	169
19. Program Tab	171
19.1. Robot Program Configuration	173
19.2. Program Tree Toolbar	175
19.2.1. Variable Setup	175
19.2.2. Command Tab	178
19.2.3. Graphics Tab	181
19.2.4. Variables Tab	183
19.3. Expression Editor	184
19.4. Starting a Program from a Selected Program Node	185
19.5. Using Breakpoints in a Program	186
19.6. Single Step in a Program	189
19.7. Basic program nodes	191
19.7.1. Move	191
19.7.2. Waypoints	195
19.7.3. Direction	218
19.7.4. Wait	220



- 19.7.5. Set 225
- 19.7.6. Popup 227
- 19.7.7. Halt 230
- 19.7.8. Comment 231
- 19.7.9. Folder 232
- 19.7.10. Set Payload 233
- 19.8. Advanced program nodes 234
 - 19.8.1. Loop 234
 - 19.8.2. SubProgram 235
 - 19.8.3. Assignment 237
 - 19.8.4. If 237
 - 19.8.5. Script 239
 - 19.8.6. Event 240
 - 19.8.7. Thread 240
 - 19.8.8. Switch 241
 - 19.8.9. Timer 243
 - 19.8.10. Home 243
- 19.9. Templates 246
 - 19.9.1. Seek 246
 - 19.9.2. Force 250
 - 19.9.3. Palletizing 254
 - 19.9.4. Conveyor Tracking 260
 - 19.9.5. Screwdriving 262
- 19.10. URCaps 265
- 20. Installation Tab 274**
 - 20.1. TCP Configuration 274
 - 20.1.1. Teaching TCP Position 276
 - 20.2. Payload 277
 - 20.3. Mounting 280
 - 20.4. I/O Setup 281
 - 20.5. Installation Variables 284
 - 20.6. Startup 287
 - 20.7. Tool I/O 288
 - 20.7.1. Analog Input - Communication Interface 288
 - 20.7.2. Digital Output Mode 289
 - 20.8. Smooth Transition 289
 - 20.9. Home 290
 - 20.10. Conveyor Tracking Setup 291
 - 20.11. Screwdriving Setup 292
 - 20.12. Safety 295

20.13. Features	295
20.13.1. Feature Edit	303
20.14. Fieldbus	304
20.14.1. MODBUS Client I/O Setup	304
20.14.2. EtherNet/IP	307
20.14.3. PROFINET	308
20.14.4. PROFIsafe	308
21. Move Tab	314
21.1. Pose Editor Screen	318
22. I/O Tab	320
22.1. MODBUS	322
23. Log Tab	323
24. Program and Installation Manager	326
24.1. File Manager	330
25. Hamburger menu	331
25.1. About	331
25.1.1. Help	332
25.2. Settings	334
25.2.1. Preferences	334
25.2.2. Password	335
25.2.3. System	337
25.2.4. Security	344
25.3. Shutdown Robot	349
26. Glossary	350
26.1. Index	351

1. Preface

Introduction

Congratulations on the purchase of your new Universal Robots e-Series robot. The robot can be programmed to move a tool, and communicate with other machines using electrical signals. It is an arm composed of extruded aluminium tubes and joints. Using our patented programming interface, PolyScope, it is easy to program the robot to move the tool along a desired trajectory.

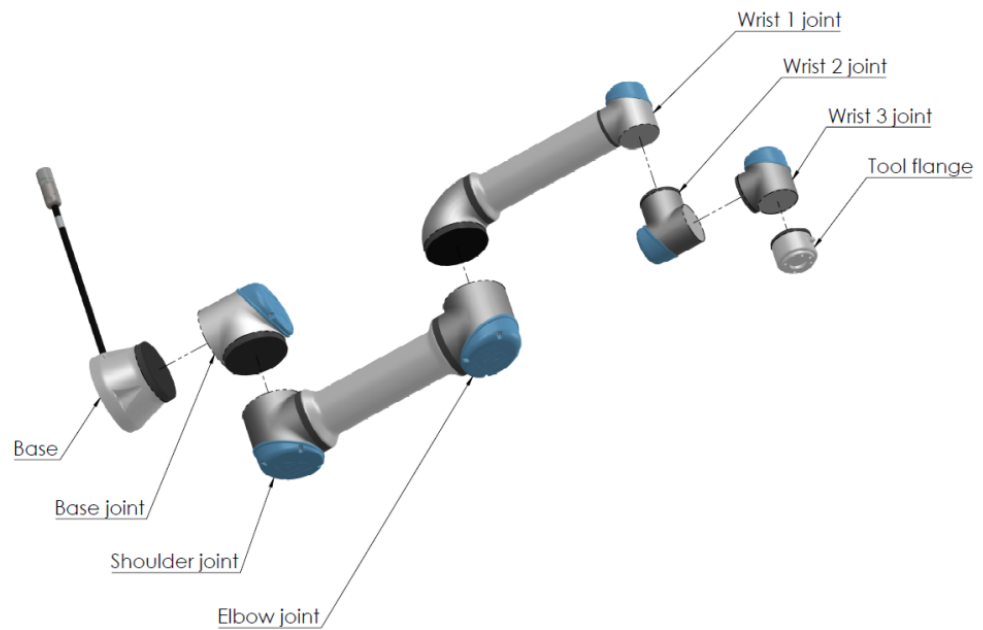

1.1: The joints, the base and the tool flange of the Robot Arm.

With six joints and a wide scope of flexibility, Universal Robots e-Series collaborative robot arms are designed to mimic the range of motion of a human arm. Using our patented programming interface, PolyScope, it is easy to program the robot to move tools and communicate with other machines using electrical signals. Figure 1.1 The joints, the base and the tool flange of the Robot Arm. above illustrates the main components of the robot arm and can be used as a reference throughout the manual.

What Do the Boxes Contain When you order a robot, you receive two boxes. One contains the Robot Arm, the other contains:

- Control Box with Teach Pendant
- Mounting bracket for the Control Box
- Mounting bracket for the Teach Pendant
- Key for opening the Control Box
- Cable for connecting the robot arm and the Control Box (see options in [14 Technical Specifications on page 95](#))
- Mains cable or Power cable compatible to your regions
- This manual

Important Safety Notice The robot is **partly completed machinery** (see [Declarations According to EU directives on page 78](#)) and as such a risk assessment is required for each installation of the robot. You must follow all of the safety instructions in chapter [2 Safety on page 16](#).

How to Read This Manual This manual contains instructions for installing and programming the robot. The manual is separated into two parts:

Hardware Installation Manual
The mechanical and electrical installation of the robot.

PolyScope Manual
Programming of the robot.

This manual is intended for the robot integrator who must have a basic level of mechanical and electrical training, as well as be familiar with elementary programming concepts.

Where to Find More Information The support website (www.universal-robots.com/support) contains the following:

- Other language versions of this manual
- **PolyScope Manual**
- The **Service Manual** with instructions for troubleshooting, maintenance and repair
- The **Script Manual** for advanced users

UR+ The UR+ site (www.universal-robots.com/plus) is an online showroom that provides cutting-edge products to customize your UR robot application. You can find everything you need in one place—from end-effectors and accessories to vision cameras and software. All products are tested and approved to integrate with UR robots, ensuring simple set-up, reliable operation, smooth user experience, and easy programming. You can also access the UR+ Partner Program via our new software platform (plus.universal-robots.com), allowing you to design more user-friendly products for UR robots.

**myUR**

myUR is a customer portal that allows you to register all your robots, keep track of service cases on robots and general support questions. Go to myur.universal-robots.com and sign up to gain access to the portal. Cases are handled either by your preferred distributor or escalated to Universal Robots Customer Service teams. On top of these features, it is also possible to subscribe to robot monitoring and manage additional user accounts in your company.

UR Forums

The UR Forums site (forum.universal-robots.com) allows robot enthusiasts of all skill levels to connect to UR and each other, to ask questions, and to exchange information etc. While the UR Forum was created by UR+ and our admins are UR employees, the vast majority of the content is created by you, the UR Forum user.

Part I

Hardware Installation Manual

2. Safety

Description

This chapter contains important safety information, which must be read and understood by the integrator of Universal Robots e-Series robots **before** the robot is powered on for the first time.

In this chapter, the first subsections are general. The later subsections contain specific engineering data relevant to enable setting up and programming the robot.

Chapter [2.10 Safety-related Functions and Interfaces on page 28](#) describes and defines safety-related functions particularly relevant for collaborative applications.

Instructions and guidance provided in chapter [2.10 Safety-related Functions and Interfaces on page 28](#) as well as in section [2 Safety above](#) are particularly important.

It is essential to observe and follow all assembly instructions and guidance provided in other chapters and parts of this manual.

Special attention shall be paid to text associated with warning symbols.



NOTICE

Universal Robots disclaims any and all liability if the robot (arm control box and/or teach pendant) is damaged, changed or modified in any way. Universal Robots cannot be held responsible for any damages caused to the robot or any other equipment due to programming errors or malfunctioning of the robot.

2.1. Validity and Responsibility

Description

The information in this manual does not cover designing, installing and operating a complete robot application, nor does it cover all peripheral equipment that can influence the safety of the complete system. The complete system must be designed and installed in accordance with the safety requirements set forth in the standards and regulations of the country where the robot is installed.

The integrators of Universal Robots e-Series robots are responsible for ensuring that the applicable safety laws and regulations in the country concerned are observed and that any significant hazards in the complete robot application are eliminated. This includes, but is not limited to:

- Performing a risk assessment for the complete robot system
 - Interfacing other machines and additional safety devices if defined by the risk assessment
 - Setting up the appropriate safety settings in the software
 - Ensuring that the user will not modify any safety measures
 - Validating that the total robot system is designed and installed correctly
 - Specifying instructions for use
 - Marking the robot installation with relevant signs and contact information of the integrator
 - Collecting all documentation in a technical file; including the risk assessment and this manual
-

2.2. Limitation of Liability

Description

Any safety information provided in this manual must not be construed as a warranty, by UR, that the industrial manipulator will not cause injury or damage, even if industrial manipulator complies with all safety instructions.

2.3. Safety Message Types

Description

Safety messages are used to emphasize important information. Read all the messages to help ensure safety and to prevent injury to personnel and product damage. The safety message types are defined below.



WARNING

Indicates a hazardous situation that, if not avoided, can result in death or serious injury.



WARNING: ELECTRICITY

Indicates a hazardous electrical situation that, if not avoided, can result in death or serious injury.



WARNING: HOT SURFACE

Indicates a hazardous hot surface where injury can result from contact and non-contact proximity.



CAUTION

Indicates a hazardous situation that, if not avoided, can result in injury.



GROUND

Indicates grounding.



PROTECTIVE GROUND

Indicates protective grounding.



NOTICE

Indicates the risk of damage to equipment and/or information to be noted.



READ MANUAL

Indicates more detailed information that should be consulted in the manual.

2.4. General Warnings and Cautions

Description

The following warnings, cautions and messages can be repeated, explained or detailed in different parts of this manual.



WARNING

Failure to adhere to the general safety practices, listed below, can result in injury.

- Verify the robot arm and tool/end effector are properly and securely bolted in place.
- Verify the robot arm has ample space to operate freely.
- Verify the personnel are protected during installation, commissioning, programming/ teaching, operation and use.
- Verify robot safety configuration parameters are set to protect personnel, including those who can be within reach of the robot application.
- Avoid using the robot if it is damaged.
- Avoid wearing loose clothing or jewelry when working with the robot. Tie back long hair.
- Avoid placing any fingers behind the internal cover of the Control Box.
- Inform users of any hazardous situations and the protection that is provided, explain any limitations of the protection and the residual risks.
- Inform users of the location of the emergency stop button(s) and how to activate the emergency stop in case of an emergency or an abnormal situation.
- Warn people to keep their heads and faces outside the reach of the robot, including when the robot is about to start operating.
- Be aware of robot orientation to understand the direction of movement when using the Teach Pendant.



WARNING

Handling tools/end effectors with sharp edges and/or pinch points can result in injury.

- Make sure tools/end effectors have no sharp edges or pinch points.
- Protective gloves and/or protective eyeglasses could be required.



WARNING: HOT SURFACE

Prolonged contact with the heat generated by the robot arm and the Control Box, during operation, can lead to discomfort resulting in injury.

- Do not handle or touch the robot while in operation or immediately after operation.
- Check the temperature on the log screen before handling or touching the robot.
- Allow the robot to cool down by powering it off and waiting one hour.



CAUTION

Failure to perform a risk assessment prior to operation can increase risk of injury.

- Perform a risk assessment and reduce risks prior to operation.
- If determined by the risk assessment, do not enter the range of the robot movement or touch the robot during operation.
- Read the information found in Risk Management.



CAUTION

Using the robot with untested external machinery, or in an untested system, can increase the risk of injury to personnel.

- Test all functions and the robot program separately.



NOTICE

Very strong magnetic fields can damage the robot.

- Do not expose the robot to permanent magnetic fields.



READ MANUAL

Verify all mechanical and electrical equipment is installed according to the specifications and warnings found in the [Mechanical Interface](#) and in the [4 Electrical Interface on page 44](#).

2.5. Intended Use

Description



READ MANUAL

Failure to use the robot arm in accordance with the intended use can result in hazardous situations.

- Read and follow the recommendations for intended use and the specifications provided in the User Manual.

Universal Robots robots are intended for industrial use, to handle tools/end effectors and fixtures, or to process or transfer components or products. For details about the conditions under which the robot should operate, see Declarations and Certificates and the technical specifications.

All Universal Robots robots are equipped with safety functions, which are purposely designed to enable collaborative applications, where the robot application operates together with a human.

Collaborative applications are only intended for non-hazardous applications, where the complete application, including tool/end effector, work piece, obstacles and other machines, is without any significant hazards according to the risk assessment of the specific application.



WARNING

Using the robot arm outside of the intended purposes can result in injuries.

- Do not use the robot for any of the below:
 - Any use in hazardous locations or explosive environments.
 - Medical applications with contact or proximity to patients.
 - Any application requiring compliance with specific hygienic and/or sanitation standards, such as direct contact with food, beverage and/or pharmaceutical products.
 - Any use or application deviating from the intended use, specifications, and certifications is prohibited as the result could be death, personal injury and/or property damage.

UNIVERSAL ROBOTS EXPRESSLY DISCLAIMS ANY EXPRESS OR IMPLIED WARRANTY OF FITNESS FOR ANY MISUSE.

WARNING

Using the robot arm outside of the intended purposes can result in injuries.

- Do not use the robot for any of the below:
 - Any use in hazardous locations or explosive environments.
 - Medical applications with contact or proximity to patients.
 - Any application requiring compliance with specific hygienic and/or sanitation standards, such as direct contact with food, beverage and/or pharmaceutical products.
 - Any use or application deviating from the intended use, specifications, and certifications is prohibited as the result could be death, personal injury and/or property damage.

UNIVERSAL ROBOTS EXPRESSLY DISCLAIMS ANY EXPRESS OR IMPLIED WARRANTY OF FITNESS FOR ANY MISUSE.

WARNING

Avoid modifying the robot. A modification might create unforeseen hazards. All authorized reassembling shall be done according to the newest version of all relevant service manuals.

WARNING

Failure to consider the added risks of a longer reach, higher payloads and greater operating torques and speeds associated with a bigger robot, can result in injury or death.

- Your risk assessment shall include the additional reach, payload and speed risks.

2.6. Risk Assessment

Description

The risk assessment is a legal requirement, that shall be performed by a 3rd party integrator, or by the user of the UR robot in the role of integrator.

The robot itself is partly completed machinery, as the safety of the robot installation depends on how the robot is integrated (E.g. tool/end effector, obstacles and other machines). It is recommended that the party performing the integration use ISO 12100 and ISO 10218-2 to conduct the risk assessment. Integration can apply Technical Specification ISO/TS 15066 as additional guidance. The risk assessment shall consider all work tasks throughout the lifetime of the robot application, including but not limited to:

- Teaching the robot during set-up and development of the robot installation
- Troubleshooting and maintenance
- Normal operation of the robot installation

A risk assessment must be conducted **before** the robot arm is powered on for the first time. A part of the risk assessment conducted by the integrator is to identify the proper safety configuration settings, as well as the need for additional emergency stop buttons and/or other protective measures required for the specific robot application.

Risk @ Robot

Identifying the correct safety configuration settings is a particularly important part of developing collaborative robot applications. See chapter and part for detailed information.

Some safety functions are purposely designed for collaborative robot applications. These features are configurable through the safety configuration settings and are particularly relevant when addressing specific risks in the risk assessment conducted by the integrator:

- **Force and power limiting:** Used to reduce clamping forces and pressures exerted by the robot in the direction of movement in case of collisions between the robot and the operator.
- **Momentum limiting:** Used to reduce high transient energy and impact forces in case of collisions between robot and operator by reducing the speed of the robot.
- **Joint, elbow and tool/end effector position limiting:** Particularly used to reduce risks associated with certain body parts. E.g. to avoid movement towards head and neck.
- **Tool/end effector orientation limiting:** Particularly used to reduce risks associated with certain areas and features of the tool/end effector and work-piece. E.g. to avoid sharp edges to be pointed towards the operator.
- **Speed limitation:** Particularly used to ensure a low speed of the robot arm.

Warning

Unauthorized access to the safety configuration must be prevented by enabling and setting password protection during the integration.



WARNING

Failure to conduct a collaborative application risk assessment can increase hazards.

- Always conduct a collaborative application risk assessment for intentional collisions and/or collisions due to reasonably foreseeable misuse.
- The collaborative application shall address:
 - Severity of individual potential collisions.
 - Likelihood of occurrence of individual potential collisions.
 - Possibility to avoid individual potential collisions.

If the robot is installed in a non-collaborative robot application where hazards cannot be reasonably eliminated or risks cannot be sufficiently reduced by use of the built-in safety-related functions (e.g. when using a hazardous tool/end effector), then the risk assessment conducted by the integrator must conclude the need for additional protective measures (e.g. an enabling device to protect the operator during set-up and programming).

Potential Hazards

Universal Robots identifies the potential significant hazards listed below as hazards that must be considered by the integrator. Other significant hazards can be present in a specific robot installation.

1. Penetration of skin by sharp edges and sharp points on tool/end effector or tool/end effector connector.
2. Penetration of skin by sharp edges and sharp points on obstacles near the robot track.
3. Bruising due to contact with the robot.
4. Sprain or bone fracture due to strokes between a heavy payload and a hard surface.
5. Consequences due to loose bolts that hold the robot arm or tool/end effector.
6. Items falling out of tool/end effector, e.g. due to a poor grip or power interruption.
7. Mistakes due to different emergency stop buttons for different machines.
8. Mistakes due to unauthorized changes to the safety configuration parameters.

Information on stopping times and stopping distances are found in chapter and appendix .

2.7. Pre-Use Assessment

Description

The following tests must be conducted before using the robot for the first time or after any modifications are made. Verify that all safety input and output are appropriately and correctly connected. Test that all connected safety input and output, including devices common to multiple machines or robots, are functioning. As such you must:

- Test that emergency stop buttons and input stop the robot and engage brakes.
 - Test that safeguard input stop the robot motion. If safeguard reset is configured, check that it needs to be activated before motion can be resumed.
 - Examine the initialization screen to test that reduced mode can switch the safety mode to reduced mode.
 - Test that the operational mode switches the operational mode, see icon in top right corner of user interface.
 - Test that the 3-position enabling device must be pressed to enable motion in manual mode and that the robot is under reduced speed control.
 - Test that System Emergency Stop outputs are actually capable of bringing the whole system to a safe state.
 - Test that the system connected to Robot Moving output, Robot Not Stopping output, Reduced Mode output, or Not Reduced Mode output can actually detect the output changes
-

2.8. Emergency Stop

Description

The Emergency Stop or E-stop is the red push-button located on the Teach Pendant. Press the emergency stop push-button to stop all robot motion. Activating the emergency stop push-button causes a stop category one (IEC 60204-1). Emergency stops are not safeguards (ISO 12100). Emergency stops are complementary protective measures that are not intended to prevent injury. The risk assessment of the robot application determines if additional emergency stop push-buttons are required. The emergency stop function and the actuating device must comply with ISO 13850.

After an emergency stop is activated, the push-button latches in that setting. As such, each time an emergency stop is activated, it must be manually reset at the push-button that initiated the stop.

Before resetting the emergency stop push-button, you must visually identify and assess the reason the E-stop was first activated. Visual assessment of all the equipment in the application is required. Once the problem is solved, reset the emergency stop push-button.

To reset the emergency stop push-button

1. Hold the push-button and twist clockwise until the latching disengages.
You should feel when the latching is disengaged, indicating the push-button is reset.
 2. After resetting the emergency stop, restore power to the robot and resume operation.
-

2.9. Movement Without Drive Power

Description

In the unlikely event of an emergency, when powering the robot is either impossible or unwanted, you can use forced back-driving to move the robot arm.

To perform forced back-driving you must push, or pull, the robot arm hard to move the joint. Each joint brake has a friction clutch that enables movement during high forced torque.

Performing forced back-driving requires high force and cannot be performed by one person alone. In clamping situations, two or more people are required to do the forced back-driving. In some situations, two or more people are required to disassemble the robot arm.

See the Service Manual for information about how to disassemble the robot.



WARNING: ELECTRICITY

Electrical hazards and risks, due to the unsupported robot arm breaking or falling apart, can cause injury or death.

- Remove power and support the robot arm before disassembly.



NOTICE

Moving the robot arm manually is intended for urgent emergency and service purposes only. Unnecessary moving of the robot arm can lead to property damage.

- Do not move the joint more than 160 degrees, to ensure the robot can find its original physical position.
- Do not move the joint more than necessary.

2.10. Safety-related Functions and Interfaces

Description

Universal Robots robots are equipped with a range of built-in safety functions as well as safety I/O, digital and analog control signals to or from the electrical interface, to connect to other machines and additional protective devices. Each safety function and I/O is constructed according to EN ISO13849-1 (see [Certifications](#)) with Performance Level d (PLd) using a category 3 architecture. See [17 Software Safety Configuration on page 133](#) in [Part II PolyScope Manual](#), for configuration of the safety functions, inputs and outputs in the user interface. See [17.7 Safety I/O on page 145](#) for descriptions on how to connect safety devices to I/O.



WARNING

The use of safety configuration parameters different from those determined as necessary for risk reduction, can result in hazards that are not reasonably eliminated, or risks that are not sufficiently reduced.

- Ensure tools and grippers are connected correctly to avoid hazards due to interruption of power.



WARNING: ELECTRICITY

Programmer and/or wiring errors can cause the voltage to change from 12V to 24V leading to fire damage to equipment.

- Verify the use of 12V and proceed with caution.

Additional Information



NOTICE

- The use and configuration of safety functions and interfaces must follow the risk assessment procedures for each robot application. (see chapter section)
- The stopping time should be taken into account as part of the application risk assessment
- If the robot detects a fault or violation in the safety system (e.g. if one of the wires in the Emergency Stop circuit is cut or a safety limit is exceeded), then a Stop Category 0 is initiated.



NOTICE

The end effector is not protected by the UR safety system. The functioning of the end effector and/or connection cable is not monitored

2.10.1. Stop Categories

Description

Depending on the circumstances, the robot can initiate three types of stop categories defined according to IEC 60204-1. These categories are defined in the following table.

Stop Category	Description
0	Stop the robot by immediate removal of power.
1	Stop the robot in an orderly, controlled manner. Power is removed once the robot is stopped.
2	*Stop the robot with power available to the drives, while maintaining the trajectory. Drive power is maintained after the robot is stopped.

*Universal Robots robots' Category 2 stops are further described as SS1 or as SS2 type stops according to IEC 61800-5-2.

2.10.2. Configurable Safety Functions

Description

Universal Robots robot safety functions, as listed in the table below, are in the robot but are meant to control the robot system i.e. the robot with its attached tool/end effector. The robot safety functions are used to reduce robot system risks determined by the risk assessment. Positions and speeds are relative to the base of the robot.

Safety Function	Description
Joint Position Limit	Sets upper and lower limits for the allowed joint positions.
Joint Speed Limit	Sets an upper limit for joint speed.
Safety Planes	Defines planes, in space, that limit robot position. Safety planes limit either the tool/end effector alone or both the tool/end effector and the elbow.
Tool Orientation	Defines allowable orientation limits for the tool.
Speed Limit	Limits maximum robot speed. The speed is limited at the elbow, at the tool/end effector flange, and at the center of the user-defined tool/end effector positions.
Force Limit	Limits maximum force exerted by the robot tool/end effector and elbow in clamping situations. The force is limited at the tool/end effector, elbow flange and center of the user-defined tool/end effector positions.
Momentum Limit	Limits maximum momentum of the robot.
Power Limit	Limits mechanical work performed by the robot.
Stopping Time Limit	Limits maximum time the robot uses for stopping after a robot stop is initiated.
Stopping Distance Limit	Limits maximum distance travelled by the robot after a robot stop is initiated.

Safety Function

When performing the application risk assessment, it is necessary to take into account the motion of the robot after a stop has been initiated. In order to ease this process, the safety functions *Stopping Time Limit* and *Stopping Distance Limit* can be used. These safety functions dynamically reduces the speed of the robot motion such that it can always be stopped within the limits. The joint position limits, the safety planes and the tool/end effector orientation limits take the expected stopping distance travel into account i.e. the robot motion will slow down before the limit is reached. The functional safety can be summarized as:

Table

Safety Function	Accuracy	Performance Level	Category
Emergency Stop	-	d	3
Safeguard Stop	-	d	3
Joint Position Limit	5 °	d	3
Joint Speed Limit	1.15 °/s	d	3
Safety Planes	40 mm	d	3
Tool Orientation	3 °	d	3
Speed Limit	50 mm/s	d	3
Force Limit	25 N	d	3
Momentum Limit	3 kg m/s	d	3
Power Limit	10 W	d	3
Stopping Time Limit	50 ms	d	3
Stopping Distance Limit	40 mm	d	3
Safe Home	1.7 °	d	3

Warnings**CAUTION**

Failure to configure the maximum speed limit can result in hazardous situations.

- If the robot is used in manual hand-guiding applications with linear movements, the speed limit must be set to maximum 250 mm/s for the tool/end effector and elbow unless a risk assessment shows that higher speeds are acceptable. This will prevent fast movements of the robot elbow near singularities.

**NOTICE**

There are two exceptions to the force limiting function that are important when designing an application. ()

As the robot stretches out, the knee-joint effect can give high forces in the radial direction (away from the base) at low speeds. Similarly, the short leverage arm, when the tool/end effector is close to the base and moving around the base, can cause high forces at low speeds.

Pinching hazards can be avoided by removing obstacles in these areas, placing the robot differently, or by using a combination of safety planes and joint limits to eliminate the hazard by preventing the robot moving into this region of its workspace.

Workspace

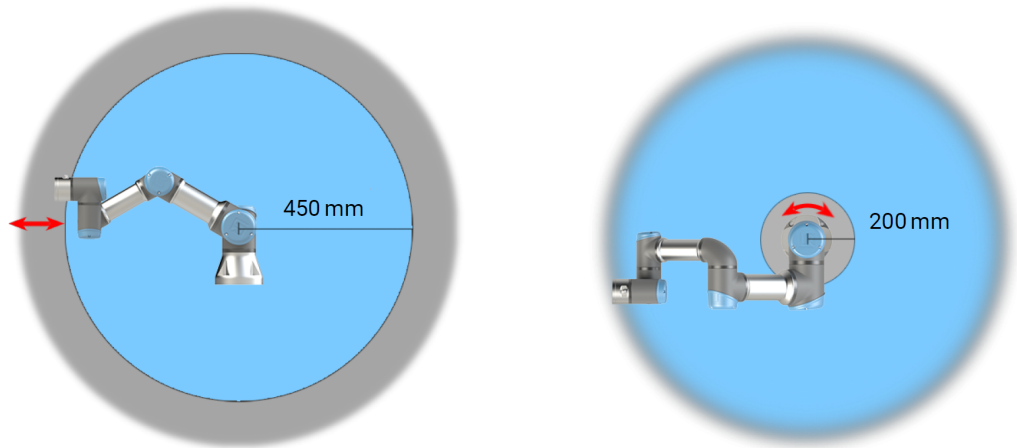

1.1: *Due to the physical properties of the robot arm, certain workspace areas require attention regarding pinching hazards. One area (left) is defined for radial motions when the wrist 1 joint is at least 450 mm from the base of the robot. The other area (right) is within 200 mm of the base of the robot, when moving tangentially.*

Pinching hazards can be avoided by removing obstacles in these areas, by placing the robot differently, or by using a combination of safety planes and joint limits to eliminate the hazards by preventing the robot moving into this region of its workspace.

Safety inputs

The robot also has the following safety inputs:

Safety Input	Description
Emergency Stop Button	Performs a Stop Category 1 (IEC 60204-1) informing other machines using the <i>System Emergency Stop</i> output, if that output is defined. A stop is initiated in anything connected to the output.
Robot Emergency Stop	Performs a Stop Category 1 (IEC 60204-1) via Control Box input, informing other machines using the <i>System Emergency Stop</i> output, if that output is defined.
System Emergency Stop	Performs a Stop Category 1 (IEC 60204-1) on robot only, in all modes and takes precedence over all other commands.
Safeguard Stop	Performs a Stop Category 2 (IEC 60204-1) in all modes, except when using a 3-Position Enabling Device and a mode selector - then when in Manual Mode, the Safeguard Stop can be set to only function in Automatic Mode.
Automatic Mode Safeguard Stop	Performs a Stop Category 2 (IEC 60204-1) in Automatic mode ONLY. <i>Automatic Mode Safeguard Stop</i> can only be selected when a Three-Position Enabling Device is configured and installed.
Safeguard Reset	Returns from the <i>Safeguard Stop</i> state, when a rising edge on the Safeguard Reset input occurs.
Reduced Mode	Transitions the safety system to use the <i>Reduced mode</i> limits.
Three-Position Enabling Device	Initiates a Stop Category 2 (IEC 60204-1) when the enabling device is fully pressed or fully released in manual mode only. Three-Position Enabling Device Stop is triggered when an input goes low. It is unaffected by a Safeguard Reset.
Freedrive on robot	Enables freedrive, when the robot is not in Automatic Mode.
Operational Mode	Switches between Operational modes. The robot is in Automatic mode when input is low, Manual mode when input is high.
Automatic Mode Safeguard Reset	Returns from the <i>Automatic Mode Safeguard Stop</i> state, when a rising edge on the Automatic Mode Safeguard Reset input occurs.

Safety outputs For interfacing with other machines, the robot is equipped with the following safety outputs:

Safety Output	Description
System Emergency Stop	While this signal is logic low, the <i>Robot Emergency Stop</i> input is logic low or the Emergency Stop button is pressed.
Robot Moving	While this signal is logic high, no single joint of the robot moves more than 0.1 rad/s.
Robot Not Stopping	Logic high when the robot is stopped or in the process of stopping due to an Emergency Stop or Safeguard Stop. Otherwise it will be logic low.
Reduced	Logic low when the safety system is in Reduced Mode.
Not Reduced	Logic low when the system is not in Reduced Mode.
Safe Home	Logic high when robot is in the configured Safe Home Position.

All safety I/O are dual channel, meaning they are safe when low (e.g., the Emergency Stop is active when the signals are low).

2.10.3. Safety Functions

Description The safety system acts by monitoring if any of the safety limits are exceeded or if an Emergency Stop or a Safeguard Stop is initiated. The reactions of the safety system are:

Trigger	Reaction
Emergency Stop	Stop Category 1
Safeguard Stop	Stop Category 2
3PE Stop (if a 3-Position Enabling device is connected)	Stop Category 2
Limit Violation	Stop Category 0
Fault Detection	Stop Category 0



NOTICE

If the safety system detects any fault or violation, all safety outputs re-set to low.

2.10.4. Safety Parameter Set

Description

The safety system has the following set of configurable safety parameters:

- Normal
 - Reduced
-

Normal and Reduced

You can set up the safety limits for each set of safety parameters, creating distinct configurations for normal, or higher settings, and reduced. The reduced configuration is active when the tool/end effector is positioned on the reduced side of a Trigger Reduced Plane, or when the reduced configuration is externally triggered by a safety input.

Using a plane to trigger the Reduced configuration: When the robot arm moves from the side of the trigger plane configured with reduced safety parameters, to the side that is configured with normal safety parameters, there is a 20 mm area around the trigger plane where both normal and reduced limits are allowed. This area around the trigger plane prevents nuisance safety stops when the robot is exactly at the limit.

Using an input to trigger the Reduced configuration: When a safety input starts, or stops, the reduced configuration, up to 500 ms can elapse before the new limit values become active. This can happen in either of the following circumstances:

- Switching from the reduced configuration to normal
- Switching from the normal configuration to reduced

The robot arm adapts to the new safety limits within the 500 ms.

Recovery

When a safety limit is exceeded, the safety system must be restarted. For example, if a joint position limit is outside a safety limit, at start-up, Recovery is activated.

You cannot run programs for the robot when recovery is activated, but the robot arm can be manually moved back within limits using Freedrive, or by using the Move tab in PolyScope. (see [Part II PolyScope Manual](#))

The safety limits for Recovery are:

Safety Function	Limit
Joint Speed Limit	30 °/s
Speed Limit	250 mm/s
Force Limit	100 N
Momentum Limit	10 kg m/s
Power Limit	80 W

The safety system issues a Stop Category 0 if a violation of these limits appears.



WARNING

Failure to use caution when moving the robot arm in recovery can lead to hazardous situations.

- Use caution when moving the robot arm back within the limits, as limits for the joint positions, the safety planes, and the tool/end effector orientation are all disabled in recovery.

2.10.5. Modes

Description

When a safety limit is exceeded, the safety system must be restarted. For example, if a joint position limit is outside a safety limit, at start-up, Recovery is activated. You cannot run programs for the robot when recovery is activated, but the robot arm can be manually moved back within limits using Freedrive, or by using the Move tab in PolyScope. (see [Part II PolyScope Manual](#))

Safety limits of Recovery Mode

Safety Function	Limit
Joint Speed Limit	30 °/s
Speed Limit	250 mm/s
Force Limit	100 N
Momentum Limit	10 kg m/s
Power Limit	80 W

The safety system issues a Stop Category 0 if a violation of these limits appears.



WARNING

Failure to use caution when moving the robot arm in recovery can lead to hazardous situations.

- Use caution when moving the robot arm back within the limits, as limits for the joint positions, the safety planes, and the tool/end effector orientation are all disabled in recovery.

3. Mechanical Interface

Description The elements of the robot make up the robot system: Robot arm, tool or workpiece, Control Box and 3PE Teach Pendant are described in this chapter. You can also find maximum payload and workspace requirements.

3.1. Workspace and Operating Space

Description The workspace is the range of the fully extended robot arm, horizontally and vertically. The operating space is the location where the robot is expected to function.



NOTICE

Disregard for the robot workspace and operating space can result in the damage to property.

- Consider the information below when choosing the operating space for the robot.



NOTICE

Moving the tool close to the cylindrical volume can cause the joints to move too fast, leading to loss of functionality and damage to property.

- Do not move the tool close to the cylindrical volume, even when the tool is moving slowly.

Workspace

The cylindrical volume is both directly above and directly below the robot base. The robot extends 500 mm from the base joint.

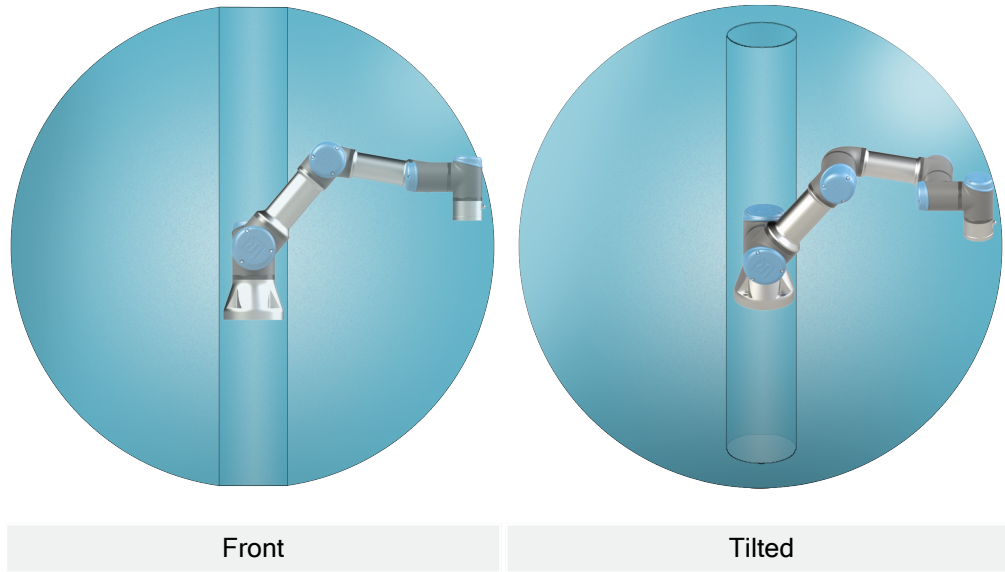

3.2. Mounting Description

Description

Robot arm (Base)	Mounted with four 8.8 strength, 6.6mm bolts and four M6 mounting holes at the base.
Tool (Tool Flange)	Uses four M6 thread holes for attaching a tool to the robot. The M6 bolts shall be tightened with 8 Nm, strength class 8.8. For accurate tool repositioning, use a pin in the Ø6 hole provided.
Control Box	The Control Box can be hung on a wall or placed on the ground.
Teach Pendant	The Teach Pendant is wall mounted or placed onto the Control Box. Verify the cable does not cause tripping hazard. You can buy extra brackets for mounting the Control Box and Teach Pendant.

**Warning:
IP rating**



CAUTION

Mounting and operating the robot in environments exceeding the recommended IP rating can result in injury.

- Mount the robot in an environment suited to the IP rating. The robot must not be operated in environments that exceed those corresponding to the IP ratings of the robot (IP54), Teach Pendant (IP54) and Control Box (IP44)

**Warning:
Mounting**



WARNING

Unstable mounting can lead to accidents.

- Always make sure the robot parts are properly and securely mounted and bolted in place.

3.3. Securing the Robot Arm

Mounting

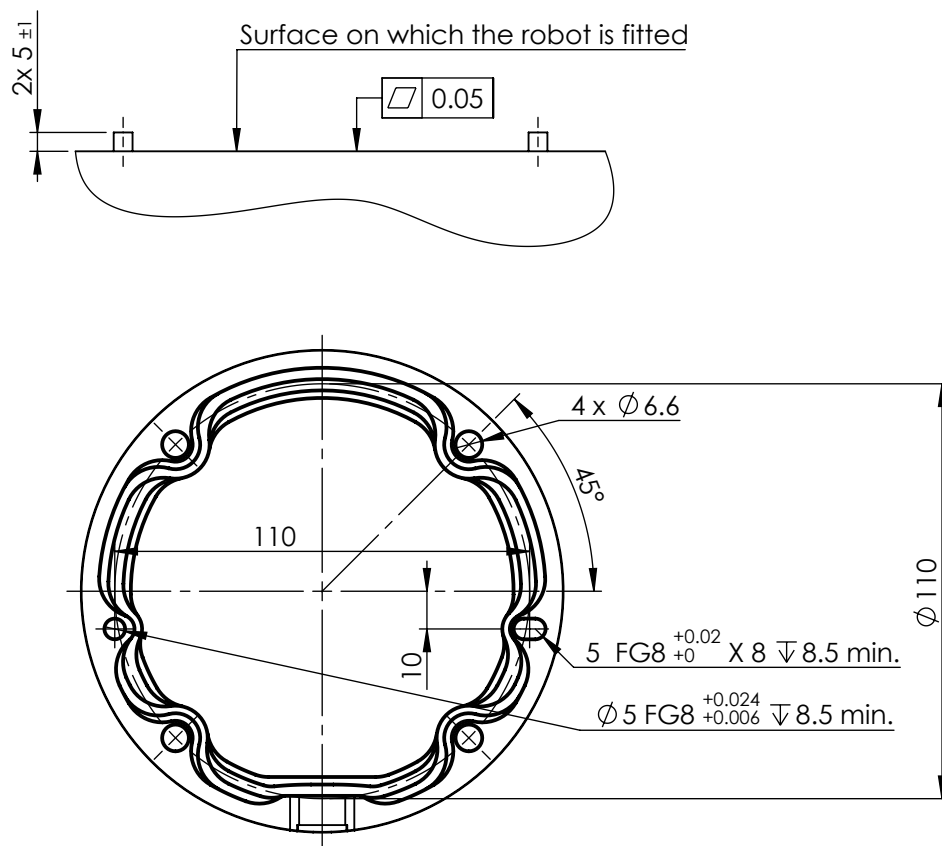

Dimensions and hole pattern for mounting the robot.

**To power down
the robot arm**



WARNING

Unexpected start-up and/or movement can lead to injury

- Power down the robot arm to prevent unexpected start-up during mounting and dismounting.

1. Press the power button on the Teach Pendant to turn off the robot.
2. Unplug the mains cable / power cord from the wall socket.
3. Allow 30 seconds for the robot to discharge any stored energy.

To secure the robot arm

1. Mount the robot on a sturdy, vibration-less, surface that can withstand at least ten times the full torque of the base joint and at least five times the weight of the robot arm.
If the robot is mounted on a linear axis, or a moving platform, then the acceleration of the moving mounting base is very low. High acceleration might cause the robot to make a safety stop.
2. Tighten the bolts to 20 Nm torque. (Torque values have been updated SW5.14. Earlier printed version will show different values)
3. Use the two Ø8 holes provided, with a pin, to accurately reposition robot arm.

3.4. Securing Tool

Description

The tool or workpiece is mounted to the tool output flange (ISO 9409-1) at the tip of the robot. All measurements are in millimeters.

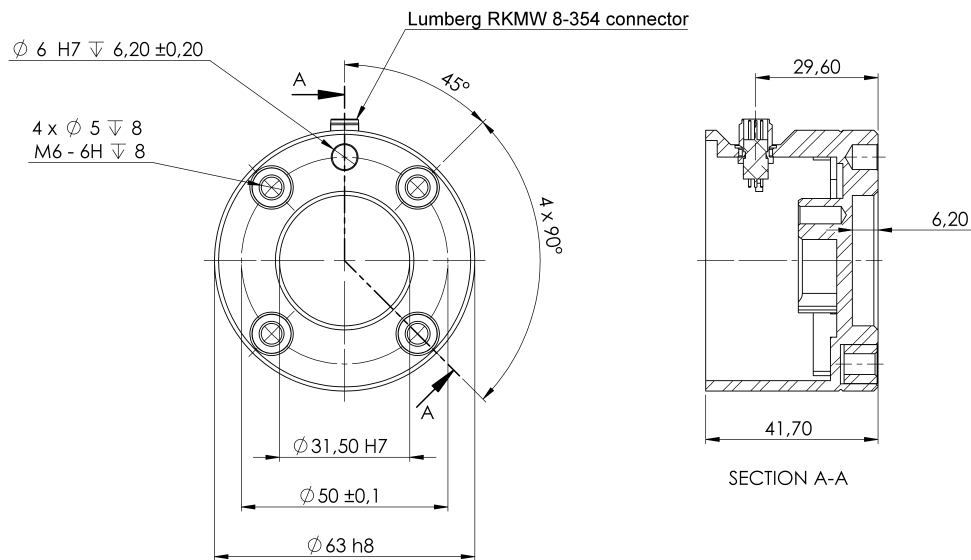

1.2: Dimensions and hole pattern of the tool. All measurements are in millimeters.

Tool flange

The tool output flange (ISO 9409-1) is where the tool is mounted at the tip of the robot. It is recommended to use a radially slotted hole for the positioning pin to avoid over-constraining, while keeping precise position.



CAUTION
 Very long M8 bolts can press against the bottom of the tool flange and short circuit the robot.

- Do not use bolts that extend beyond 10 mm to mount the tool.



WARNING

Failure to tighten bolts properly cause injury due to loss of the adapter flange and/or end effector.

- Ensure the tool is properly and securely bolted in place.
- Ensure the tool is constructed such that it cannot create a hazardous situation by dropping a part unexpectedly.

3.5. Control Box Clearance

Description

The flow of hot air in the Control Box can result in equipment malfunction. The Control Box requires a minimum clearance of 50 mm on each side for sufficient cool airflow. The recommended Control Box clearance is 200 mm.



WARNING

A wet Control Box can cause fatal injury.

- Make sure the Control Box and cables do not come into contact with liquids.
- Place the Control Box (IP44) in an environment suited for the IP rating.

3.6. Maximum Payload

Description

The rated payload of the Robot Arm depends on the *center of gravity offset* of the payload, see [Figure 3 Mechanical Interface on page 38](#)

The center of gravity offset is defined as the distance from the center of the tool flange to the center of gravity of the attached payload.

When computing the payload mass in a pick and place application, for example, consider both the gripper and object handled by the gripper.

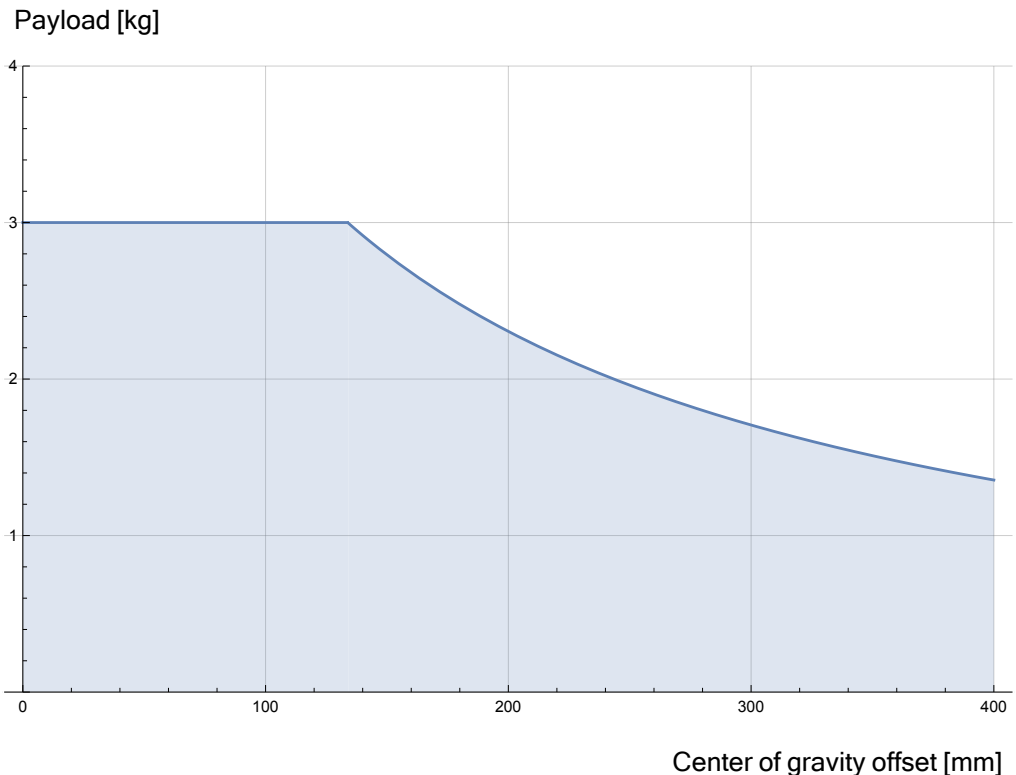

1.3: *The relationship between the rated payload and the center of gravity offset.*

Payload Inertia

The robot can be used with high inertia payloads. The control software automatically adjusts accelerations, if you correctly enter the following in PolyScope (see: [19.7.10 Set Payload on page 233](#)):

- Payload mass
- Center of gravity
- Inertia

You can use the URSim to evaluate the accelerations and cycle times of the robot motions with a specific payload.

4. Electrical Interface

Description

The robot arm and the Control Box contain electrical interface groups. Examples are given for most types of I/O. The term I/O refers to both digital and analog control signals to or from the electrical interface groups listed below.

- Mains connection
- Robot connection
- Controller I/O
- Tool I/O
- Ethernet

All voltages and currents are in Direct Current (DC) unless otherwise specified.

4.1. Electrical Warnings and Cautions

Warnings

Observe the following warnings for all the interface groups, including when you design and install an application.

PLC



WARNING

Failure to follow any of the below can result in serious injury or death, as the safety functions could be overridden.

- Never connect safety signals to a PLC that is not a safety PLC with the correct safety level. It is important to keep safety interface signals separated from the normal I/O interface signals.
- All safety-related signals shall be constructed redundantly (two independent channels).
- Keep the two independent channels separate so a single fault cannot lead to loss of the safety function.

Electricity**WARNING: ELECTRICITY**

Failure to follow any of the below can result in serious injury or death due to electrical hazards.

- Make sure all equipment not rated for water exposure remain dry. If water is allowed to enter the product, lockout-tagout all power and then contact your local Universal Robots service provider for assistance.
- Only use the original cables supplied with the robot only. Do not use the robot for applications where the cables are subject to flexing.
- Use caution when installing interface cables to the robot I/O. The metal plate in the bottom is intended for interface cables and connectors. Remove the plate before drilling holes. Make sure that all shavings are removed before reinstalling the plate. Remember to use correct gland sizes.

EMC**CAUTION**

Disturbing signals with levels higher than those defined in the specific IEC standards can cause unexpected behaviors from the robot. Be aware of the following:

- The robot has been tested according to international IEC standards for **ElectroMagnetic Compatibility (EMC)**. Very high signal levels or excessive exposure can damage the robot permanently. EMC problems are found to happen usually in welding processes and are normally prompted by error messages in the log. Universal Robots cannot be held responsible for any damages caused by EMC problems.
- I/O cables going from the Control Box to other machinery and factory equipment may not be longer than 30m, unless additional tests are performed.

Ground**GROUND**

Negative connections are referred to as Ground (GND) and are connected to the casing of the robot and the Control Box. All mentioned GND connections are only for powering and signalling. For PE (Protective Earth) use the M6-size screw connections marked with earth symbols inside the Control Box. The grounding conductor shall have at least the current rating of the highest current in the system.

The manual**READ MANUAL**

Some I/Os inside the Control Box can be configured for either normal or safety-related I/O. Read and understand the complete Electrical Interface chapter.

4.2. Controller I/O

Description

You can use the I/O inside the Control Box for a wide range of equipment including pneumatic relays, PLCs and emergency stop buttons. The illustration below shows the layout of electrical interface groups inside the Control Box.

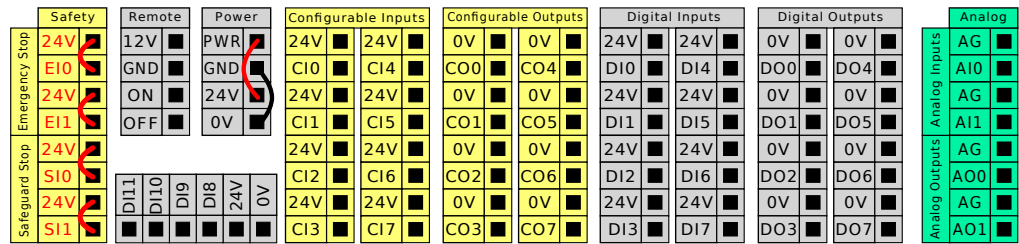

You can use the horizontal Digital Inputs block (DI8-DI11), illustrated below, for quadrature encoding Conveyor Tracking (see [Common specifications for all digital I/O on the facing page](#)) for these types of input.



The meaning of the color schemes listed below must be observed and maintained.

Yellow with red text	Dedicated safety signals
Yellow with black text	Configurable for safety
Gray with black text	General purpose digital I/O
Green with black text	General purpose analog I/O

In the GUI, you can set up **configurable I/O** as either **safety-related I/O** or **general purpose I/O** (see part [Part II PolyScope Manual](#)).

Common specifications for all digital I/O

This section defines electrical specifications for the following 24V digital I/O of the Control Box.

- Safety I/O.
- Configurable I/O.
- General purpose I/O.



NOTICE

The word **configurable** is used for I/O configured as either safety-related I/O or normal I/O. These are the yellow terminals with black text.

Install the robot according to the electrical specifications which are the same for all three inputs.

It is possible to power the digital I/O from an internal 24V power supply or from an external power source by configuring the terminal block called **Power**. This block consists of four terminals. The upper two (PWR and GND) are 24V and ground from the internal 24V supply. The lower two terminals (24V and 0V) in the block are the 24V input to supply the I/O. The default configuration uses the internal power supply (see below).

Power supply

If more current is needed, connect an external power supply as shown below.

<p>This example illustrates the default configuration using the internal power supply</p>	<p>This example illustrates the default configuration with an external power supply for more current.</p>

The electrical specifications for both the internal and external power supply are shown below.

Terminals	Parameter	Min	Typ	Max	Unit
<i>Internal 24V power supply</i>					
[PWR - GND]	Voltage	23	24	25	V
[PWR - GND]	Current	0	-	2*	A
<i>External 24V input requirements</i>					
[24V - 0V]	Voltage	20	24	29	V
[24V - 0V]	Current	0	-	6	A

*3.5A for 500ms or 33% duty cycle.

Digital I/Os

The digital I/O are constructed in compliance with IEC 61131-2. The electrical specifications are shown below.

Terminals	Parameter	Min	Typ	Max	Unit
<i>Digital Outputs</i>					
[COx / DOx]	Current*	0	-	1	A
[COx / DOx]	Voltage drop	0	-	0.5	V
[COx / DOx]	Leakage current	0	-	0.1	mA
[COx / DOx]	Function	-	PNP	-	Type
[COx / DOx]	IEC 61131-2	-	1A	-	Type
<i>Digital Inputs</i>					
[EIx/SIx/CIx/DIx]	Voltage	-3	-	30	V
[EIx/SIx/CIx/DIx]	OFF region	-3	-	5	V
[EIx/SIx/CIx/DIx]	ON region	11	-	30	V
[EIx/SIx/CIx/DIx]	Current (11-30V)	2	-	15	mA
[EIx/SIx/CIx/DIx]	Function	-	PNP +	-	Type
[EIx/SIx/CIx/DIx]	IEC 61131-2	-	3	-	Type

*For resistive loads or inductive loads of maximum 1H.

4.3. Safety I/O

Safety I/O

This section describes dedicated safety input (Yellow terminal with red text) and configurable I/O (Yellow terminals with black text) when configured as safety I/O. Follow the common specifications for all digital I/O in section [4.3 Safety I/O above](#).

Safety devices and equipment must be installed according to the safety instructions and the risk assessment in chapter [Safety](#).

All safety I/O are paired (redundant), so a single fault does not cause loss of the safety function. However, the safety I/O must be kept as two separate branches.

The permanent safety input types are:

- **Robot Emergency Stop** for emergency stop equipment only
- **Safeguard Stop** for protective devices
- **3PE Stop** for protective devices

Table The functional difference is shown below.

	Emergency Stop	Safeguard Stop	3PE Stop
Robot stops moving	Yes	Yes	Yes
Program execution	Pauses	Pauses	Pauses
Drive power	Off	On	On
Reset	Manual	Automatic or manual	Automatic or manual
Frequency of use	Infrequent	Every cycle to infrequent	Every cycle to infrequent
Requires re-initialization	Brake release only	No	No
Stop Category (IEC 60204-1)	1	2	2
Performance level of monitoring function (ISO 13849-1)	PLd	PLd	PLd

Safety caution Use the configurable I/O to set up additional safety I/O functionality, e.g. Emergency Stop Output. Configuring a set of configurable I/O for safety functions are done through the GUI, (see part Part II PolyScope Manual).



CAUTION

Failure to verify and test the safety functions regularly can lead to hazardous situations.

- Safety functions shall be verified before putting the robot into operation.
- Safety functions shall be tested regularly.

OSSD signals All configured and permanent safety inputs are filtered to allow the use of OSSD safety equipment with pulse lengths under 3ms. The safety input is sampled every millisecond and the state of the input is determined by the most frequently seen input signal over the last 7 milliseconds. OSSD pulses on the safety outputs are detailed in part Part II PolyScope Manual.

Default safety configuration

The robot is delivered with a default configuration, which enables operation without any additional safety equipment (see illustration below).

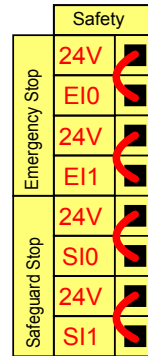

Connecting emergency stop buttons

Most applications require one or more extra emergency stop buttons. The illustration below shows how one or more emergency stop buttons can be connected.

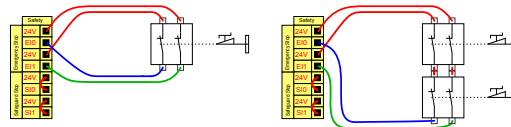

Sharing the Emergency Stop with other machines

You can set up a shared emergency stop function between the robot and other machines by configuring the following I/O functions via the GUI. The Robot Emergency Stop Input cannot be used for sharing purposes. If more than two UR robots or other machines need to be connected, a safety PLC must be used to control the emergency stop signals.

- Configurable input pair: External emergency stop.
- Configurable output pair: System emergency stop.

The illustration below shows how two UR robots share their emergency stop functions. In this example the configured I/Os used are CI0-CI1 and CO0-CO1.

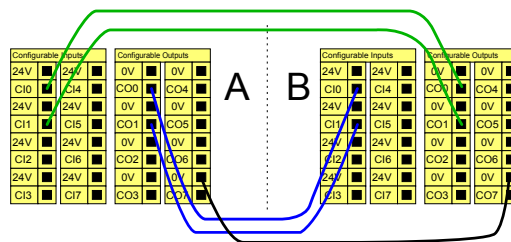

Copyright © 2009-2024 by Universal Robots A/S. All rights reserved.

Safeguard stop with automatic resume

This configuration is only intended for applications where the operator cannot go through the door and close it behind him. The configurable I/O is used to setup a reset button outside the door to reactivate robot motion. The robot resumes movement automatically when the signal is re-established.



WARNING

Do not use this configuration if signal can be re-established from the inside of the safety perimeter.

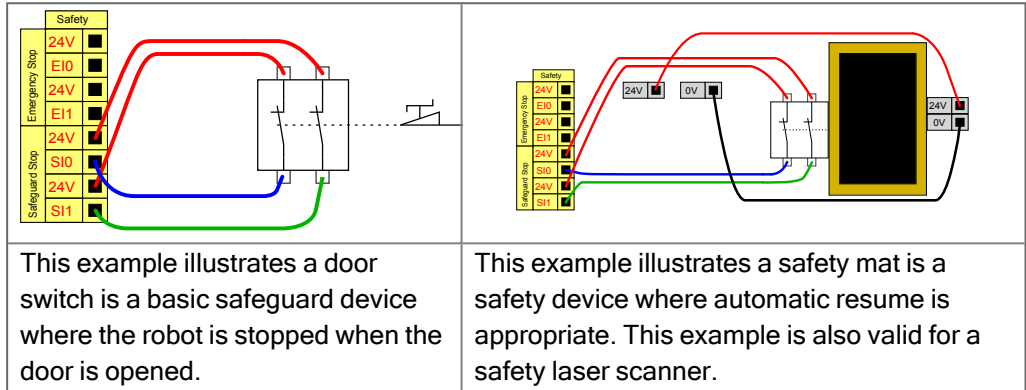

Safeguard Stop with reset button

If the safeguard interface is used to interact with a light curtain, a reset outside the safety perimeter is required. The reset button must be a two channel type. In this example the I/O configured for reset is C10-C11 (see below).

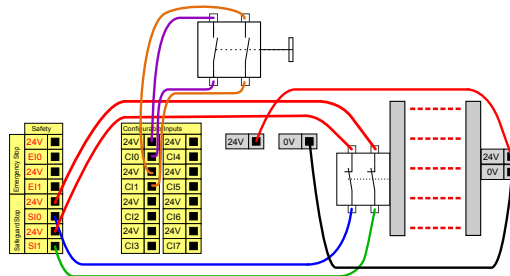

4.4. Three Position Enabling Device

Description

The robot arm is equipped with an enabling device in the form of the 3PE Teach Pendant.

The Control Box safely supports the following enabling device configurations:

- 3PE Teach Pendant
- External Three-Position Enabling device
- External Three-Position device and 3PE Teach Pendant

The standard Teach Pendant is not supported by the UR20 and UR30 robots.

The illustration below shows how to connect a Three-Position Enabling device. See [Teach Pendant with 3-Position Enabling Device](#) chapter for more.

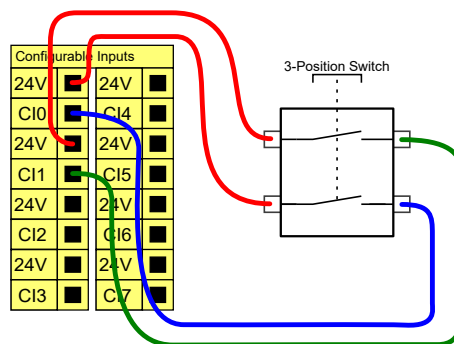

Note: The two input channels for the Three-Position Enabling Device input have a disagreement tolerance of 1 second.



NOTICE

The Universal Robots e-Series safety system does not support multiple external Three-Position Enabling Devices.

Operational Mode Switch

Using a Three-Position Enabling device requires the use of an Operational Mode switch.

The illustration below shows an Operational Mode switch. See [16.9 Operational Mode Selection](#) on page 130

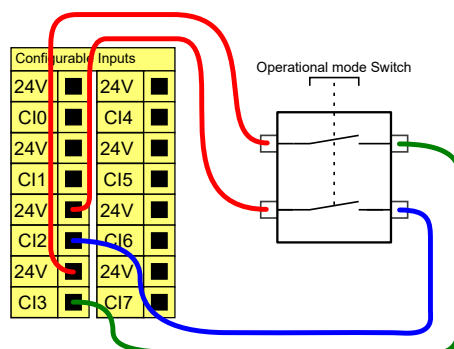

4.5. General Purpose Digital I/O

Description The Startup screen contains settings for automatically loading and starting a default program, and for auto-initializing the Robot arm during power up.

General purpose digital I/O This section describes the general purpose 24V I/O (Gray terminals) and the configurable I/O (Yellow terminals with black text) when not configured as safety I/O. The common specifications in section 4.5 General Purpose Digital I/O above must be observed.

The general purpose I/O can be used to drive equipment like pneumatic relays directly or for communication with other PLC systems. All Digital Outputs can be disabled automatically when program execution is stopped, see part Part II PolyScope Manual. In this mode, the output is always low when a program is not running. Examples are shown in the following subsections.

These examples use regular Digital Outputs but any configurable outputs could also have be used if they are not configured to perform a safety function.

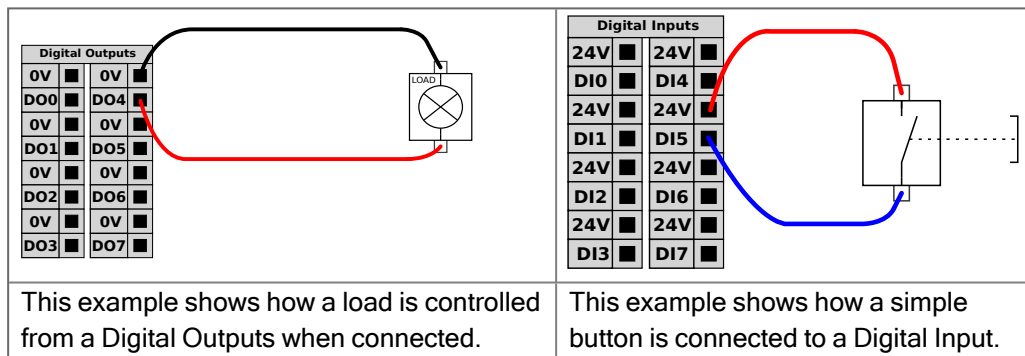

Communication with other machines or PLCs You can use the digital I/O to communicate with other equipment if a common GND (0V) is established and if the machine uses PNP technology, see below.

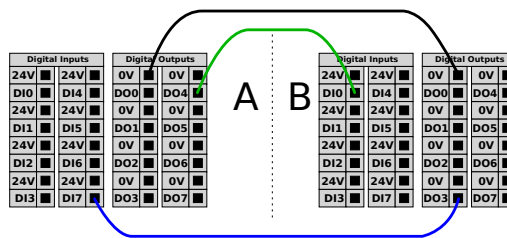

Copyright © 2009-2024 by Universal Robots A/S. All rights reserved.

4.6. General Purpose Analog I/O

Description

The analog I/O interface is the green terminal. It is used to set or measure voltage (0-10V) or current (4-20mA) to and from other equipment.

The following directions is recommended to achieve the highest accuracy.

- Use the AG terminal closest to the I/O. The pair share a common mode filter.
- Use the same GND (0V) for equipment and Control Box. The analog I/O is not galvanically isolated from the Control Box.
- Use a shielded cable or twisted pairs. Connect the shield to the GND terminal at the terminal called **Power**.
- Use equipment that works in current mode. Current signals are less sensitive to interferences.

Electrical Specifications

In the GUI you can select input modes (see part [Part II PolyScope Manual](#)). The electrical specifications are shown below.

Terminals	Parameter	Min	Typ	Max	Unit
<i>Analog Input in current mode</i>					
[AIx - AG]	Current	4	-	20	mA
[AIx - AG]	Resistance	-	20	-	ohm
[AIx - AG]	Resolution	-	12	-	bit
<i>Analog Input in voltage mode</i>					
[AIx - AG]	Voltage	0	-	10	V
[AIx - AG]	Resistance	-	10	-	Kohm
[AIx - AG]	Resolution	-	12	-	bit
<i>Analog Output in current mode</i>					
[AOx - AG]	Current	4	-	20	mA
[AOx - AG]	Voltage	0	-	24	V
[AOx - AG]	Resolution	-	12	-	bit
<i>Analog Output in voltage mode</i>					
[AOx - AG]	Voltage	0	-	10	V
[AOx - AG]	Current	-20	-	20	mA
[AOx - AG]	Resistance	-	1	-	ohm
[AOx - AG]	Resolution	-	12	-	bit

Analog Output and Analog Input

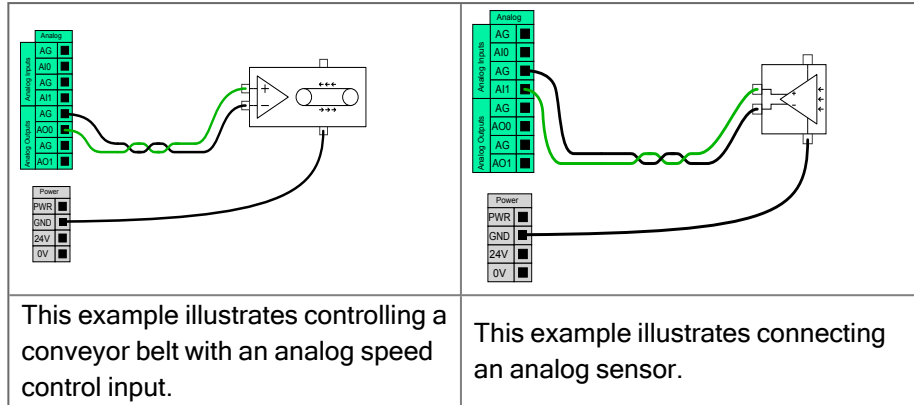

This example illustrates controlling a conveyor belt with an analog speed control input.

This example illustrates connecting an analog sensor.

4.7. Remote ON/OFF Control

Description

Use remote **ON/OFF** control to turn the Control Box on and off without using the Teach Pendant. It is typically used:

- When the Teach Pendant is inaccessible.
- When a PLC system must have full control.
- When several robots must be turned on or off at the same time.

Remote Control

The remote **ON/OFF** control provides a auxiliary 12V supply, kept active when the Control Box is turned off. The **ON** input is intended only for short time activation and works in the same way as the **POWER** button. The **OFF** input can be held down as desired. Use a software feature to load and start programs automatically (see part [Part II PolyScope Manual](#)).

The electrical specifications are shown below.

Terminals	Parameter	Min	Typ	Max	Unit
[12V - GND]	Voltage	10	12	13	V
[12V - GND]	Current	-	-	100	mA
[ON / OFF]	Inactive voltage	0	-	0.5	V
[ON / OFF]	Active voltage	5	-	12	V
[ON / OFF]	Input current	-	1	-	mA
[ON]	Activation time	200	-	600	ms

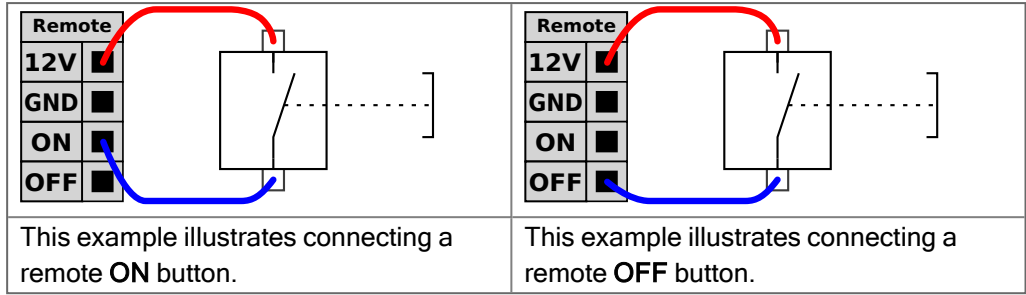

	<p>CAUTION</p> <p>Maintaining a press and hold on the power button switches the Control Box OFF without saving.</p> <ul style="list-style-type: none"> Do not press and hold the ON input or the POWER button without saving. Use the OFF input for remote off control to allow the Control Box to save open files and shut down correctly.
---	---

4.8. Control Box Bracket

Description

On the underside of the I/O interface groups, there is a bracket with ports that allows for additional connections (illustrated below). The base of the Control Box has a capped opening for easy connection (see Ethernet).

The Mini Displayport supports monitors with Displayport and requires an active Mini Display to DVI or HDMI converter to connect monitors with DVI/HDMI interface. Passive converters do not work with DVI/HDMI ports.

Bracket

The Fuse must be UL marked, Mini Blade type with maximum current rating: 10A and minimum voltage rating: 32V

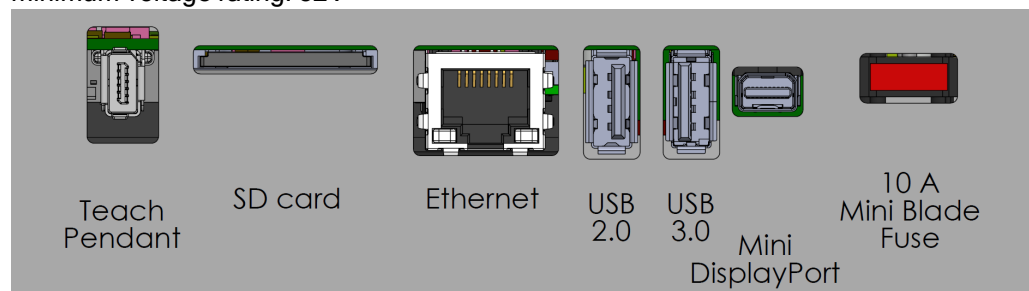

NOTICE

Do not connect or disconnect the Teach Pendant while Control Box is powered on. This can cause damage to Control Box.



NOTICE

Failure to plug in the active adapter before attempting to power on the Control Box can hinder the display output.

- Plug in the active adapter to the Control Box before powering on the system.
- In some cases the external monitor must be powered on before the Control Box.
- Use an active adapter that supports revision 1.2 as not all adapters function out-of-the-box.

4.9. Ethernet

Description

The Ethernet interface can be used for:

- MODBUS, EtherNet/IP and PROFINET (see part [Part II PolyScope Manual](#)).
- Remote access and control.

To connect the Ethernet cable by passing it through the hole at the base of the Control Box, and plugging it into the Ethernet port on the underside of the bracket. Replace the cap at the base of the Control Box with an appropriate cable gland to connect the cable to the Ethernet port.



The electrical specifications are shown in the table below.

Parameter	Min	Typ	Max	Unit
Communication speed	10	-	1000	Mb/s

4.10. Mains Connections

Description

The mains cable from the Control Box has a standard IEC plug at the end. Connect a country specific mains plug, or cable, to the IEC plug.



NOTICE

- IEC 61000-6-4:Chapter 1 scope: “This part of IEC 61000 for emission requirement applies to electrical and electronic equipment intended for use within the environment of existing at industrial (see 3.1.12) locations.”
- IEC 61000-6-4:Chapter 3.1.12 industrial location: “Locations characterized by a separate power network, supplied from a high- or medium-voltage transformer, dedicated for the supply of the installation”

Mains connections

To power the robot, the Control Box shall be connected to the mains via the supplied power cord. The IEC C13 connector on the power cord connects to the IEC C14 appliance inlet at the bottom of the Control Box.



NOTICE

Always use a power cord with a country specific wall plug when connecting to the Control Box. Do not use an adapter.

As a part of the electrical installation, provide the following:

- Connection to ground
- Main fuse
- Residual current device
- A lockable (in the OFF position) switch

A main switch shall be installed to power off all equipment in the robot application as an easy means for lockout. The electrical specifications are shown in the table below.

Table

Parameter	Min	Typ	Max	Unit
Input voltage	90	-	264	VAC
External mains fuse (90-200V)	8	-	16	A
External mains fuse (200-264V)	8	-	16	A
Input frequency	47	-	440	Hz
Stand-by power	-	-	<1.5	W
Nominal operating power	90	150	325	W

Electrical hazards



WARNING: ELECTRICITY

Failure to follow any of the below can result in serious injury or death due to electrical hazards.

- Ensure the robot is grounded correctly (electrical connection to ground). Use the unused bolts associated with grounding symbols inside the Control Box to create common grounding of all equipment in the system. The grounding conductor shall have at least the current rating of the highest current in the system.
- Ensure the input power to the Control Box is protected with a Residual Current Device (RCD) and a correct fuse.
- Lockout all power for the complete robot installation during service.
- Ensure other equipment shall not supply power to the robot I/O when the robot is locked out.
- Ensure all cables are connected correctly before the Control Box is powered. Always use the original power cord.

4.11. Robot Connections: Robot Cable

Description

This subsection describes the connection for a robot arm configured with a fixed 6 meter Robot Cable. For information on connecting a robot arm configured with a Base Flange Cable connector, see [4.11 Robot Connections: Robot Cable](#) above.

Connect arm and Control box

Establish the robot connection by connecting the robot arm to the Control Box with the Robot Cable.

Plug and lock the cable from the robot into the connector at the bottom of the Control Box (see illustration below). Twist the connector twice to ensure it is properly locked before turning on the robot arm.

You can turn the connector to the right to make it easier to lock after the cable is plugged in.



CAUTION

Improper robot connection can result in loss of power to the robot arm.

- Do not disconnect the Robot Cable when the robot arm is turned on.
- Do not extend or modify the original Robot Cable.

4.12. Robot Connections: Base Flange Cable

Description

This subsection describes the connection for a robot arm configured with a Base Flange Cable connector. For information on connecting a robot arm configured with a fixed 6 meter Robot Cable, see [4.12 Robot Connections: Base Flange Cable above](#).

Base Flange Cable connector

The Base Flange Cable connector establishes the robot connection by connecting the robot arm to the Control Box. The Robot Cable connects to the Base Flange Cable connector on one end, and to the Control Box connector on the other end. You can lock each connector when robot connection is established.



CAUTION

The maximum robot connection from the robot arm to the Control Box is 6 m. Improper robot connection can result in loss of power to the robot arm.

- Do not extend a 6 m Robot Cable.



NOTICE

Connecting the Base Flange Cable directly to any Control Box can result in equipment or property damage.

- Do not connect the Base Flange Cable directly to the Control Box.

4.13. Tool I/O

Description

Adjacent to the tool flange on Wrist #3, there is an eight-pinned connector that provides power and control signals for different grippers and sensors that can be attached to the robot. The Lumberg RKMV 8-354 is a suitable industrial cable. Each of the eight wires inside the cable have different colors representing different functions.

This connector provides power and control signals for grippers and sensors used on a specific robot tool. The industrial cable listed below is suitable:

- Lumberg RKMV 8-354.



NOTICE

The Tool Connector must be manually tightened up to a maximum of 0.4Nm.

The eight wires inside the cable have different colors that designate different functions. See table below:

Color	Signal	Description
Red	GND	Ground
Gray	POWER	0V/12V/24V
Blue	TO0/PWR	Digital Outputs 0 or 0V/12V/24V
Pink	TO1/GND	Digital Outputs 1 or Ground
Yellow	TI0	Digital Inputs 0
Green	TI1	Digital Inputs 1
White	AI2 / RS485+	Analog in 2 or RS485+
Brown	AI3 / RS485-	Analog in 3 or RS485-

Access Tool I/O in the Installation Tab (see part [Part II PolyScope Manual](#)) to set the internal power supply to 0V, 12V or 24V. The electrical specifications are shown below:

Parameter	Min	Typ	Max	Unit
Supply voltage in 24V mode	23.5	24	24.8	V
Supply voltage in 12V mode	11.5	12	12.5	V
Supply current (single pin)*	-	600	2000**	mA
Supply current (dual pin)*	-	600	2000**	mA
Supply capacitive load	-	-	8000***	uF

*It is highly recommended to use a protective diode for inductive loads.



NOTICE

The tool flange is connected to GND (same as the red wire).

4.14. Tool Power Supply

Description

Access Tool I/O in the Installation Tab (see part [Part II PolyScope Manual](#)) to set the internal power supply to 0V, 12V or 24V.

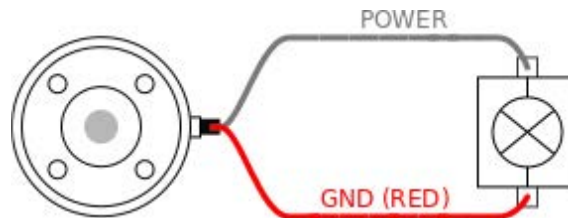

Dual Pin Power Supply

In Dual Pin Power mode, the output current can be increased as listed in ([4.14 Tool Power Supply](#) above table two).

1. In the Header, tap **Installation**.
2. In the list on the left, tap **General**.
3. Tap **TOOL IO** and select **Dual Pin Power**.
4. Connect the wires Power (gray) to TO0 (blue) and Ground (red) to TO1 (pink).

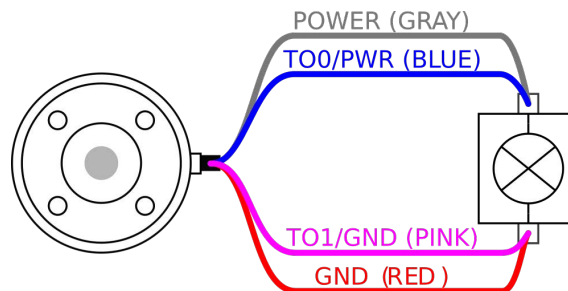

NOTICE

Once the robot makes an Emergency Stop, the voltage is set to 0V for both Power Pins (power is off).

4.15. Tool Digital Outputs

Description

Digital Outputs support three different modes:

Mode	Active	Inactive
Sinking (NPN)	Low	Open
Sourcing (PNP)	High	Open
Push / Pull	High	Low

Access Tool I/O in the Installation Tab (see part [Part II PolyScope Manual](#)) to configure the output mode of each pin. The electrical specifications are shown below:

Parameter	Min	Typ	Max	Unit
Voltage when open	-0.5	-	26	V
Voltage when sinking 1A	-	0.08	0.09	V
Current when sourcing/sinking	0	600	1000	mA
Current through GND	0	1000	3000*	mA



NOTICE

Once the robot makes an Emergency Stop, the Digital Outputs (DO0 and DO1) are deactivated (High Z).



CAUTION

The Digital Outputs in the tool are not current-limited. Overriding the specified data can cause permanent damage.

Using Tool Digital Outputs

This example illustrates turning on a load using the internal 12V or 24V power supply. The output voltage at the I/O tab must be define. There is voltage between the POWER connection and the shield/ground, even when the load is turned off.

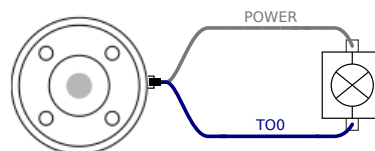

It is recommended to use a protective diode for inductive loads, as shown below.

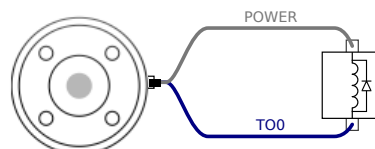

4.16. Tool Digital Inputs

Description The Startup screen contains settings for automatically loading and starting a default program, and for auto-initializing the Robot arm during power up.

Table The Digital Inputs are implemented as PNP with weak pull-down resistors. This means that a floating input always reads as low. The electrical specifications are shown below.

Parameter	Min	Type	Max	Unit
Input voltage	-0.5	-	26	V
Logical low voltage	-	-	2.0	V
Logical high voltage	5.5	-	-	V
Input resistance	-	47k	-	Ω

Using the Tool Digital Inputs This example illustrates connecting a simple button.

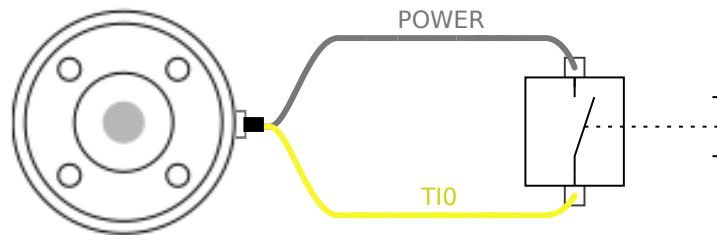

4.17. Tool Analogue Inputs

Description Tool Analogue Input are non-differential and can be set to either voltage (0-10V) or current (4-20mA) on the I/O tab (see part [Part II PolyScope Manual](#)). The electrical specifications are shown below.

Parameter	Min	Type	Max	Unit
Input voltage in voltage mode	-0.5	-	26	V
Input resistance @ range 0V to 10V	-	10.7	-	k Ω
Resolution	-	12	-	bit
Input voltage in current mode	-0.5	-	5.0	V
Input current in current mode	-2.5	-	25	mA
Input resistance @ range 4mA to 20mA	-	182	188	Ω
Resolution	-	12	-	bit

Two examples of using Analog Input are shown in the following subsections.

Caution



CAUTION

Analog Inputs are not protected against over voltage in current mode. Exceeding the limit in the electrical specification can cause permanent damage to the input.

**Using Tool
Analog Inputs,
Non-differential**

This example shows an analog sensor connection with a non-differential output. The sensor output can be either current or voltage, as long as the input mode of that Analog Input is set to the same on the I/O tab.

Note: You can check that a sensor with voltage output can drive the internal resistance of the tool, or the measurement might be invalid.

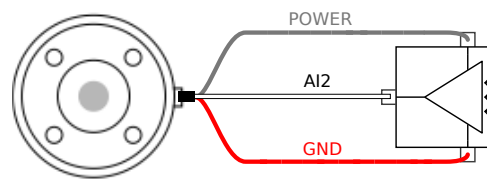

**Using Tool
Analog Inputs,
differential**

This example shows an analog sensor connection with a differential output. Connecting the negative output part to GND (0V), works in the same way as a non-differential sensor.

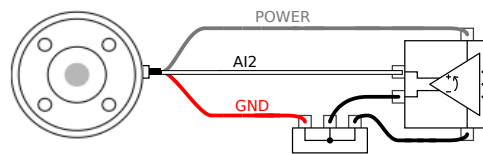

4.18. Tool Communication I/O

Description

- **Signal requests** The RS485 signals use internal fail-safe biasing. If the attached device does not support this fail-safe, signal biasing must either be done in the attached tool, or added externally by adding pull-up resistors to RS485+ and pull-down to RS485-.
- **Latency** The latency of messages sent via the tool connector ranges from 2ms to 4ms, from the time the message is written on the PC to the start of the message on the RS485. A buffer stores data sent to the tool connector until the line goes idle. Once 1000 bytes of data have been received, the message is written on the device.

Baud Rates	9.6k, 19.2k, 38.4k, 57.6k, 115.2k, 1M, 2M, 5M
Stop Bits	1, 2
Parity	None, Odd, Even

5. Transportation

Description

Only transport the robot in its original packaging. Save the packaging material in a dry place if you want to move the robot later.
When moving the robot from its packaging to the installation space, hold both tubes of the robot arm at the same time. Hold the robot in place until all mounting bolts are securely tightened at the base of the robot.
Lift the Control Box by its handle.

Warning: Lifting



WARNING

Incorrect lifting techniques, or using improper lifting equipment, can lead to injury.

- Avoid overloading your back or other body parts when lifting the equipment.
- Use proper lifting equipment.
- All regional and national lifting guidelines shall be followed.
- Make sure to mount the robot according to the instructions in Mechanical Interface.



NOTICE

If the robot is attached to 3rd-party application / installation during transport, please refer to the following:

- Transporting the robot without its original packaging will void all warranties from Universal Robots A/S.
- If the robot is transported attached to a 3rd-party application / installation, follow the recommendations for transporting the robot without the original transport packaging.

Disclaimer

Universal Robots cannot be held responsible for any damage caused by transportation of the equipment.

You can see the recommendations for transportation without packaging at:

myur.universal-robots.com/manuals

5.1. Transport Without Packaging

Description

Universal Robots always recommends transporting the robot in its original packaging. These recommendations are written to reduce unwanted vibrations in joints and brake systems and reduce joint rotation.

If the robot is transported without its original packaging, then please refer to the following guidelines:

- Fold the robot as much as possible - do not transport the robot in the singularity position.
- Move the center of gravity in the robot as close to the base as possible.
- Secure each tube to a solid surface on two different points on the tube.
- Secure any attached end effector rigidly in 3 axes.

Transport

Fold the robot as much as possible.

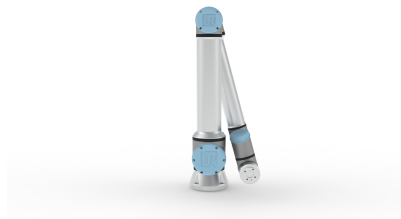

Do not transport extended. (singularity position)

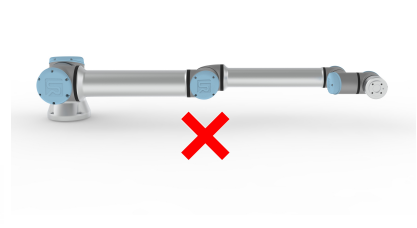
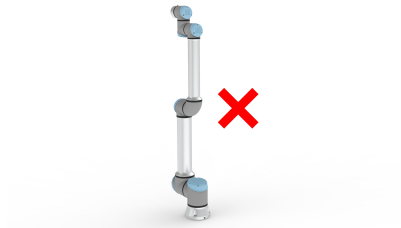

Secure the tubes to a solid surface. Secure attached end effector in 3 axes.

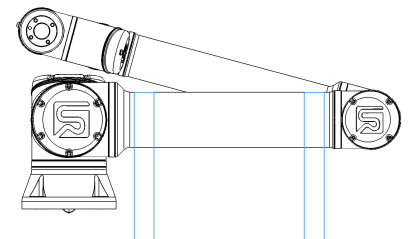
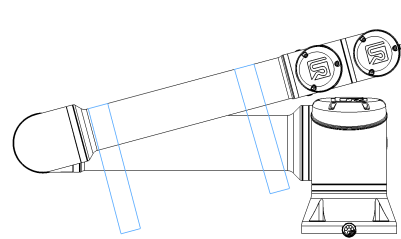

6. Maintenance and Repair

Description

Perform any visual or working condition inspection, in compliance with all safety instructions in this manual.

Conduct all maintenance, inspection, calibration and repair work according to the latest version of Service Manual on the support website: <http://www.universal-robots.com/support>.

Repair work must only be done by Universal Robots or authorized system integrators. Client designated, trained individuals can also do repair work, provided they follow the inspection plan outlined in the Service Manual. See the Service Manual: Chapter 5 for full inspection plan for trained individuals

All parts returned to Universal Robots shall be returned according to terms in the Service Manual.

Safety for Maintenance

After maintenance and repair work, checks must be done to ensure the required safety level. Checks must adhere to valid national or regional work safety regulations. The correct functioning of all safety functions shall also be tested.

The purpose of maintenance and repair work is to ensure that the system is kept operational or, in the event of a fault, to return the system to an operational state. Repair work includes troubleshooting in addition to the actual repair itself.

When working on the robot arm or control box, you must observe the procedures and warnings below.

Warning



WARNING

Failure to adhere to any of the safety practices, listed below, can result in injury.

- Unplug the main power cable from the bottom of the Control Box to ensure that it is completely unpowered. Power off any other source of energy connected to the robot arm or Control Box. Take necessary precautions to prevent other persons from powering on the system during the repair period.
- Check the earth connection before re-powering the system.
- Observe ESD regulations when parts of the robot arm or Control Box are disassembled.
- Prevent water and dust from entering the robot arm or Control Box.

Warning: Electricity



WARNING: ELECTRICITY

Disassembling the Control Box power supply too quickly after switching off, can result in injury due to electrical hazards.

- Avoid disassembling the power supply inside the Control Box, as high voltages (up to 600 V) can be present inside these power supplies for several hours after the Control Box has been switched off.

6.1. Cleaning

Description

Everyday cleaning

You can wipe away any dust/dirt/oil observed on the robot arm using a cloth and one of the following cleaning agents: Water, Isopropyl alcohol, 10% Ethanol alcohol or 10% Naphtha. In rare cases, very small amounts of grease can be visible from the joint.

This does not affect the function, use, or lifetime of the joint.

Additional cleaning

Due to the added focus on cleaning your robot, UR recommends cleaning with 70% isopropyl alcohol (rubbing alcohol).

1. Wipe the robot with a hard twisted micro fiber cloth and 70% isopropyl alcohol (rubbing alcohol).
2. Let the 70% isopropyl alcohol dwell on the robot for 5 minutes, and then clean the robot using standard cleaning procedure.

DO NOT USE BLEACH. Do not use bleach in any diluted cleaning solution.

6.2. Inspection

6.2.1. Robot Arm Inspection Plan

Description

The table below is a checklist of the type of inspections recommended by Universal Robots. Perform inspections regularly, as advised in the list. Any listed parts found to be in an unacceptable state must be repaired or replaced.

You can access the Service Manual (<http://www.universal-robots.com/support>) for more on how to perform inspections.

Inspection action type			Timeframe		
			Monthly	Biannually	Annually
1	Check blue lids*	V	X		
2	Check flat rings	V		X	
3	Check robot cable	V		X	
4	Check robot cable connection	V		X	

V = Visual inspection

* = Must also be checked after heavy collision

6.2.2. Robot Arm Visual Inspection

Description



NOTICE

Using compressed air to clean the robot arm can damage the robot arm components.

- Never use compressed air to clean the robot arm.

Inspection points

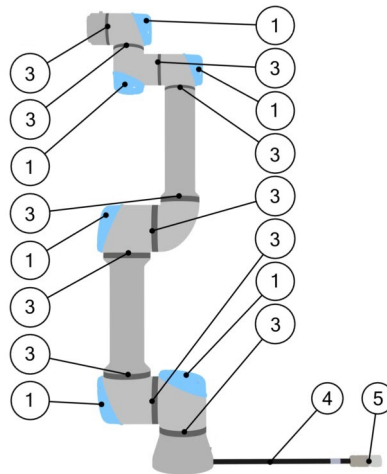

1. Move the robot arm to the Zero position, if possible.
2. Turn off the robot and disconnect the power cable from the Control Box.
3. Inspect the cable between the Control Box and robot arm for any damage.
4. Check the base mounting bolts are properly tightened.
5. Inspect the flat rings for wear and damage.
 - Replace the flat rings if they are worn or damaged.
6. Inspect the blue lids on all the joints for any cracks or damage.
 - Replace the blue lids if they are cracked or damaged.
7. Inspect the screws used to secure the blue lids.



NOTICE

If any damage is observed on a robot within the warranty period, contact the distributor where the robot was purchased.

6.2.3. Freedrive Inspection

Inspection

1. Unmount any tool/s or attachment/s or set the TCP/Payload/CoG according to tool specifications.
2. To move the robot arm in Freedrive:
 - On the 3PE Teach Pendant, rapidly light-press, then light-press-and-hold the 3PE button.

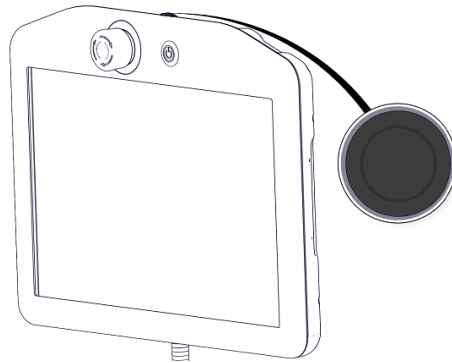

Power button

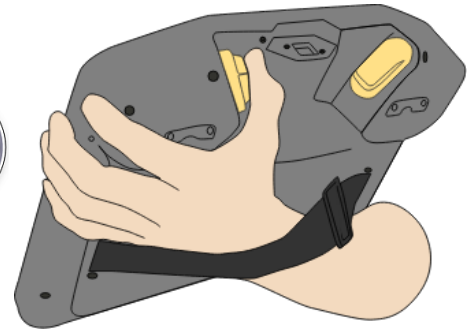

3PE button

3. Pull/Push the robot to a horizontally elongated position and release.

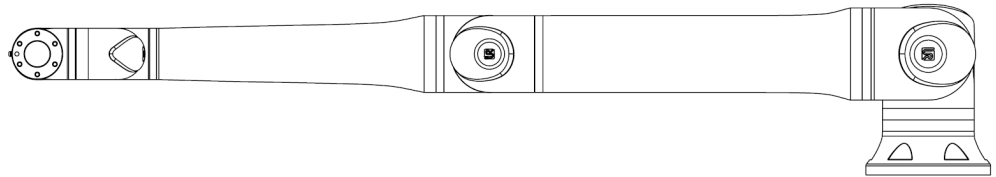

4. Verify the robot arm can maintain the position without support and without activating Freedrive.

6.2.4. Control Box Inspection Plan

Description

The table below is a checklist of the type of inspections recommended by Universal Robots. Perform inspections regularly, as advised in the list. Any listed parts found to be in an unacceptable state must be repaired or replaced.

You can access the Service Manual (<http://www.universal-robots.com/support>) for more on how to perform inspections.

Inspection action type			Timeframe		
			Monthly	Biannually	Annually
1	Check Emergency stop on Teach Pendant	F	X		
2 & 3	Check Backdrive mode	F		X	
	Check Freedrive mode	F		X	
4 & 5	Check Teach Pendant cable and connector	V		X	
6	Check and clean air filters on Control Box	V	X		

V = Visual inspection F = Functional inspection

Control Box Visual Inspection

Description

1. Disconnect the power cable from Control Box.
2. Check for any dirt/dust outside the Control Box.
 - Clean with ESD vacuum cleaner if needed.



NOTICE

Using compressed air to clean inside the Control Box can damage components.

- Do not use compressed air to clean inside the Control Box.

7. Disposal and Environment

Description

Universal Robots e-Series robots must be disposed of in accordance with the applicable national laws, regulations and standards.

Universal Robots e-Series robots are produced with restricted use of hazardous substances to protect the environment; as defined by the European RoHS directive 2011/65/EU. These substances include mercury, cadmium, lead, chromium VI, polybrominated biphenyls and polybrominated diphenyl ethers.

Fee for disposal and handling of electronic waste of Universal Robots e-Series robots sold on the Danish market is prepaid to DPA-system by Universal Robots A/S.

Importers in countries covered by the European WEEE Directive 2012/19/EU must make their own registration to the national WEEE register of their country. The fee is typically less than 1€/robot. A list of national registers can be found here:





<https://www.ewrn.org/national-registers>.

8. Certifications

Description

Third party certification is voluntary. However, to provide the best service to robot integrators, Universal Robots chooses to certify its robots at the recognized test institutes listed below.
 You can find copies of all certificates in the chapter: Certificates.

Certificates

 <p>EN ISO 10218-1 EN ISO 13849-1</p> <p>www.tuv.com ID 0007000000</p>	<p>TÜV Rheinland</p>	<p>Certificates by TÜV Rheinland to EN ISO 10218-1 and EN ISO 13849-1. TÜV Rheinland stands for safety and quality in virtually all areas of business and life. Founded 150 years ago, the company is one of the world's leading testing service providers.</p>
	<p>CHINA RoHS</p>	<p>Universal Robots e-Series robots conform to CHINA RoHS management methods for controlling pollution by electronic information products.</p>
	<p>KCC Safety</p>	<p>Universal Robots e-Series robots have been assessed and conform to KCC mark safety standards.</p>
	<p>KC Registration</p>	<p>The Universal Robots e-Series robots have been evaluated for conformity assessment for use in a work environment. Therefore, there is a risk of radio interference when used in a domestic environment.</p>
	<p>Delta</p>	<p>Universal Robots e-Series robots are performance tested by DELTA.</p>

Supplier Third Party Certification

	<p>Environment</p>	<p>As provided by our suppliers, Universal Robots e-Series robots shipping pallets comply with the ISMPM-15 Danish requirements for producing wood packaging material and are marked in accordance with this scheme.</p>
---	--------------------	--

Copyright © 2009-2024 by Universal Robots A/S. All rights reserved.

Manufacturer Test Certification

	Universal Robots	Universal Robots e-Series robots undergo continuous internal testing and end of line test procedures. UR testing processes undergo continuous review and improvement.
---	------------------	--

Declarations According to EU directives

Although EU directives are relevant for Europe, some countries outside Europe recognize and/or require EU declarations. European directives are available on the official homepage: <http://eur-lex.europa.eu>.
According to the Machinery Directive, Universal Robots' robots are partly completed machines, as such a CE mark is not to be affixed.
You can find the Declaration of Incorporation (DOI) according to the Machinery Directive in the chapter: Declarations and Certificates.

Copyright © 2009-2024 by Universal Robots A/S. All rights reserved.

9. Stopping Time and Stopping Distance

Description

You can set user-defined safety rated maximum stopping time and distance. See [Description on page 28](#) and [Safety](#).

If user-defined settings are used, the program speed is dynamically adjusted to always comply with the selected limits.

The payload CoG is at the tool flange.

The graphical data provided for **Joint 0 (base)**, **Joint 1 (shoulder)** and **Joint 2 (elbow)** is valid for stopping distance and stopping time:

- Category 0
- Category 1
- Category 2

The **Joint 0** test was carried out by performing a horizontal movement, where the rotational axis was perpendicular to the ground.

During the **Joint 1** and **Joint 2** tests, the robot followed a vertical trajectory, where the rotational axes were parallel to the ground, and the stop was performed while the robot was moving downward. The Y-axis is the distance from where the stop is initiated to the final position.

Joint 0 (BASE)

Stopping distance in meters for 33% of 3kg

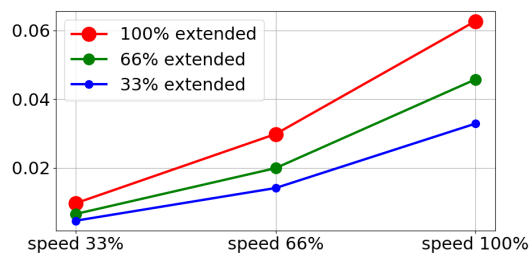

Stopping distance in meters for 66% of 3kg

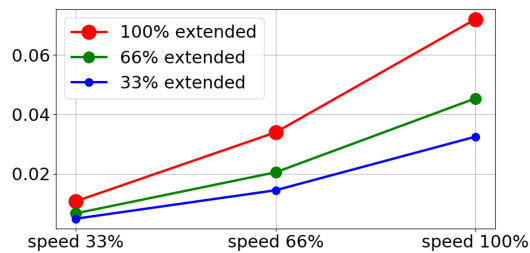

Stopping distance in meters for maximum payload of 3kg

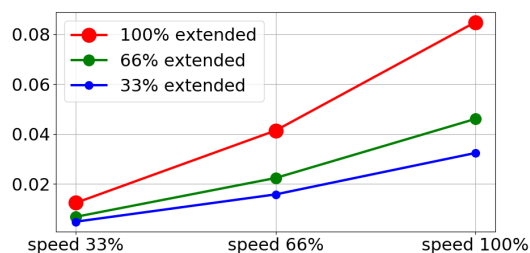

Joint 0 (BASE)

Stopping time in seconds for 33% of 3kg

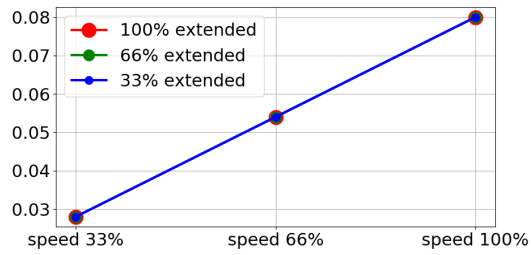

Stopping time in seconds for 66% of 3kg

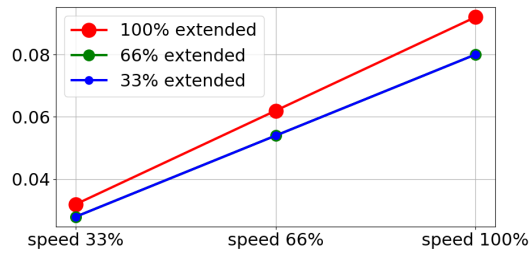

Stopping time in seconds for maximum payload of 3kg

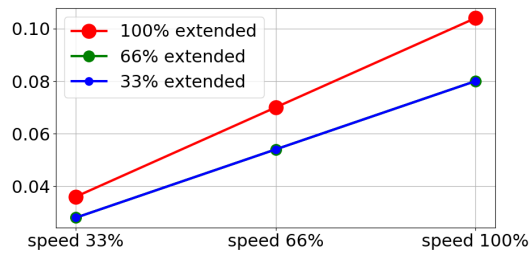

Joint 1 (SHOULDER)

Stopping distance in meters for 33% of 3kg

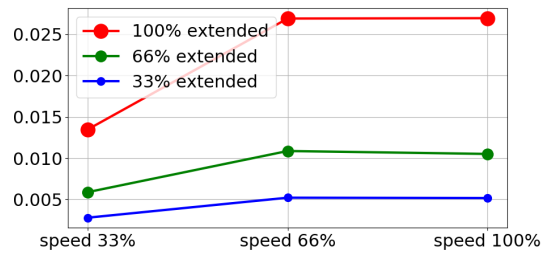

Stopping distance in meters for 66% of 3kg

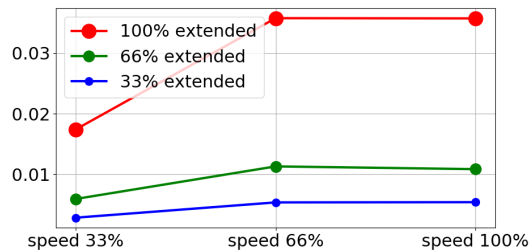

Stopping distance in meters for maximum payload of 3kg

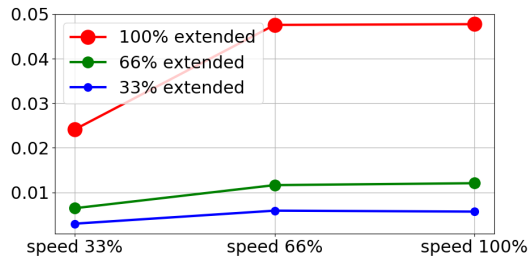

Joint 1 (SHOULDER)

Stopping time in seconds for 33% of 3kg

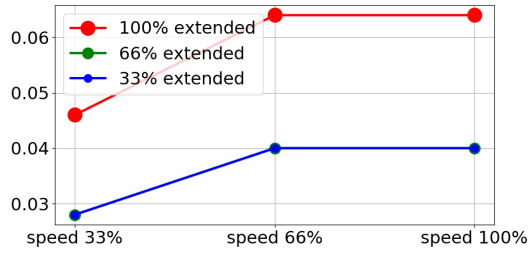

Stopping time in seconds for 66% of 3kg

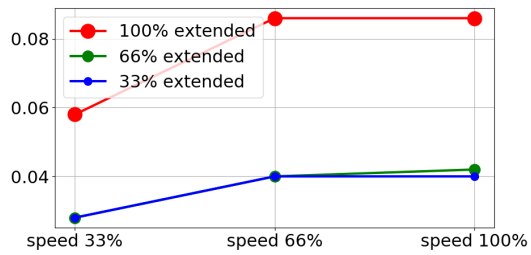

Stopping time in seconds for maximum payload of 3kg

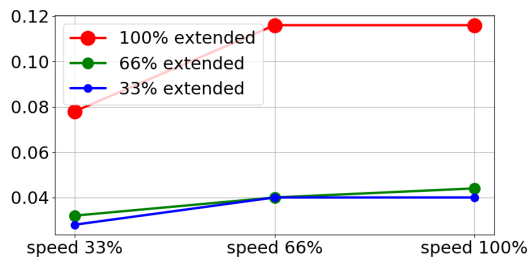

Joint 2 (ELBOW)

Stopping distance in meters for all payloads

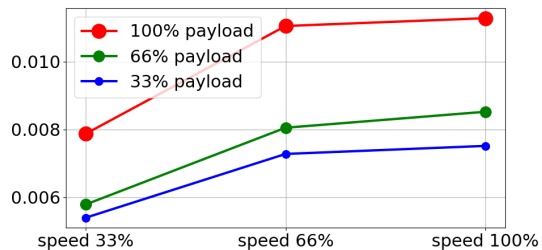

Stopping time in seconds for all payloads

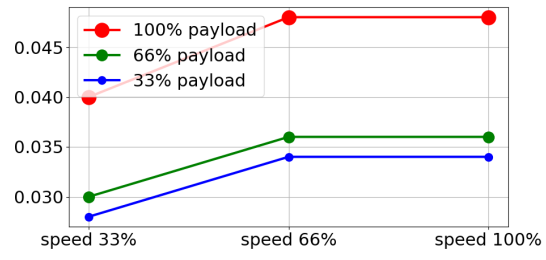

10. Declarations and Certificates (original EN)

EU Declaration of Incorporation (DOI) (in accordance with 2006/42/EC Annex II B) original EN	
Manufacturer	Universal Robots A/S Energivej 25, DK-5260 Odense S Denmark
Person in the Community Authorized to Compile the Technical File	David Brandt Technology Officer, R&D Universal Robots A/S, Energivej 25, DK-5260 Odense S
Description and Identification of the Partially-Completed Machine(s)	
Product and Function:	Industrial robot multi-purpose multi-axis manipulator with control box & with or without teach pendant Function is determined by the completed machine (robot application or cell with end-effector, intended use and application program).
Model :	UR3e, UR5e, UR10e, UR16e (e-Series): Below cited certifications and this declaration include: <ul style="list-style-type: none"> • Effective October 2020: Teach Pendants with 3-Position Enabling (3PE TP) & standard Teach Pendants (TP). • Effective May 2021: UR10e specification improvement to 12.5kg maximum payload.
	Note: This Declaration of Incorporation is NOT applicable when the UR OEM Controller is used.
Serial Number:	Starting 20235000000 and higher year e-Series 3=UR3e, 5=UR5e, 3=UR3e, 0=UR10e (10kg), 2=UR10e(12.5), 6=UR16e sequential numbering, restarting at 0 each year
Incorporation:	Universal Robots e-Series (UR3e, UR5e, UR10e and UR16e) shall only be put into service upon being integrated into a final complete machine (robot application or cell), which conforms with the provisions of the Machinery Directive and other applicable Directives.
It is declared that the above products fulfil, for what is supplied, the following directives as detailed below: When this incomplete machine is integrated and becomes a complete machine, the integrator is responsible for determining that completed machine fulfils all applicable Directives and providing the Declaration of Conformity.	
I. Machinery Directive 2006/42/EC	The following essential requirements have been fulfilled: 1.1.2, 1.1.3, 1.1.5, 1.2.1, 1.2.4.3, 1.2.5, 1.2.6, 1.3.2, 1.3.4, 1.3.8.1, 1.3.9, 1.5.1, 1.5.2, 1.5.5, 1.5.6, 1.5.10, 1.6.3, 1.7.2, 1.7.4, 4.1.2.3, 4.1.3, Annex VI. It is declared that the relevant technical documentation has been compiled in accordance with Part B of Annex VII of the Machinery Directive.
II. Low-voltage Directive 2014/35/EU	Reference the LVD and the harmonized standards used below.
III. EMC Directive 2014/30/EU	Reference the EMC Directive and the harmonized standards used below.



Reference to the harmonized standards used, as referred to in Article 7(2) of the MD & LV Directives and Article 6 of the EMC Directive:

(I) EN ISO 10218-1:2011 TÜV Nord Certificate # 44 708 14097607	(I) (II) EN 60204-1:2018 as applicable (II) EN 60529:1991+A1:2000+A2:2013 (I) EN 60947-5-5:1997+A1:2005 +A11:2013+A2:2017 (I) EN 60947-5-8:2020 (III) EN 61000-3-2:2019	(II) EN 60664-1:2007 (III) EN 61000-3-3: 2013 (III) EN 61000-6-1:2019 UR3e & UR5e ONLY (III) EN 61000-6-2:2019 (III) EN 61000-6-3:2007+A1: 2011 UR3e & UR5e ONLY (III) EN 61000-6-4:2019
--	---	--

Reference to other technical standards and technical specifications used:

(I) ISO 9409-1:2004 [Type 50-4-M6] (I) ISO/TS 15066:2016 as applicable (III) EN 60068-2-1: 2007 (III) EN 60068-2-2:2007	(II) EN 60320-1:2021 (III) EN 60068-2-27:2008 (III) EN 60068-2-64:2008+A1:2019	(II) EN 61784-3:2010 [SIL2] (III) EN 61326-3-1: 2017 [Industrial locations SIL 2]
---	--	---

The manufacturer, or his authorised representative, shall transmit relevant information about the partly completed machinery in response to a reasoned request by the national authorities. Approval of full quality assurance system (ISO 9001), by the notified body Bureau Veritas, certificate #DK015892.

Odense Denmark, 10 January 2024

Roberta Nelson Shea, Global Technical Compliance Officer

11. Warranty Information

Product Warranty Direct your warranty inquiries to product related information on [myUR](#)

**User Manual
Disclaimer**

Universal Robots A/S continues to improve the reliability and performance of its products, and as such reserves the right to upgrade products, and product documentation, without prior warning. Universal Robots A/S takes every care to ensure the contents of the User Manual/s are precise and correct, but takes no responsibility for any errors or missing information.

12. Certificates

TÜV Rheinland

Page 1

Certificate

Certificate no. **T 72404326 0001**

License Holder: Universal Robots A/S Energivej 25 5260 Odense S Denmark	Manufacturing Plant: Universal Robots A/S Energivej 25 5260 Odense S Denmark
Report Number: 31875333 004	Client Reference: Roberta Nelson Shea
Certification acc. to: EN ISO 10218-1:2011 EN ISO 13849-1:2015	

Product Information

Certified Product:	Industrial Robot
Model Designation:	UR3, UR5, UR10, UR3e, UR5e, UR10e, UR16e, UR20, UR30
Technical Data:	Rated Voltage: AC 100-200V, 50/60Hz or AC 200-240V, 50/60Hz Rated Current: 15A or 8A Protection Class: I
Remarks:	Solely assessed per standards listed above. The robot is only a component in a final robot application, collaborative or non-collaborative. The final application/installation must comply with EN ISO 10218-2 accordingly. Replaces Certificate T72190266.
Appendix:	1, 1-68



Date of issue: 2024-02-27
(yr/mo/day)

Copyright © 2009-2024 by Universal Robots A/S. All rights reserved.

© TÜV, TÜV and TÜV are registered trademarks. Utilization and application requires prior approval.

TUV Rheinland of North America, Inc.
400 Beaver Brook Rd, Boxborough, MA 01719
Tel +1 (978) 266 9500, Fax +1 (978) 266-9992

www.tuv.com



China RoHS

**Management Methods for Controlling Pollution
by Electronic Information Products
Product Declaration Table For Toxic or Hazardous Substances**

表1 有毒有害物质或元素名称及含量标识格式



Product/Part Name 产品/部件名称	Toxic and Hazardous Substances and Elements 有毒有害物质或元素					
	铅 Lead (Pb)	汞 Mercury (Hg)	镉 Cadmium (Cd)	六价 Hexavalent Chromium (Cr+6)	多溴联苯 Polybrominated biphenyls (PBB)	多溴二苯醚 Polybrominated diphenyl ethers (PBDE)
UR Robots 机器人：基本系统 UR3 / UR5 / UR10 / UR3e / UR5e / UR10e UR16e / UR20 / UR30	X	O	X	O	X	X

O: Indicates that this toxic or hazardous substance contained in all of the homogeneous materials for this part is below the limit requirement in SJ/T11363-2006.
 O: 表示该有毒有害物质在该部件所有均质材料中的含量均在SJ/T 11363-2006规定的限量要求以下。
 X: Indicates that this toxic or hazardous substance contained in at least one of the homogeneous materials used for this part is above the limit requirement in SJ/T11363-2006.
 X: 表示该有毒有害物质至少在该部件的某一均质材料中的含量超出SJ/T 11363-2006规定的限量要求。
 (企业可在此处·根据实际情况对上表中打“X”的技术原因进行进一步说明。)
 Items below are wear-out items and therefore can have useful lives less than environmental use period:
 下列项目是损耗品,因而它们的有用环境寿命可能短于基本系统和可选项目的使用时间:
 Drives, Gaskets, Probes, Filters, Pins, Cables, Stiffener, Interfaces
 电子驱动器, 垫圈, 探针, 过滤器, 别针, 缆绳, 加强筋, 接口
 Refer to product manual for detailed conditions of use.
 详细使用情况请阅读产品手册。
 Universal Robots encourages that all Electronic Information Products be recycled but does not assume responsibility or liability.
 Universal Robots 鼓励回收再利用所有的电子信息产品,但 Universal Robots 不负任何责任或义务

To the maximum extent permitted by law, Customer shall be solely responsible for complying with, and shall otherwise assume all liabilities that may be imposed in connection with, any legal requirements adopted by any governmental authority related to the Management Methods for Controlling Pollution by Electronic Information Products (Ministry of Information Industry Order #39) of the Peoples Republic of China otherwise encouraging the recycle and use of electronic information products. Customer shall defend, indemnify and hold Universal Robots harmless from any damage, claim or liability relating thereto. At the time Customer desires to dispose of the Products, Customer shall refer to and comply with the specific waste management instructions and options set forth at www.universal-robots.com/about-universal-robots/social-responsibility and www.teradyne.com/company/corporate-social-responsibility, as the same may be amended by Teradyne or Universal Robots.

Copyright © 2009-2024 by Universal Robots A/S. All rights reserved.

KC Safety



자율안전확인 신고증명서

신청인	사업장명	Universal Robots A/S	사업장관리번호	2016E110079
	사업자등록번호	016E110079	대표자 성명	Klaus Vestergaard
	소재지	Energivej 25, 5260 Odense S, Denmark		
자율안전인증대상 기계·기구명		산업용로봇		
형식(규격)	UR3e	용량(등급)	6 axis	
자율안전확인번호	18-AB2EQ-01604			
제조사	Universal Robots A/S			
소재지	Energivej 25, 5260 Odense S, Denmark			

「산업안전보건법」 제35조제1항 및 같은 법 시행규칙 제61조제3항에 따라 자율안전확인 신고증명서를 발급합니다.

2018년 11월 06일

한국산업안전보건공단 서울지역본부장

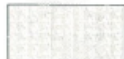

KC Registration

EFAE-5467-CA8B-0E3C

방송통신기자재등의 적합등록 필증 Registration of Broadcasting and Communication Equipments	
상호 또는 성명 <i>Trade Name or Registrant</i>	Universal Robots A/S
기자재명칭(제품명칭) <i>Equipment Name</i>	UR e-Series robot
기본모델명 <i>Basic Model Number</i>	UR3e
파생모델명 <i>Series Model Number</i>	
등록번호 <i>Registration No.</i>	R-R-URK-UR3e
제조사/제조(조립)국가 <i>Manufacturer/Country of Origin</i>	Universal Robots A/S / 덴마크
등록연월일 <i>Date of Registration</i>	2018-10-23
기타 <i>Others</i>	
위 기자재는 「전파법」 제58조의2 제3항에 따라 등록되었음을 증명합니다. It is verified that foregoing equipment has been registered under the Clause 3, Article 58-2 of Radio Waves Act.	
2018년(Year) 10월(Month) 23일(Day)	
 국립전파연구원장 Director General of National Radio Research Agency	
※ 적합등록 방송통신기자재는 반드시 "적합성평가표시" 를 부착하여 유통하여야 합니다. 위반시 과태료 처분 및 등록이 취소될 수 있습니다.	



Copyright © 2009-2024 by Universal Robots A/S. All rights reserved.

Environment

Climatic and mechanical assessment



Client Universal Robots A/S Energivej 25 5260 Odense S Denmark	Force Technology project no. 117-32120
Product identification UR 3 robot arms UR 3 control boxes with attached Teach Pendants. UR 5 robot arms UR5 control boxes with attached Teach Pendants. UR10 robot arms: UR10 control boxes with attached Teach Pendants. See reports for details.	
Force Technology report(s) DELTA project no. 117-28266, DANAK-19/18069 DELTA project no. 117-28086, DANAK-19/17068	
Other document(s)	
Conclusion The three robot arms UR3, UR5 and UR10 including their control boxes and Teach Pendants have been tested according to the below listed standards. The test results are given in the Force Technology reports listed above. The tests were carried out as specified and the test criteria for environmental tests were fulfilled in general terms with only a few minor issues (see test reports for details). IEC 60068-2-1, Test Ae; -5 °C, 16 h IEC 60068-2-2, Test Be; +35°C, 16h IEC 60068-2-2, Test Be; +50°C, 16 h IEC 60068-2-64, Test Fh; 5 – 10 Hz: +12 dB/octave, 10-50 Hz 0.00042 g ² /Hz, 50 – 100 Hz: -12 dB/octave, 1,66 grms, 3 x 1½ h IEC 60068-2-27, Test Ea, Shock; 11 g, 11 ms, 3 x 18 shocks	
Date Hørsholm, 25 August 2017	Assessor  Andreas Wendelboe Højsgaard M.Sc.Eng.

DELTA – a part of FORCE Technology - Venlighedsvej 4 - 2970 Hørsholm - Denmark - Tel. +45 72 19 40 00 - Fax +45 72 19 40 01 - www.delta.dk

Copyright © 2009-2024 by Universal Robots A/S. All rights reserved.

13. Applied Standards

Description

This section describes relevant standards applied to the development and manufacturing of the UR robot, including the robot arm, Control Box and Teach Pendant .

A standard is not a law, but a document developed by stakeholders within a given industry. Standards contain requirements and guidance for a product or product group. The abbreviations in this manual and their meaning are listed in the table below:

Abbreviations in this document	
ISO	International Organization for Standardization
IEC	International Electrotechnical Commission
EN	European Norm
TS	Technical Specification
TR	Technical Report
ANSI	American National Standards Institute
RIA	Robotic Industries Association (now known as “A3”)
CSA	Canadian Standards Association

Applied Standards

Maintaining robot compliance with the following standards requires adhering to the assembly instructions, safety instructions and guidance in this manual. For the safety of the robot application, the integrator is required to comply with ISO 10218-2. Unauthorized modifications invalidate the Declaration of Incorporation (DOI), certifications and conformity of the robot.

UR robots comply with the relevant requirements in the applied standards. Applicable test reports and certifications included in this manual and the standards are listed in the Declaration of Incorporation.

The standards applicable to this manual are listed in the table below:

**ISO 13849-1
ISO 13849-2**

Clause	Description
Safety of machinery - Safety related parts of control systems Part 1: General principles for design Part 2: Validation	The safety control system is designed according to the requirements of these standards. The Safety Functions are certified to these functional safety standards.

ISO 13850

Clause	Description
Safety of machinery - Emergency stop - Principles for design	---

ISO 12100

Clause	Description
Safety of machinery - General principles for design - Risk assessment and risk reduction	---



ISO 10218-1

Clause	Description
Robots and robotic devices - Safety requirements for industrial robots Part 1: Robots	This standard is intended for the robot manufacturer, not the integrator. ISO 10218-2 has the safety requirements associated with the robot system, application and cell. It deals with the design and integration of the robot application.

ANSI/RIA R15.06

Clause	Description
Industrial Robots and Robot Systems - Safety Requirements	This American national standard is a national adoption without deviation of both ISO 10218-1 and ISO 10218-2, combined into one document. The language is changed from British International English to American English, but the technical contents are the same. Part 2 of this standard is intended for the integrator of the robot system / robot application, and not Universal Robots.

CAN/CSA-Z434

Clause	Description
Industrial Robots and Robot Systems - General Safety Requirements	This Canadian national standard is a national adoption of both ISO 10218-1 and ISO 10218-2 combined into one document. CSA added User to clauses within Part 2. Part 2 of this standard is intended for the integrator of the robot system/ robot application, and not Universal Robots.

CAN/CSA-Z434

Clause	Description
Industrial Robots and Robot Systems - General Safety Requirements	This Canadian national standard is a national adoption of both ISO 10218-1 and ISO 10218-2 combined into one document. CSA added User to clauses within Part 2. Part 2 of this standard is intended for the integrator of the robot system/ robot application, and not Universal Robots.

IEC 61000-6-2
IEC 61000-6-4

Clause	Description
Electromagnetic compatibility (EMC) Part 6-2: Generic standards - Immunity for industrial environments Part 6-4: Generic standards - Emission standard for industrial environments	These standards define requirements for the electrical and electromagnetic disturbances. Conforming to these standards ensures that the UR robots perform well in industrial environments and that they do not disturb other equipment.

IEC 61326-3-1

Clause	Description
Electrical equipment for measurement, control and laboratory use - EMC requirements Part 3-1: Immunity requirements for safety-related systems and for equipment intended to perform safety-related functions (functional safety) - General industrial applications	This standard defines extended EMC immunity requirements for safety-related functions. Conforming to this standard ensures that the safety functions perform even if other equipment exceeds the EMC emission limits defined in the IEC 61000 standards.

IEC 61131-2	Clause	Description
	Programmable controllers Part 2: Equipment requirements and tests	Both standard and safety-rated 24V I/Os comply with the requirements of this standard to ensure reliable communication with other PLC systems.
IEC 14118	Clause	Description
	Safety of machinery - Prevention of unexpected startup	Safety requirements to prevent an unexpected start and re-start, as a result of power loss or interruption of power.
IEC 60204-1	Clause	Description
	Safety of machinery - Electrical equipment of machines Part 1: General requirements	The emergency stop function is designed as a Stop Category 1 according to this standard. Stop Category 1 is a controlled stop with power to the motors to achieve the stop and then removal of power when the stop is achieved.
IEC 60947-5-5	Clause	Description
	Low-voltage switchgear and controlgear Part 5-5: Control circuit devices and switching elements - Electrical emergency stop device with mechanical latching function	---
IEC 60529	Clause	Description
	Degrees of protection provided by enclosures (IP Code)	This standard defines enclosure ratings regarding protection against dust and water.
IEC 60320-1	Clause	Description
	Appliance couplers for household and similar general purposes Part 1: General requirements	The mains input cable complies with this standard.
ISO 9409-1	Clause	Description
	Manipulating industrial robots - Mechanical interfaces Part 1: Plates	The tool flange on UR robots conforms to a type according to this standard. Robot tools (end-effectors) should also be constructed according to the same type to ensure proper fitting to the mechanical interface of the specific UR robot.
ISO 13732-1	Clause	Description
	Ergonomics of the thermal environment - Methods for the assessment of human responses to contact with surfaces Part 1: Hot surfaces	---

IEC 61140	Clause	Description
	Protection against electric shock - Common aspects for installation and equipment	A protective earth/ground connection is mandatory, as defined in the Part I Hardware Installation Manual.
IEC 60068-2-1 IEC 60068-2-2 IEC 60068-2-27 IEC 60068-2-64	Clause	Description
	Environmental testing Part 2-1: Tests - Test A: Cold Part 2-2: Tests - Test B: Dry heat Part 2-27: Tests - Test Ea and guidance: Shock Part 2-64: Tests - Test Fh: Vibration, broadband random and guidance	---
IEC -61784-3	Clause	Description
	Industrial communication networks - Profiles Part 3: Functional safety fieldbuses - General rules and profile definitions	---
IEC 61784-3	Clause	Description
	Safety of machinery - Electrical equipment of machines Part 1: General requirements	---
IEC 60664-1 IEC 60664-5	Clause	Description
	Insulation coordination for equipment within low-voltage systems Part 1: Principles, requirements and tests Part 5: Comprehensive method for determining clearances and creepage distances equal to or less than 2 mm	---
EUROMAP 67:2015, V1.11	Clause	Description
	Electrical Interface between Injection Molding Machine and Handling Device / Robot	The E67 accessory module, that interfaces with injection molding machines, complies with this standard.

14. Technical Specifications

Robot type	UR3e
Robot weight	11.1 kg / 24.5 lb
Maximum payload	3 kg / 6.6 lb
Reach	500 mm / 19.7 in
Joint ranges	Unlimited rotation of tool flange, $\pm 360^\circ$ for all other joints
Speed	All wrist joints: Max 360 °/s. Other joints: Max 180 °/s . Tool: Approx. 1 m/s / Approx. 39.4 in/s.
System update frequency	500 Hz
Force Torque sensor accuracy	3.5 N
Pose repeatability	± 0.03 mm / ± 0.0011 in (1.1 mils)per ISO 9283
Footprint	$\varnothing 128$ mm / 5.0 in
Degrees of freedom	6 rotating joints
Control Box size (W × H × D)	460 mm × 449 mm × 254 mm / 18.2 in × 17.6 in × 10 in
Control Box I/O ports	16 digital in, 16 digital out, 2 analog in, 2 analog out
Tool I/O ports	2 digital in, 2 digital out, 2 analog in
Tool Communication	RS
Tool I/O power supply & voltage	12 V/24 V 600 mA
Control Box I/O power supply	24 V 2 A in Control Box
Communication	TCP/IP 1000 Mbit: IEEE 802.3ab, 1000BASE-T Ethernet socket, MODBUS TCP & EtherNet/IP Adapter, Profinet
Programming	PolyScope graphical user interface on 12" touchscreen
Noise	Robot Arm: Less than 60dB(A) Control Box: Less than 50dB(A) Robot Arm: Less than 65dB(A) Control Box: Less than 50dB(A)
IP classification	IP54
Cleanroom classification (overall for model)	Robot Arm: ISO Class 7, Control Box: ISO Class 6
Power consumption (average)	300 W
Power consumption	Approx. 150 W using a typical program
Short-Circuit Current Rating (SCCR)	200A
Collaboration operation	17 advanced safety functions. In compliance with: EN ISO 13849-1, PLd, Cat.3 and EN ISO 10218-1
Materials	Aluminium, PC/ASA plastic
Ambient temperature range	The robot can work in an ambient temperature range of 0-50 °C At high continuous joint speed, the maximum ambient temperature specification is derated.
Control Box power source	100-240 VAC, 47-440 Hz
TP cable: Teach Pendant to Control Box	4.5 m / 177 in
Robot Cable: Robot Arm to Control Box (options)	Standard (PVC) 6 m/236 in x 13.4 mm Standard (PVC) 12 m/472.4 in x 13.4 mm HiFlex (PUR) 6 m/236 in x 12.1 mm HiFlex (PUR) 12 m/472.4 in x 12.1 mm

15. Safety Functions Table 1

Description

Universal Robots safety functions and safety I/O are PLd Category 3 (ISO 13849-1), where each safety function has a PFH_D value less than 1.8E-07. The PFH_D values are updated to include greater design flexibility for supply chain resilience. For Safety Function (SF) Descriptions see: [15 Safety Functions Table 1 above](#). For safety I/O the resulting safety function including the external device, or equipment, is determined by the overall architecture and the sum of all PFH_Ds, including the UR robot safety function PFH_D.



NOTICE

The Safety Functions tables presented in this chapter are simplified. You can find the comprehensive versions of them here: <https://www.universal-robots.com/support>

SF# and Safety Function

SF1 Emergency Stop (according to ISO 13850)

See footnotes

Description	What happens?	Tolerance and PFH _D	Affects
<p>Pressing the Estop PB on the pendant¹ or the External Estop (if using the Estop Safety Input) results in a Stop Cat 1³ with power removed from the robot actuators and the tool I/O. Command¹ all joints to stop and upon all joints coming to a monitored standstill state, power is removed.</p> <p>For the integrated functional safety rating with an external safety-related control system or an external emergency stop device that is connected to the Emergency Stop input, add the PFH_D of this safety-related input to the PFH_D of this safety function's PFH_D value (less than 1.8E-07).</p>	<p>Category 1 stop (IEC 60204-1)</p>	<p>Tol: -- PFH_D: 1.8E-07</p>	<p>Robot including robot tool I/O</p>

SF2 Safeguard Stop 4 (Robot Stop according to ISO 10218-1)

Description	What happens?	Tolerance and PFH _D	Affects
This safety function is initiated by an external protective device using safety inputs that initiate a Cat 2 stop ³ . The tool I/O are unaffected by the safeguard stop. Various configurations are provided. If an enabling device is connected, it's possible to configure the safeguard stop to function in automatic mode ONLY. See the Stop Time and Stop Distance Safety Functions ⁴ . For the functional safety of the complete integrated safety function, add the PFHd of the external protective device to the PFHd of the Safeguard Stop.	Category 2 stop (IEC 60204-1) SS2 stop (as described in IEC 61800-5-2)	Tol: -- PFH _D : 1.8E-07	Robot

SF3 Joint Position Limit (soft axis limiting)

Description	What happens?	Tolerance and PFH _D	Affects
Sets upper and lower limits for the allowed joint positions. Stopping time and distance is not a considered as the limit(s) will not be violated. Each joint can have its own limits. Directly limits the set of allowed joint positions that the joints can move within. It is set in the safety part of the User Interface. It is a means of safety-rated soft axis limiting and space limiting, according to ISO 10218-1:2011, 5.12.3.	Will not allow motion to exceed any limit settings. Speed could be reduced so motion will not exceed any limit. A robot stop will be initiated to prevent exceeding any limit.	Tol: 5° PFH _D : 1.8E-07	Joint (each)

SF4 Joint Speed Limit

Description	What happens?	Tolerance and PFH _D	Affects
Sets an upper limit for the joint speed. Each joint can have its own limit. This safety function has the most influence on energy transfer upon contact (clamping or transient). Directly limits the set of allowed joint speeds which the joints are allowed to perform. It is set in the safety setup part of the User Interface. Used to limit fast joint movements, e.g. risks related to singularities.	Will not allow motion to exceed any limit settings. Speed could be reduced so motion will not exceed any limit. A robot stop will be initiated to prevent exceeding any limit.	Tol: 1.15 °/s PFH _D : 1.8E-07	Joint (each)

Joint Torque Limit

Exceeding the internal joint torque limit (each joint) results in a Cat 0³. This is not accessible to the user; it is a factory setting. It is NOT shown as an e-Series safety function because there are no user settings and no user configurations.

SF5 Called various names: Pose Limit, Tool Limit, Orientation Limit, Safety Planes, Safety Boundaries

Description	What happens?	Tolerance and PFH _D	Affects
Monitors the TCP Pose (position and orientation) and will prevent exceeding a safety plane or TCP Pose Limit. Multiple pose limits are possible (tool flange, elbow, and up to 2 configurable tool offset points with a radius) Orientation restricted by the deviation from the feature Z direction of the tool flange OR the TCP. This safety function consists of two parts. One is the safety planes for limiting the possible TCP positions. The second is the TCP orientation limit, which is entered as an allowed direction and a tolerance. This provides TCP and wrist inclusion/ exclusion zones due to the safety planes.	Will not allow motion to exceed any limit settings. Speed or torques could be reduced so motion will not exceed any limit. A robot stop will be initiated to prevent exceeding any limit. Will not allow motion to exceed any limit settings.	Tol: 3° 40 mm PFH _D : 1.8E-07	TCP Tool flange Elbow

SF6 Speed Limit TCP & Elbow

Description	What happens?	Tolerance and PFH _D	Affects
Monitors the TCP and elbow speed to prevent exceeding a speed limit.	Will not allow motion to exceed any limit settings. Speed or torques could be reduced so motion will not exceed any limit. A robot stop will be initiated to prevent exceeding any limit. Will not allow motion to exceed any limit settings.	Tol:50 mm/s PFH _D : 1.8E-07	TCP

SF7 Force Limit (TCP)

Description	What happens?	Tolerance and PFH _D	Affects
The Force Limit is the force exerted by the robot at the TCP (tool center point) and “elbow”. The safety function continuously calculates the torques allowed for each joint to stay within the defined force limit for both the TCP & the elbow. The joints control their torque output to stay within the allowed torque range. This means that the forces at the TCP or elbow will stay within the defined force limit. When a monitored stop is initiated by the Force Limit SF, the robot will stop, then “back-off” to a position where the force limit was not exceeded. Then it will stop again.	Will not allow motion to exceed any limit settings. Speed or torques could be reduced so motion will not exceed any limit. A robot stop will be initiated to prevent exceeding any limit. Will not allow motion to exceed any limit settings.	Tol: 25N PFH _D : 1.8E-07	TCP

SF8 Momentum Limit

Description	What happens?	Tolerance and PFH _D	Affects
The momentum limit is very useful for limiting transient impacts. The Momentum Limit affects the entire robot.	Will not allow motion to exceed any limit settings. Speed or torques could be reduced so motion will not exceed any limit. A robot stop will be initiated to prevent exceeding any limit. Will not allow motion to exceed any limit settings.	Tol: 3kg m/s PFH _D : 1.8E-07	Robot

SF9 Power Limit

Description	What happens?	Tolerance and PFH _D	Affects
This function monitors the mechanical work (sum of joint torques times joint angular speeds) performed by the robot, which also affects the current to the robot arm as well as the robot speed. This safety function dynamically limits the current/ torque but maintains the speed.	Dynamic limiting of the current/torque	Tol: 10W PFH _D : 1.8E-07	Robot



SF10 UR Robot Estop Output

Description	What Happens	PFH _D	Affects
<p>When configured for a Robot <Estop> output and there is a robot stop, the dual outputs are LOW. If there is no Robot <Estop> Stop initiated, dual outputs are high. Pulses are not used but they are tolerated.</p> <p>These dual outputs change state for any external Estop that is connected to configurable safety inputs where this input is configured as an Emergency Stop input. For the integrated functional safety rating with an external safety-related control system, add the PFHD of this safety-related output to the PFHD of the external safety-related control system.</p> <p>For the Estop Output, validation is performed at the external equipment, as the UR output is an input to this external Estop safety function for external equipment.</p> <p>NOTE: If the IMMI (Injection Moulding Machine Interface) is used, the UR Robot Estop output is NOT connected to the IMMI. There is no Estop output signal sent from the UR robot to the IMMI. This is a feature to prevent an unrecoverable stop condition.</p>	<p>Dual outputs go low in event of an Estop if configurable outputs are set</p>	<p>1.8E-07</p>	<p>External connection to logic and/or equipment</p>

SF11 UR Robot Moving: Digital Output

Description	What Happens	PFH _D	Affects
<p>Whenever the robot is moving (motion underway), the dual digital outputs are LOW. Outputs are HIGH when no movement. The functional safety rating is for what is within the UR robot. The integrated functional safety performance requires adding this PFHd to the PFHd of the external logic (if any) and its components.</p>	<p>If configurable outputs are set:</p> <ul style="list-style-type: none"> • When the robot is moving (motion underway), the dual digital outputs are LOW. • Outputs are HIGH when no movement. 	<p>1.8E-07</p>	<p>External connection to logic and/or equipment</p>

**SF12 UR Robot
Not stopping:
Digital Output**

Description	PFH _D	Affects
When the robot is STOPPING (in process of stopping or in a stand-still condition) the dual digital outputs are HIGH. When outputs are LOW, robot is NOT in the process or stopping and NOT in a stand-still condition. The functional safety rating is for what is within the UR robot. The integrated functional safety performance requires adding this PFHd to the PFHd of the external logic (if any) and its components.	1.8E-07	External connection to logic and/or equipment

**SF13 UR Robot
Reduced Mode:
Digital Output**

Description	PFH _D	Affects
When the robot is in reduced mode (or reduced mode is initiated), the dual digital outputs are LOW. See below. The functional safety rating is for what is within the UR robot. The integrated functional safety performance requires adding this PFHd to the PFHd of the external logic (if any) and its components.	1.8E-07	External connection to logic and/or equipment

**SF14 UR Robot
Not Reduced
Mode: Digital
Output**

Description	PFH _D	Affects
Whenever the robot is NOT in reduced mode (or the reduced mode is not initiated), the dual digital outputs are LOW. The functional safety rating is for what is within the UR robot. The integrated functional safety performance requires adding this PFHd to the PFHd of the external logic (if any) and its components.	1.8E-07	External connection to logic and/or equipment

SF15 Stopping Time Limit

Description	What happens?	Tolerances and PFH _D :	Affects
<p>Real time monitoring of conditions such that the stopping time limit will not be exceeded. Robot speed is limited to ensure that the stop time limit is not exceeded.</p> <p>The stopping capability of the robot in the given motion(s) is continuously monitored to prevent motions that would exceed the stopping limit. If the time needed to stop the robot is at risk of exceeding the time limit, the speed of motion is reduced to ensure the limit is not exceeded. A robot stop will be initiated to prevent exceeding the limit. The safety function performs the same calculation of the stopping time for the given motion(s) and initiates a cat 0 stop if the stopping time limit will be or is exceeded.</p>	<p>Will not allow the actual stopping time to exceed the limit setting. Causes decrease in speed or a robot stop so as NOT to exceed the limit</p>	<p>TOL: 50 ms PFH_D: 1.8E-07</p>	<p>Robot</p>

SF16 Stopping Distance Limit

Description	What happens?	Tolerances and PFH _D :	Affects
<p>Real time monitoring of conditions such that the stopping distance limit will not be exceeded. Robot speed is limited to ensure that the stop distance limit will not be exceeded.</p> <p>The stopping capability of the robot in the given motion(s) is continuously monitored to prevent motions that would exceed the stopping limit. If the time needed to stop the robot is at risk of exceeding the time limit, the speed of motion is reduced to ensure the limit is not exceeded. A robot stop will be initiated to prevent exceeding the limit. The safety function performs the same calculation of the stopping distance for the given motion(s) and initiates a cat 0 stop if stopping time limit will be or is exceeded.</p>	<p>Will not allow the actual stopping time to exceed the limit setting. Causes decrease in speed or a robot stop so as NOT to exceed the limit</p>	<p>TOL: 40 mm PFH_D: 1.8E-07</p>	<p>Robot</p>

SF17 Safe Home Position "monitored position"

Description	What happens?	Tolerances and PFH _D :	Affects
Safety function which monitors a safety rated output, such that it ensures that the output can only be activated when the robot is in the configured and monitored "safe home position". A stop cat 0 is initiated if the output is activated when the robot is not in the configured position.	The "safe home output" can only be activated when the robot is in the configured "safe home position"	TOL: 1.7 ° PFH _D : 1.8E-07	External connection to logic and/or equipment

Table 1 footnotes

¹Communications between the Teach Pendant, controller and within the robot (between joints) are SIL 2 for safety data, per IEC 61784-3.

²Estop validation: the pendant Estop pushbutton is evaluated within the pendant, then communicated¹ to the safety controller by SIL2 communications. To validate the pendant Estop functionality, press the Pendant Estop pushbutton and verify that an Estop results. This validates that the Estop is connected within the pendant, the estop functions as intended, and the pendant is connected to the controller.

³Stop Categories according to IEC 60204-1 (NFPA79). For the Estop, only stop category 0 and 1 are allowed according to IEC 60204-1.

- Stop Category 0 and 1 result in the removal of drive power, with stop cat 0 being IMMEDIATE and stop cat 1 being a controlled stop (e.g. decelerate to a stop then removal of drive power). With UR robots, a stop category 1 is a controlled stop where power is removed when a monitored standstill is detected.
- Stop Category 2 is a stop where drive power is NOT removed. Stop category 2 is defined in IEC 60204-1. Descriptions of STO, SS1 and SS2 are in IEC 61800-5-2. With UR robots, a stop category 2 maintains the trajectory, then retains power to the drives after stopping.

⁴It is recommended to use the UR Stop Time and Stop Distance Safety Functions. These limits should be used for your application stop time/ safety distance values.

⁵Robot stop was previously known as "Protective stop" for Universal Robots robots.

15.1. Table 1a

Reduced Mode SF parameter settings change

Description	PFH _D	Affects
<p>Reduced Mode can be initiated by a safety plane/ boundary (starts at 2cm of the plane and reduced mode settings are achieved within 2cm of the plane) or by use of an input to initiate (will achieve reduced settings within 500ms). When the external connections are Low, Reduced Mode is initiated. Reduced Mode means that ALL reduced mode limits are ACTIVE.</p> <p>Reduced mode is not a safety function, rather it is a state change affecting the settings of the following safety function limits: joint position, joint speed, TCP pose limit, TCP speed, TCP force, momentum, power, stopping time, and stopping distance. Reduced mode is a means of parametrization of safety functions in accordance with ISO 13849-1. All parameter values need to be verified and validated as to whether they are appropriate for the robot application.</p>	Less than 1.8E-07	Robot

Safeguard Reset

Description	PFH _D	Affects
<p>When configured for Safeguard Reset and the external connections transition from low to high, the safeguard stop RESETS. Safety input to initiate a reset of safeguard stop safety function.</p>	Less than 1.8E-07 Input to SF2	Robot

3-Position Enabling Device INPUT

Description	PFH _D	Affects
<p>When the external Enabling Device connections are Low, a Safeguard Stop (SF2) is initiated.</p> <p>Recommendation: Use with a mode switch as a safety input. If a mode switch is not used and connected to the safety inputs, then the robot mode will be determined by the User Interface. If the User Interface is in:</p> <ul style="list-style-type: none"> • “running mode”, the enabling device will not be active. • “programming mode”, the enabling device will be active. It is possible to use password protection for changing the mode by the User Interface. 	Less than 1.8E-07 Input to SF2	Robot

Mode switch INPUT

Description	PFH _D	Affects
When the external connections are Low, Operation Mode (running/ automatic operation in automatic mode) is in effect. When High, mode is programming/ teach. Recommendation: Use with an enabling device, for example a UR e-Series Teach Pendant with an integrated 3-position enabling device. When in teach/program, initially both TCP speed and elbow speed will be limited to 250mm/s. The speed can manually be increased by using the pendant user interface “speed-slider”, but upon activation of the enabling device, the speed limitation will reset to 250mm/s.	Less than 1.8E-07 Input to SF2	Robot

Freedrive INPUT

Description	PFH _D	Affects
Recommendation: Use with 3PE TP and/or 3 Position Enabling Device INPUT. When Freedrive INPUT is High, the robot will only enter Freedrive if the following conditions are satisfied: <ul style="list-style-type: none"> • 3PE TP button is not pressed • 3 Position Enabling Device INPUT either not configured or not pressed (INPUT Low) 	Less than 1.8E-07 Input to SF2	Robot

15.2. Table 2

Description

UR e-Series robots comply with ISO 10218-1:2011 and the applicable portions of ISO/TS 15066. It is important to note that most of ISO/TS 15066 is directed towards the integrator and not the robot manufacturer. ISO 10218-1:2011, clause 5.10 collaborative operation details 4 collaborative operation techniques as explained below. It is very important to understand that collaborative operation is of the APPLICATION when in AUTOMATIC mode.

Collaborative Operation 2011 edition, clause 5.10.2

Technique	Explanation	UR e-Series
Safety-rated monitored stop	Stop condition where position is held at a standstill and is monitored as a safety function. Category 2 stop is permitted to auto reset. In the case of resetting and restarting operation after a safety -rated monitored stop, see ISO 10218-2 and ISO/TS 15066 as resumption shall not cause hazardous conditions.	UR robots’ safeguard stop is a safety-rated monitored stop, See SF2 on page 1. It is likely, in the future, that “safety-rated monitored stop” will not be called a form of collaborative operation.

**Collaborative
 Operation 2011
 edition, clause
 5.10.3**

Technique	Explanation	UR e-Series
Hand-guiding	This is essentially individual and direct personal control while the robot is in automatic mode. Hand guiding equipment shall be located close to the end-effector and shall have: <ul style="list-style-type: none"> • an Emergency Stop pushbutton • a 3-position enabling device • a safety-rated monitored stop function • a settable safety-rated monitored speed function 	UR robots do not provide hand-guiding for collaborative operation. Hand-guided teach (free drive) is provided with UR robots but this is for programming in manual mode and not for collaborative operation in automatic mode.

**Collaborative
Operation 2011
edition, clause
5.10.4**

Technique	Explanation	UR e-Series
<p>Speed and separation monitoring (SSM) safety functions</p>	<p>SSM is the robot maintaining a separation distance from any operator (human). This is done by monitoring of the distance between the robot system and intrusions to ensure that the MINIMUM PROTECTIVE DISTANCE is assured. Usually, this is accomplished using Sensitive Protective Equipment (SPE), where typically a safety laser scanner detects intrusion(s) towards the robot system. This SPE causes:</p> <ol style="list-style-type: none"> 1. dynamic changing of the parameters for the limiting safety functions; or 2. a safety-rated monitored stop condition. <p>Upon detection of the intrusion exiting the protective device's detection zone, the robot is permitted to:</p> <ol style="list-style-type: none"> 1. resume the "higher" normal safety function limits in the case of 1) above 2. resume operation in the case of 2) above <p>In the case of 2) 2), restarting operation after a safety -rated monitored stop, see ISO 10218-2 and ISO/TS 15066 for requirements.</p>	<p>To facilitate SSM, UR robots have the capability of switching between two sets of parameters for safety functions with configurable limits (normal and reduced). See Reduced Mode on page 4. Normal operation can be when no intrusion is detected. It can also be caused by safety planes/ safety boundaries. Multiple safety zones can be readily used with UR robots. For example, one safety zone can be used for "reduced settings" and another zone boundary is used as a safeguard stop input to the UR robot. Reduced limits can also include a reduced setting for the stop time and stop distance limits - to reduce the work area and floorspace.</p>



Collaborative Operation 2011 edition, clause 5.10.5

Technique	Explanation	UR e-Series
Power and force limiting (PFL) by inherent design or control	How to accomplish PFL is left to the robot manufacturer. The robot design and/or safety functions will limit the energy transfer from the robot to a person. If any parameter limit is exceeded, a robot stop happens. PFL applications require considering the ROBOT APPLICATION (including the end-effector and workpiece(s), so that any contact will not cause injury. The study performed evaluated pressures to the ONSET of pain, not injury. See Annex A. See ISO/TR 20218-1 End-effectors.	UR robots are power and force limiting robots specifically designed to enable collaborative applications where the robot could contact a person and cause no injury. UR robots have safety functions that can be used to limit motion, speed, momentum, force, power and more of the robot. These safety functions are used in the robot application to thereby lessen pressures and forces caused by the end-effector and workpiece(s).

Part II

PolyScope Manual

16. Introduction

Description

This software manual provides the essential information you need to start using your Universal Robots robot.



NOTICE

Before powering on the robot for the first time, please refer to the following sections:

- Read the safety information in the Hardware Description that you can find in the box.
- Set the safety configuration parameters defined by the risk assessment (see [17 Software Safety Configuration on page 133](#)).

All functions for using PolyScope can be found in this manual.

Please refer to the 3rd party provider of any URcaps for their propriety documentation.

The software manual may be used together with the [Script Manual](#), if you are going to create scripts for your robot programs

16.1. Robot Arm Basics

Description

The Universal Robots robot arm is composed of tubes and joints. You use the PolyScope to coordinate the motion of these joints to move the robot arm. You attach tools to end of the robot arm, or Tool Flange . Moving the robot arm positions the tool. You cannot position the tool directly above, or directly below the Base.

- **Base**: where the robot is mounted.
- **Shoulder** and **Elbow**: make larger movements.
- **Wrist 1** and **Wrist 2**: make finer movements.
- **Wrist 3**: where the tool is attached to the Tool Flange.

16.2. Robot Arm Installation

Description Install and power on the robot arm and Control Box to start using PolyScope. See **Hardware Installation Manual** for detailed installation instructions.

Install the robot You have to assemble the robot arm, Control Box and Teach Pendant to be able to continue.

1. Unpack the robot arm and the Control Box.
2. Mount the robot arm on a sturdy, vibration-free surface.

Verify the surface can withstand at least 10 times the full torque of the base joint and at least 5 times the weight of the robot arm.

3. Place the Control Box on its Foot.
4. Connect the robot cable to the robot arm and the Control Box.
5. Plug in the mains, or main power cable, of the Control Box.



WARNING

Failure to secure the robot arm to a sturdy surface can lead to injury caused by the robot falling.

- Ensure the robot arm is secured to a sturdy surface

Turning the control box on/off The Control Box mainly contains the physical electrical Input/Output that connects the robot arm, the Teach Pendant and any peripherals. You must turn on the Control Box to be able to power on the robot arm.

1. On your Teach Pendant, press the power button to turn on the control box.
2. Wait as text from the underlying operating system, followed by buttons, appear on the screen.
3. A Getting Started screen can appear, prompting you to begin programming the robot.

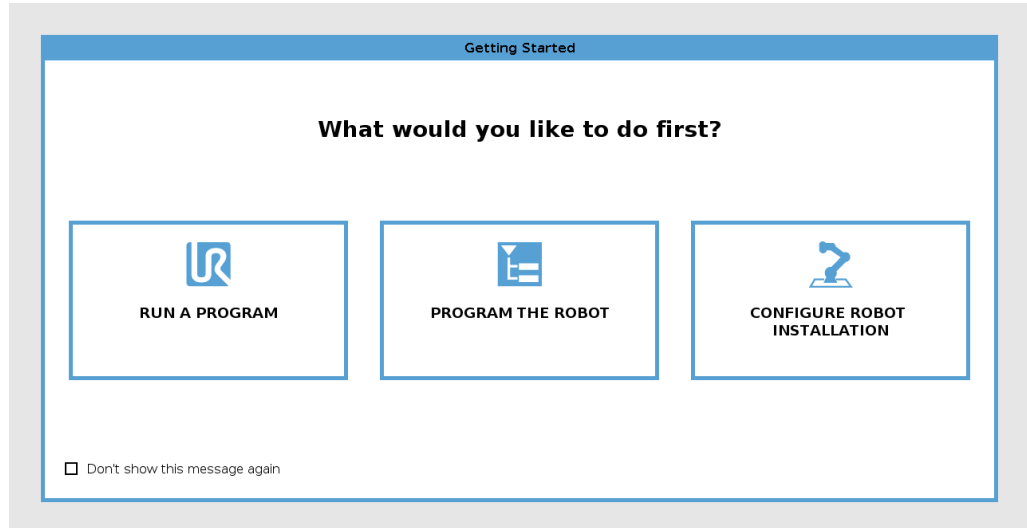

Initialization

On your first start up a Cannot Proceed dialog box can appear. Select **Go to initialization screen** to access the Initialize screen.

In the Footer, to the left, the Initialize button indicates the status of the robot arm using colors:

- **Red** Power off. The robot arm is in a stopped state.
- **Yellow** Idle. The robot arm is on, but not ready for normal operation.
- **Green** Normal. The robot arm is on and ready for normal operation.

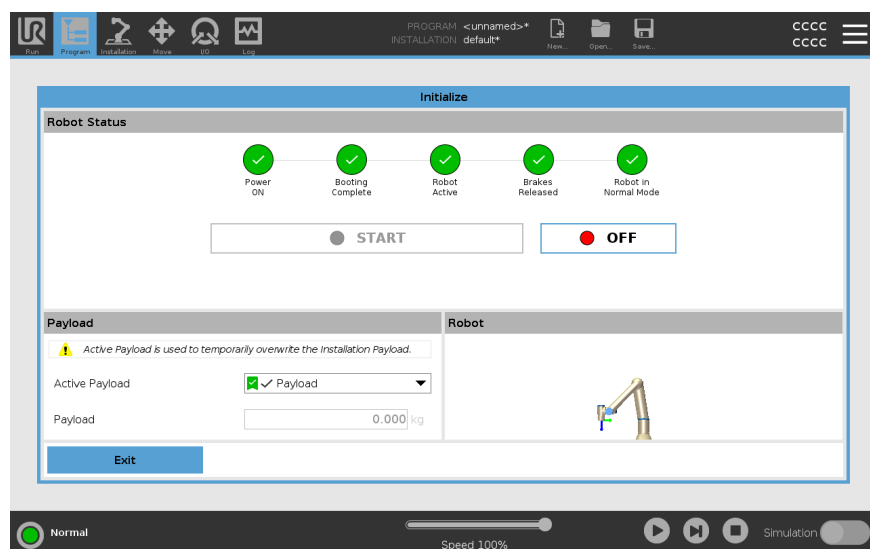

Start up

You have to start the robot. This disengages the braking system, and makes the robot able to engage freedrive.

**CAUTION**

Failure to verify the payload and installation before starting up the robot arm can lead to injury to personnel and/or property damage.

- Always verify the actual payload and installation are correct before starting up the robot arm.

**CAUTION**

Incorrect payload and installation settings prevent the robot arm and Control Box functioning correctly.

- Always verify the payload and installation setting are correct.

**NOTICE**

Verify the robot arm has ample space to operate freely.

**NOTICE**

Starting up the robot in lower temperatures can result in lower performance, or stops, due to temperature dependent oil and grease viscosity.

- Starting up the robot in low temperatures can require a warm-up phase.

See the support article, "Best Practice for Robot Start-up in Cold Environments" on universal-robots.com

To start the robot

1. Tap the ON button with the green LED to start the initialization process. Then, the LED turns yellow to indicate the power is on and in **Idle**.
2. Tap the START button to release the breaks.
3. Tap the OFF button with the red LED to power off the robot arm.
 - When the PolyScope starts, tap the ON button once to power the robot arm. Then, the status changes to yellow to indicate the robot is on and idle.
 - When the robot arm state is **Idle**, tap the START button to start robot arm. At this point, sensor data is checked against the configured mounting of the robot arm. If a mismatch is found (with a tolerance of 30°), the button is disabled and an error message is displayed below it.
 - If the mounting is verified, tap Start to release all joint brakes and the robot arm is ready for normal operation.

Robot arm start up is accompanied by sound and slight movements as joint brakes are released.

16.3. PolyScope Overview

Description

PolyScope is the Graphical User Interface (GUI) on the **Teach Pendant** that operates the robot arm via a touch screen. You create, load and execute programs for the robot in PolyScope. The PolyScope interface is divided as shown in the following illustration:

- A: **Header** with icons/tabs that make interactive screens available to you.
- B: **Footer** with buttons that control your loaded program/s.
- C: **Screen** with fields and options to manage and monitor robot actions.

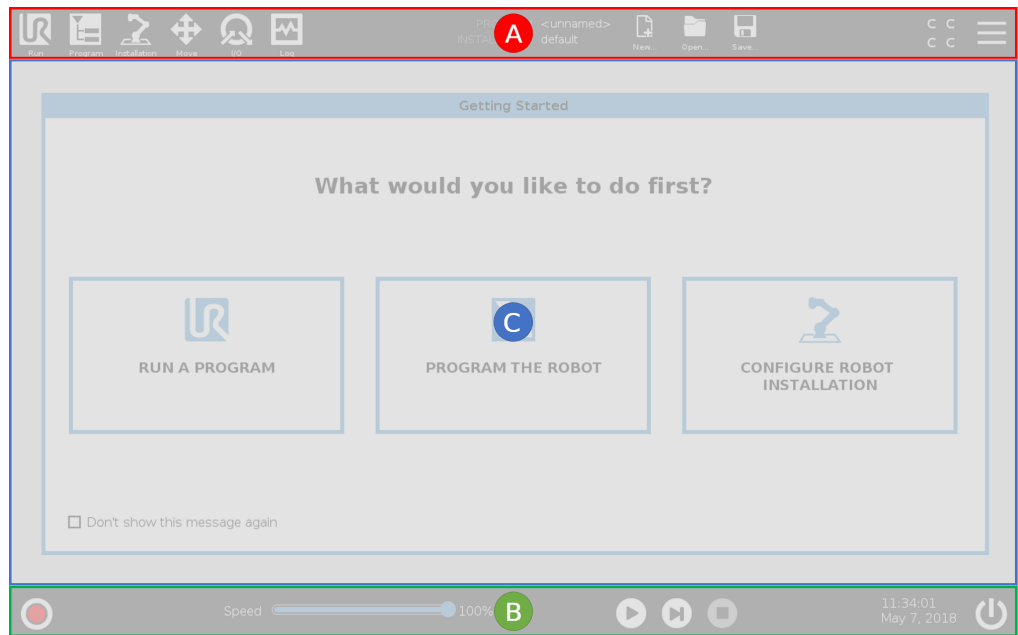

Using the Touch Screen

The touch sensitivity is designed to avoid false selections on PolyScope, and to prevent unexpected motion of the robot.

The Teach Pendant touch screen is optimized for use in industrial environments. Unlike consumer electronics, Teach Pendant touch screen sensitivity is, by design, more resistant to environmental factors such as:

- water droplets and/or machine coolant droplets
- radio wave emissions
- other conducted noise from the operating environment.

For best results, use the tip of your finger to make a selection on the screen. In this manual, this is referred to as a "tap".

A commercially available stylus may be used to make selections on the screen if desired.

16.3.1. Icons/Tabs On PolyScope

Description

The following section lists and defines the icons/tabs and buttons in the PolyScope interface.

Header Icons / Functions



Run is a simple means of operating the robot using pre-written programs.



Program creates and/or modifies robot programs.



Installation configures robot arm settings and external equipment e.g. mounting and safety.



Move controls and/or regulates robot movement.



I/O monitors and sets live Input/Output signals to and from robot control box.



Log indicates robot health as well as any warning or error messages.



Program and Installation Manager

selects and displays active program and installation (see [24.1 File Manager on page 330](#)). The Program and Installation Manager includes: File Path, New, Open and Save.



New... creates a new Program or Installation.



Open... opens a previously created and saved Program or Installation.



Save... saves a Program, Installation or both at the same time.

Operational modes



Automatic indicates the operational mode of the robot is set to Automatic. Tap it to switch to the Manual operational mode.



Manual indicates the operational mode of the robot is set to Manual. Tap it to switch to the Automatic operational mode.

Remote Control

The Local mode and Remote mode icons only become accessible if you enable Remote Control.



Local indicates the robot can be controlled locally. Tap it to switch to Remote control.



Remote indicates the robot can be controlled from a remote location. Tap it to switch to Local control.



Safety Checksum displays the active safety configuration.



Hamburger Menu accesses PolyScope Help, About and Settings.

Footer Icons / Functions



Initialize manages robot state. When RED, press it to make the robot operational.

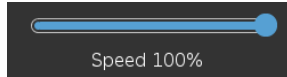

Speed Slider shows in real time the relative speed at which the robot arm moves, taking safety settings into account.



Simulation button toggles a program execution between Simulation Mode and the Real Robot. When running in Simulation Mode, the Robot Arm does not move. Therefore, the robot cannot damage itself or nearby equipment in a collision. If you are unsure what the Robot Arm will do, use Simulation Mode to test programs.



Play starts current loaded robot Program.



Step allows a Program to be run single-stepped.



Stop halts current loaded robot Program.

Manual High Speed

Manual High Speed is a hold-to-run function, only available in Manual mode when a Three-Position Enabling Device is configured.



250mm/s Manual High Speed allows both tool speed and elbow speed to temporarily exceed 250mm/s.

16.4. Freedrive

Description

Freedrive allows the robot arm to be manually pulled into desired positions and/or poses.

The joints move with little resistance because the brakes are released. While the robot arm is being moved manually, it is in Freedrive (see [Operational mode on page 130](#)). As the robot arm in Freedrive approaches a predefined limit or plane (see [17.8 Software Safety Restrictions on page 149](#)), resistance increases. This makes pulling the robot into position feel heavy.



WARNING

Injury to personnel can occur due to unexpected motion.

- Verify the configured payload is the payload being used.
- Verify the correct payload is securely attached to the tool flange.

Enabling Freedrive

You can enable Freedrive in the following ways:

- Use the 3PE Teach Pendant
- Use the Freedrive on robot (see [17.7 Safety I/O on page 145](#))
- Use I/O Actions (see [20.4 I/O Setup on page 281](#))



NOTICE

Enabling Freedrive while you are moving the robot arm, can cause it to drift leading to faults.

- Do not enable Freedrive while you are pushing or touching the robot.

3PE Teach Pendant

To use the 3PE TP button to freedrive the robot arm:

1. Rapidly light-press, then light-press-and-hold, the 3PE button.

Now you can pull the robot arm into a desired position, while the light-press is maintained.



Freedrive on robot

To use Freedrive on robot to freedrive the robot arm:

1. Press-and-hold the button of switch configured for **Freedrive on robot**.
2. When the Freedrive panel appears in PolyScope, select the desired movement type for the robot arm's joints. Or use the list of axes to customize the movement type.
3. You can define the type of feature if required, by selecting an option from the Feature dropdown list.

The robot arm can stop moving if it approaches a singularity scenario. Tap **All axes are free** in the Freedrive panel (see [16.4.1 Freedrive Panel on page 121](#)) to resume movement.

4. Move the robot arm as desired.
-

Backdrive

During initialization of the robot arm, minor vibrations may be observed when the robot brakes are released. In some situations, such as when the robot is close to collision, these vibrations are undesirable. Use Backdrive to force specific joints to a desired position without releasing all brakes in the robot arm.

For Backdrive methods, see [16.5 Backdrive on page 122](#)

16.4.1. Freedrive Panel

Description

When the robot arm is in Freedrive, a panel appears on PolyScope, as illustrated below.

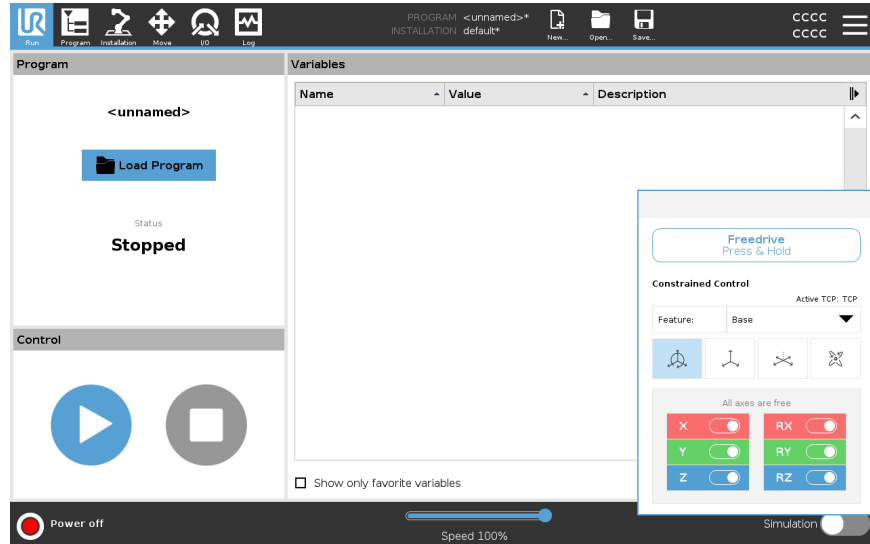

LED Freedrive panel



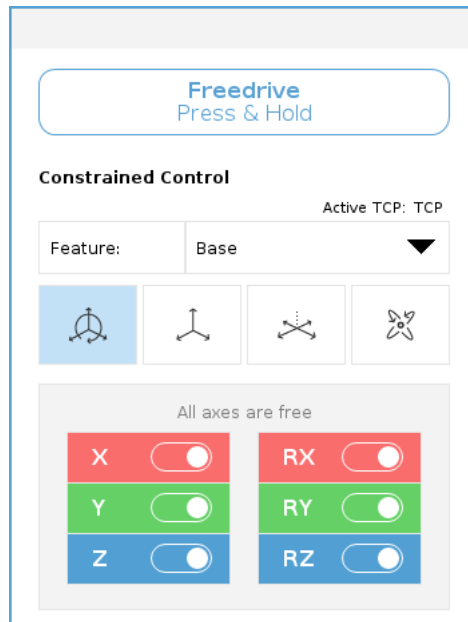

The LED on the status bar of the Freedrive panel indicates:

- When one or more joints are approaching their joint limits.
- When the robot arm's positioning is approaching singularity. Resistance increases as the robot approaches singularity, making it feel heavy to position.



Icons

You can lock one or more of the axes allowing the TCP to move in a particular direction, as defined in the table below.

 All axes are free	Movement is allowed through all axes.
 Plane	Movement is only allowed through the X-axis and Y-axis.
 Translation	Movement is allowed through all axes, without rotation.
 Rotation	Movement is allowed through all axes, in a spherical motion, around the TCP.



CAUTION

Moving the robot arm in some axes when a tool is attached, can present a pinch point.

- Use caution when moving the robot arm in any axis.

16.5. Backdrive

Description

Backdrive is used to force specific joints to a desired position without releasing all brakes in the robot arm. This is sometimes necessary if the robot arm is close to collision and the vibrations that accompany a full restart are not desired. The robot joints feel heavy to move, while Backdrive is in use.

You can use any of the following methods to enable Backdrive:

- 3PE Teach Pendant
- 3PE device/switch
- Freedrive on robot

3PE Teach Pendant

To use the 3PE TP button to backdrive the robot arm.

1. On the Initialize screen, tap **ON** to start the power up sequence.
2. When the robot state is **Teach Pendant 3PE Stop**, light-press, then light-press-and-hold, the 3PE TP button.
The robot state changes to **Backdrive**.
3. Now you can apply significant pressure to release the brake in a desired joint to move the robot arm.
As long as light-press is maintained on the 3PE button, Backdrive is enabled, allowing the arm to move.

3PE device/switch

To use a 3PE device/switch to backdrive the robot arm.

1. On the Initialize screen, tap **ON** to start the power up sequence.
2. When the robot state is **Teach Pendant 3PE Stop**, light-press, then light-press-and-hold, the 3PE TP button.
The robot state changes to **System 3PE Stop**.
3. Press and hold the 3PE device/switch.
The robot state changes to **Backdrive**.
4. Now you can apply significant pressure to release the brake in a desired joint to move the robot arm.
As long as the hold is maintained on both the 3PE device/switch and the 3PE TP button, Backdrive is enabled, allowing the arm to move.

Freedrive on robot

To use Freedrive on robot to backdrive the robot arm.

1. On the Initialize screen, tap **ON** to start the power up sequence.
2. When the robot state is **Teach Pendant 3PE Stop**, press and hold the **Freedrive on robot**.
The robot state changes to **Backdrive**.
3. Now you can apply significant pressure to release the brake in a desired joint to move the robot arm.
As long as the hold is maintained on the Freedrive on robot, Backdrive is enabled, allowing the arm to move.

16.5.1. Backdrive Inspection

Description

If the robot is close to colliding with something, you can use Backdrive to move the robot arm to a safe position before initializing.

3PE Teach Pendant

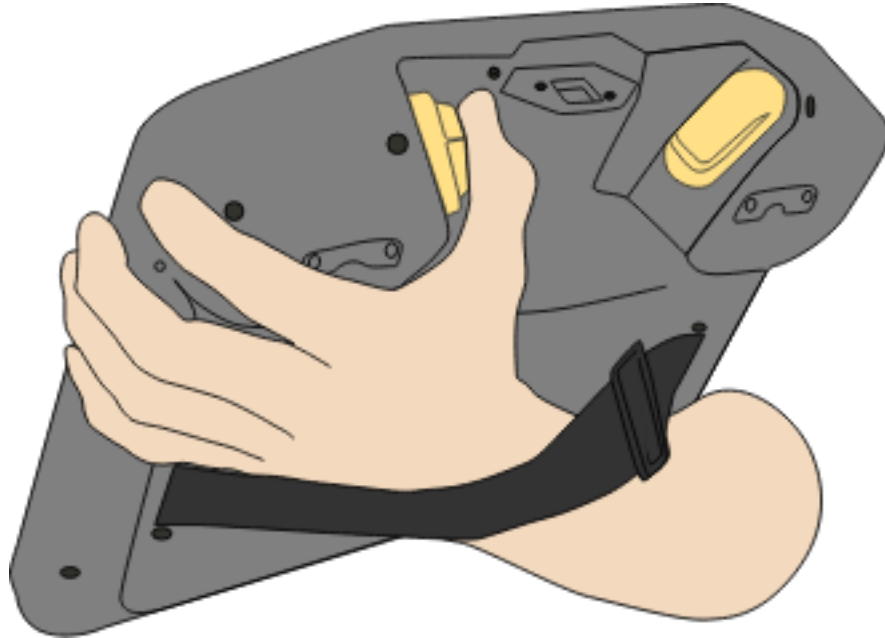

Enable Backdrive

1. Press ON to enable power. Status changes to *Robot Active*

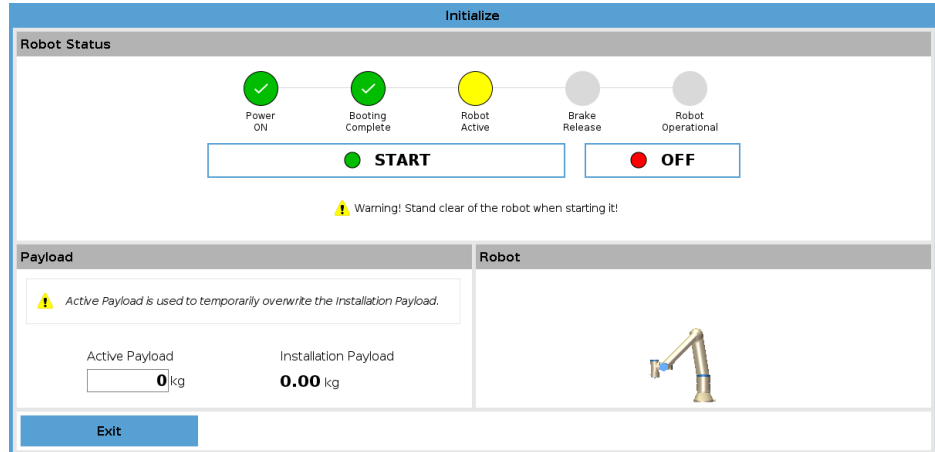

2. Press and hold Freedrive. Status changes to *Backdrive*

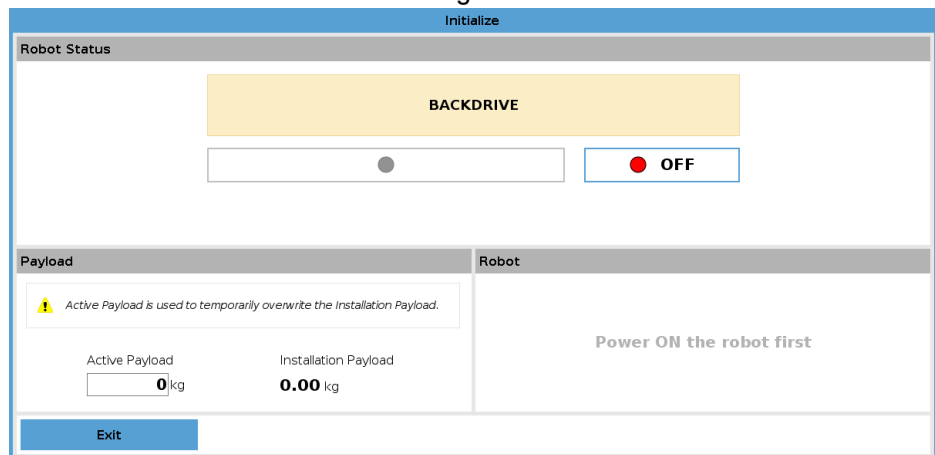

3. Move robot as in Freedrive mode. Joint brakes are released where needed once the Freedrive button is activated.



NOTICE

In Backdrive Mode the robot is “heavy” to move around.

MANDATORY ACTION

You must test Backdrive mode on all joints.

Safety settings

Verify the robot safety settings comply with the robot installation risk assessment.

Additional safety inputs and outputs are still functioning

Check which safety inputs and outputs are active and that they can be triggered via PolyScope or external devices.

16.6. Quick System Start-up

Quick System Start

MANDATORY ACTION

Before using the PolyScope, verify the robot arm and Control Box are correctly installed.

This is how you quickly start up the robot.

1. On the **Teach Pendant**, press the emergency stop button.
2. On the Teach Pendant, press the power button and allow the system to start, displaying text on the **PolyScope**.
3. A popup appears on the touch screen indicating that the system is ready and that the robot must be initialized.
4. In the popup dialog, tap **Go to Initialize Screen** to access the Initialize screen.
5. Unlock the emergency stop button to change robot state from **Emergency Stopped** to **Power off**.
6. Step outside the reach (workspace) of the robot.
7. On the **Initialize Robot** screen, tap the **ON** button and allow robot state to change to **Idle**.
8. In the **Payload** field, in **Active Payload**, verify the payload mass. You can also verify the mounting position is correct, in the **Robot** field.
9. Tap the **Start** button, for the robot to release its brake system. The robot vibrates and makes clicking sounds indicating it is ready to be programmed.



NOTICE

Learn to program your Universal Robots robot on www.universal-robots.com/academy/

16.7. The First Program

Description

A program is a list of commands telling the robot what to do. For most tasks, programming is done entirely using the PolyScope software. PolyScope allows you to teach the robot arm how to move using a series of waypoints to set up a path for the robot arm to follow.

Use the Move tab (see [21 Move Tab on page 314](#)) to move the Robot Arm to a desired position, or teach the position by pulling the Robot Arm into place while holding down the Freedrive button at the top of the Teach Pendant.

You can create a program can to send I/O signals to other machines at certain points in the robot's path, and perform commands like **if...then** and **loop**, based on variables and I/O signals.

To create a simple program

1. On PolyScope, in the Header **File Path**, tap **New...** and select **Program**.
2. Under Basic, tap **Waypoint** to add a waypoint to the program tree. A default MoveJ is also added to the program tree.
3. Select the new waypoint and in the Command tab, tap **Waypoint**.
4. On the Move Tool screen, move the robot arm by pressing the move arrows. You can also move the robot arm by holding down the Freedrive button and pulling the Robot Arm into desired positions.
5. Once the robot arm is in position, press **OK** and the new waypoint displays as Waypoint_1.
6. Follow steps 2 to 5 to create Waypoint_2.
7. Select Waypoint_2 and press the Move Up arrow until it is above Waypoint_1 to change the order of the movements.
8. Stand clear, hold on to the emergency stop button and in the PolyScope Footer, press **Play** button for the Robot Arm to move between Waypoint_1 and Waypoint_2.
Congratulations! You have now produced your first robot program that moves the Robot Arm between the two given waypoints.

**NOTICE**

1. Do not drive the robot into itself or anything else as this may cause damage to the robot.
2. This is only a quick start guide to show how easy it is to use a UR robot. It assumes a harmless environment and a very careful user. Do not increase the speed or acceleration above the default values. Always conduct a risk assessment before placing the robot into operation.

**WARNING**

Keep your head and torso outside the reach (workspace) of the robot.
Do not place fingers where they can be caught.

16.8. Robot Cyber Security

Description

Before implementing cyber security, you must conduct a risk assessment to:

- Identify threats
- Define trust zones and conduits
- Specify the requirements of each component in the application

Cyber Security Pre-requisites

Before your system can reach a secure state of operation, ensure the following:

- You have a thorough understanding of general cyber security principles and advanced technologies as used in your Universal Robots robot.
- You take physical security measures to allow only trusted personnel physical access to the robot.
- You only connect your robot to a trusted network, behind a firewall restricting both inbound and outbound access to/from the Internet.

Hardening Cyber Security

Although PolyScope includes many features for keeping the network connection secure, you can harden security by observing to following guidelines:

- Always set an Admin password (see [25.2 Settings on page 334](#)) before connecting your robot to any network.
- Use the built-in settings to restrict the network access to the robot as much as possible.
- Some communication interfaces have no method of authenticating connections made. In some applications this is a security liability.
- Use local port forwarding (see [25.2 Settings on page 334](#)) to setup an authenticated and secure connection, if you require remote access to the motion controlling interfaces of the robot. For example: the Dashboard Server and the Primary/Secondary/Realtime Client Interfaces.
- Remove sensitive data from the robot before it is decommissioned. Pay particular attention to the URCaps (see [19.10 URCaps on page 265](#)) and data in the program folder.

16.9. Operational Mode Selection

Description

Operational Modes are enabled when you configure a Three-Position Enabling Device, set a password, define an Operational Mode Configurable I/O, or via the Dashboard Server. (see [Using the Dashboard Server on page 132](#))

You can set the robot in automatic mode and in manual mode:

Automatic Mode Once activated, the robot can only perform pre-defined tasks. The Move Tab and Freedrive Mode are unavailable if a Three-Position Enabling Device is configured. You cannot modify or save programs and installations.

Manual Mode Once activated, you can program the robot using the Move Tab, Freedrive Mode and Speed Slider. You can modify and save programs and installations.



WARNING

Automatic Mode Safeguard Stop can only be activated in Automatic Mode, so the safeguard's protective function is only active in Automatic Mode.

Mode switching

Operational mode	Manual	Automatic
Freedrive	x	*
Move robot with arrows on Move Tab	x	*
Speed Slider	x	x**
Edit & save program & installation	x	
Execute Programs	Reduced speed***	*
Start program from selected node	x	

*Only when no Three-Position Enabling Device is configured.

** The Speed Slider on the Run Screen can be enabled in the PolyScope Settings.

*** If a Three-Position Enabling Device is configured, the robot operates at Manual Reduced Speed unless Manual High Speed is activated.

Notice when switching mode

NOTICE

- A Universal Robots robot may not be equipped with a Three-Position Enabling Device. If the risk assessment requires the device, it must be attached before the robot is used.
- If a Three-Position Enabling Device is not configured, speed is not reduced in Manual Mode.

WARNING

- Any suspended safeguards must be returned to full functionality before selecting Automatic Mode.
- Wherever possible, the Manual Mode of operation shall be performed with all persons outside the safeguard space.
- The device used to switch between Operational Modes must be placed outside the safeguarded space.
- The user must not enter the safeguarded space when robot is in Automatic Mode, unless an Automatic Mode Safeguard input is configured.

The methods for configuring Operational Mode selection are described in the following subsections. Each method is exclusive, meaning that using one method, makes the other two methods inactive.

Using Operational Mode Safety Input

1. Tap the Installation Tab, and select Safety I/O.
2. Configure the Operational Mode Input. The option to configure appears in the drop-down menu.
 - The robot is in Automatic Mode when the Operational Mode Input is low.
 - The robot is in Manual Mode when the Operational Mode Input is high.

NOTICE

The physical mode selector, if used, must completely adhere to ISO 10218-1: article 5.7.1 for selection.

Switching Modes

1. To switch between modes, in the Header, select the profile icon.
 - **Automatic** indicates the operational mode of the robot is set to Automatic.
 - **Manual** indicates the operational mode of the robot is set to Manual.

PolyScope is automatically in Manual Mode when the Safety I/O configuration with Three-Position Enabling Device is enabled.



Using the Dashboard Server

1. Connect to the Dashboard server.
2. Use the **Set Operational Mode** commands.
 - Set Operational Mode Automatic
 - Set Operational Mode Manual
 - Clear Operational Mode

See <http://universal-robots.com/support/> for more on using the Dashboard server.

Three-Position Enabling Device

When a Three-Position Enabling Device is configured and the **Operational Mode** is in Manual Mode, the robot can only be moved by pressing the Three-Position Enabling Device. Connecting and configuring a Three-Position Enabling Device makes Automatic Mode Safeguard Stop accessible. The Three-Position Enabling Device has no effect in Automatic Mode.

Manual High Speed

The hold-to-run function, **Manual High Speed**, allows both tool speed and elbow speed to temporarily exceed 250mm/s. It is only available when your robot is in Manual mode and a Three-Position Enabling Device is configured. The robot performs a Safeguard Stop in Manual mode, if a Three-Position Enabling Device is configured, but not pressed. Switching between Automatic mode to Manual mode requires the Three-Position Enabling Device to be fully released and pressed again to allow the robot to move. When using Manual High Speed, use safety joint limits (see [17.6.2 Joint Limits on page 142](#)) or safety planes (see [Safety Planes Modes on page 150](#)) to restrict the robot's moving space.

17. Software Safety Configuration

Description

This section covers how to access the robot safety settings. It is made up of items that help you set up the robot Safety Configuration.



WARNING

Before you configure your robot safety settings, your integrator must conduct a risk assessment to guarantee the safety of personnel and equipment around the robot. A risk assessment is an evaluation of all work procedures throughout the robot lifetime, conducted in order to apply correct safety configuration settings. You must set the following in accordance with the integrator's risk assessment.

1. The integrator must prevent unauthorized persons from changing the safety configuration e.g. installing password protection.
2. Use and configuration of the safety-related functions and interfaces for a specific robot application.
3. Safety configuration settings for set-up and teaching before the robot arm is powered on for the first time.
4. All safety configuration settings accessible on this screen and sub-tabs.
5. The integrator must ensure that all changes to the safety configuration settings comply with the risk assessment. See Hardware Installation Manual.

Accessing Software Safety Settings

Safety Settings are password protected and can only be configured once a password is set and subsequently used.

To access the software safety settings

1. In your PolyScope header, tap the **Installation** icon.
2. In the Side Menu on the left of the screen, tap **Safety**.
3. Observe that the **Robot Limits** screen displays, but settings are inaccessible.
4. If a **Safety password** was previously set, enter the password and press **Unlock** to make settings accessible. Note: Once Safety settings are unlocked, all settings are now active.
5. Press **Lock** tab or navigate away from the Safety menu to lock all Safety item settings again.

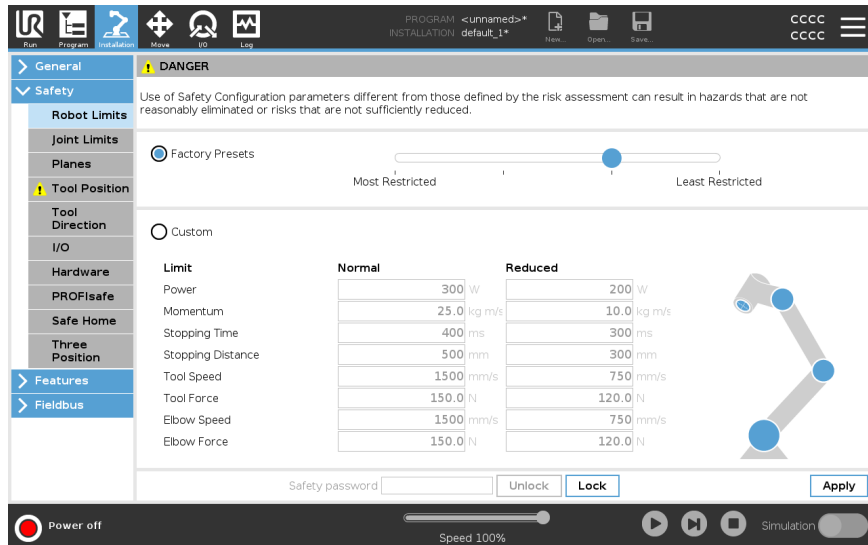

You can find more safety system information in the [Hardware Installation Manual](#).

17.1. Setting a Software Safety Password

Description You must set a password to Unlock all safety settings that make up your Safety Configuration. If no safety password is applied, you are prompted to set it up.

To set a Software Safety password You can tap the **Lock** tab to lock all Safety settings again or simply navigate to a screen outside of the Safety menu.

1. In your PolyScope header right corner, press the **Hamburger** menu and select **Settings**.
2. On the left of the screen, in the blue menu, press **Password** and select **Safety**.
3. In **New password**, type a password.
4. Now, in **Confirm new password**, type the same password and press **Apply**.
5. In the bottom left of the blue menu, press **Exit** to return to previous screen.

Safety password

17.2. Changing the Software Safety Configuration

Description Changes to the Safety Configuration settings must comply with the risk assessment conducted by the integrator (see [Hardware Installation Manual](#)).

Recommended procedure for the integrator:

To change the safety configuration

1. Verify that changes comply with the risk assessment conducted by the integrator.
2. Adjust safety settings to the appropriate level defined by the risk assessment conducted by the integrator.
3. Verify that the settings are applied.
4. Place following text in the operators' manuals:

Before working near the robot, make sure that the safety configuration is as expected. This can be verified e.g. by inspecting the Safety Checksum in the top right corner of PolyScope for any changes. (See [17.3.1 Safety Checksum on page 137](#)).

17.3. Applying a New Software Safety Configuration

Description

The robot is powered off while you make changes to the configuration.

Your changes only take effect after you tap the **Apply** button.

The robot cannot be powered on again until you select **Apply and Restart** to visually inspect your robot Safety Configuration which, for safety reasons, is displayed in SI Units in a popup.

You can select **Revert Changes** to return to the previous configuration. When your visual inspection is complete you can select **Confirm Safety Configuration** and the changes are automatically saved as part of the current robot installation.

17.3.1. Safety Checksum

Description

The **Safety Checksum** icon displays your applied robot safety configuration.



It could be four or eight digits.

A four-digit Checksum should be read from top to bottom and left to right, while an eight-digit Checksum is read left to right, top row first. Different text and/or colors indicate changes to the applied safety configuration.

The **Safety Checksum** changes if you change the **Safety Functions** settings, because the **Safety Checksum** is only generated by the safety settings.

You must apply your changes to the **Safety Configuration** for the **Safety Checksum** to reflect your changes.



17.4. Safety Configuration without Teach Pendant

Description

You can use the robot without attaching the Teach Pendant. Removing the Teach Pendant requires defining another Emergency Stop source. You must specify if the Teach Pendant is attached to avoid triggering a safety violation.



CAUTION

If the Teach Pendant is detached or disconnected from the robot, the Emergency Stop button is no longer active. You must remove the Teach Pendant from the vicinity of the robot.

To safely remove the Teach Pendant

The robot can be used without PolyScope as the programming interface. To configure the robot without a Teach Pendant

1. In the Header tap **Installation**.
2. In the Side Menu on left tap **Safety** and select **Hardware**.
3. Input Safety password and **Unlock** the screen.
4. Deselect **Teach Pendant** to use robot without PolyScope interface.
5. Press **Save and restart** to implement changes.

17.5. Software Safety Modes

- Description** Under normal conditions, i.e. when no ¹robot stop is in effect, the safety system operates in a Safety Mode associated with a set of safety limits:
- **Normal mode** is the safety mode that is active by default
 - **Reduced mode** is active when the robot **Tool Center Point** (TCP) is positioned beyond a Trigger Reduced mode plane (see [17.8 Software Safety Restrictions on page 149](#)), or when triggered using a configurable input (see [17.7 Safety I/O on page 145](#))
 - **Recovery mode** activates when a safety limit from the active limit set is violated, the robot arm performs a Stop Category 0. If an active safety limit, such as a joint position limit or a safety boundary, is violated already when the robot arm is powered on, it starts up in **Recovery mode**. This makes it possible to move the robot arm back within the safety limits. While in Recovery mode, the movement of the robot arm is restricted by a fixed limit that you cannot customize.

**WARNING**

Limits for **joint position**, **tool position** and **tool orientation** are disabled in Recovery mode, so take caution when moving the robot arm back within the limits.

The menu of the Safety Configuration screen enables the user to define separate sets of safety limits for Normal and Reduced mode. For the tool and joints, Reduced mode limits for speed and momentum are required to be more restrictive than their Normal mode counterparts.

17.6. Software Safety Limits

- Description** In the Safety Configuration the safety system limits are specified. The *Safety System* receives the values from the input fields and detects any violation if any these values are exceeded. The robot controller attempts to prevent any violations by making a robot stop or by reducing the speed.

17.6.1. Robot Limits

- Description** Robot Limits restrict general robot movements. The Robot Limits screen has two configuration options: **Factory Presets** and **Custom**.

¹Robot stop was previously known as "Protective Stop" for Universal Robots robots.

Factory Presets Factory Presets is where you can use the slider to select a predefined safety setting . The values in the table are updated to reflect the preset values ranging from **Most Restricted** to **Least Restricted**



NOTICE

Slider values are only suggestions and do not substitute a proper risk assessment.

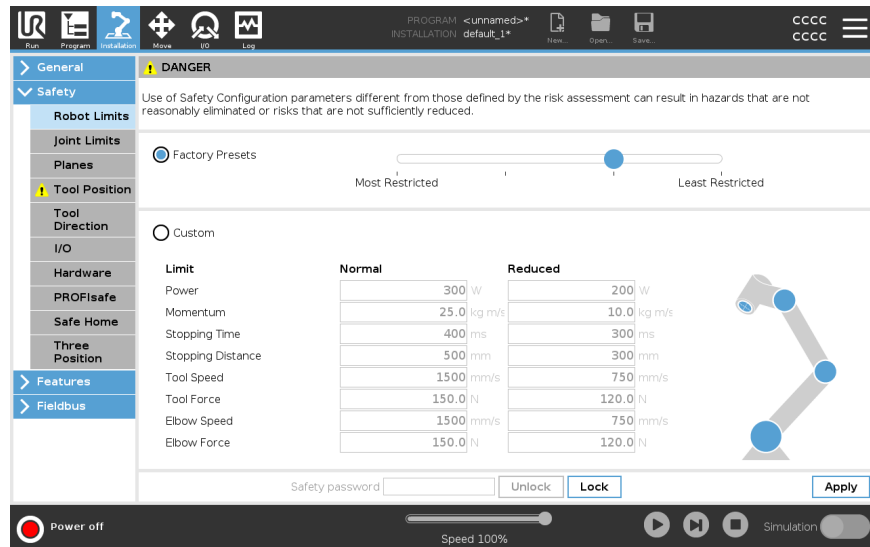

Custom Custom is where you can set Limits on how the robot functions and monitor the associated Tolerance.

Power

limits maximum mechanical work produced by the robot in the environment. This limit considers the payload a part of the robot and not of the environment.

Momentum

limits maximum robot momentum.

Stopping Time

limits maximum time it takes the robot to stop e.g. when an emergency stop is activated.

Stopping Distance

limits maximum distance the robot tool or elbow can travel while stopping.



NOTICE

Restricting stopping time and distance affect overall robot speed. For example, if stopping time is set to 300 ms, the maximum robot speed is limited allowing the robot to stop within 300 ms.

Tool Speed

limits maximum robot tool speed.

Tool Force

limits the maximum force exerted by the robot tool in clamping situations. Limited to 250.

Elbow Speed

limits maximum robot elbow speed.

Elbow Force

limits maximum force that the elbow exerts on the environment. Limited to 250 N.

The tool speed and force are limited at the tool flange and the center of the two user-defined tool positions, (see [17.8.2 Tool Position Restriction on page 159](#)).

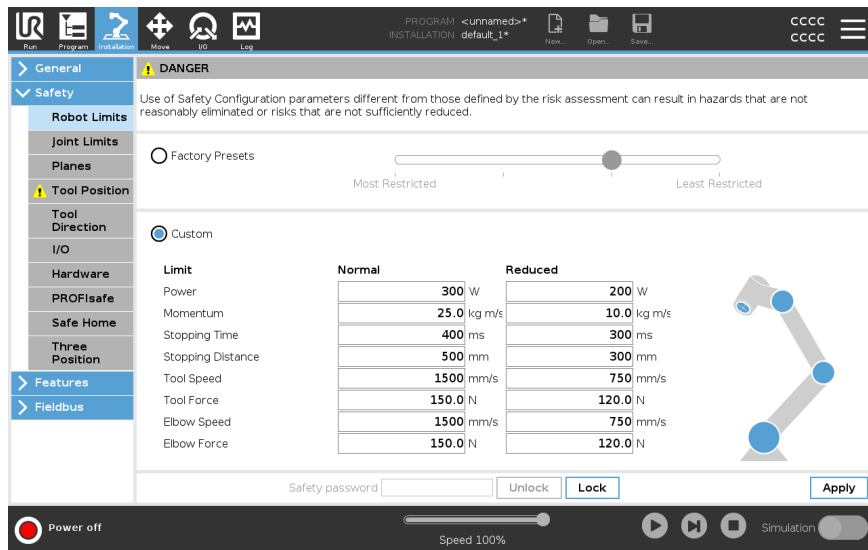

NOTICE

You can switch back to **Factory Presets** for all robot limits to reset to their default settings.

17.6.2. Joint Limits

Description

Joint Limits allow you to restrict individual robot joint movements in joint space i.e. joint rotational position and joint rotational speed. There are two Joint Limits options: **Maximum speed** and **Position range**.

Wrist 3 position range

When using cables attached to the robot, you must first disable the **Unrestricted Range** for **Wrist 3** checkbox to avoid cable tension and robot stops.

1. Maximum speed is where you define the maximum angular velocity for each joint.
2. Position range is where you define the position range for each joint. Again, the input fields for Reduced mode are disabled if there is no safety plane or configurable input set to trigger it. This limit enables safety-rated soft axis limiting of the robot.

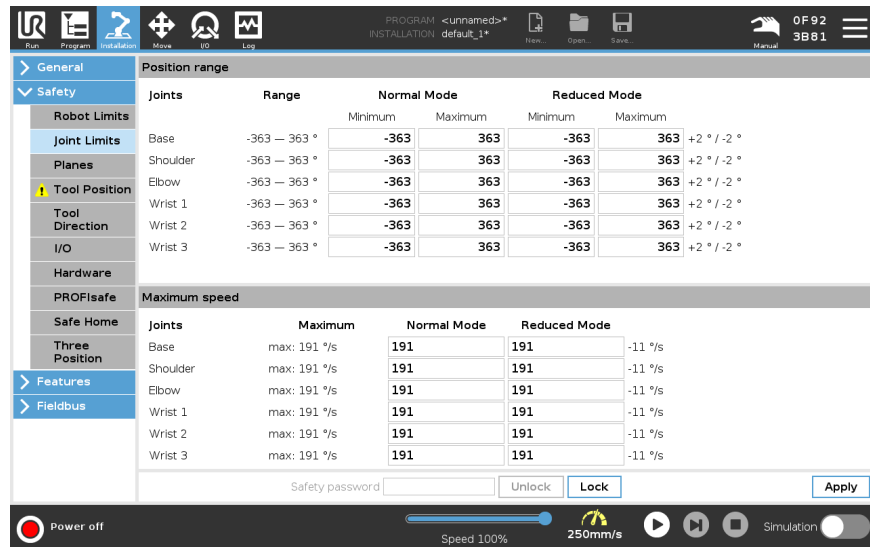



17.7. Safety I/O

Description

The I/O are divided between inputs and outputs and are paired up so that each function provides a Category 3 and PLd I/O.

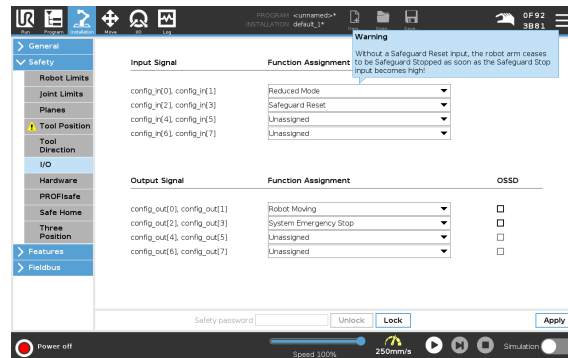

Input Signals

The following Safety Functions can be used with the input signals:

System Emergency Stop

This is an emergency stop button alternative to the one on the Teach Pendant, providing the same functionality if the device complies with ISO 13850.

Reduced

All safety limits can be applied while the robot is using a **Normal** configuration, or a **Reduced** configuration (see [17.5 Software Safety Modes on page 139](#)). When configured, a low signal sent to the inputs causes the safety system to transition to the reduced configuration. The robot arm decelerates to satisfy the reduced parameters.

The safety system guarantees the robot is within reduced limits less than 0.5s after the input is triggered. If the robot arm continues to violate any of the reduced limits, a Stop Category 0 is triggered.

Trigger planes can also cause a transition to the reduced configuration. The safety system transitions to the normal configuration in the same way.

3-Position Enabling Device

In Manual Mode, an external 3-Position Enabling Device must be pressed and held in the center-on position to move the robot.

If you are using a built-in 3-Position Enabling Device, the button must be pressed and held in the mid position to move the robot.

Freedrive on robot

You can configure the Freedrive input to enable and use Freedrive without pressing the Freedrive button on a standard TP, or without having to press-and-hold any of the buttons on the 3PE TP in the light-press position. See [To use Freedrive on robot to freedrive the robot arm: on page 120](#).

Input Signals

Operational Mode

When defined, this input can be used to switch between **Automatic Mode** and **Manual Mode** (see [Operational mode on page 130](#)).

Safeguard Reset

When a Safeguard Stop occurs, this output ensures that the Safeguard Stop state continues until a reset is triggered.

Automatic Mode Safeguard Stop

Once configured, an **Automatic Mode Safeguard Stop** performs a Safeguard Stop when the input pins are low and ONLY when the robot is in Automatic mode.

Automatic Mode Safeguard Reset

When an Automatic Mode Safeguard Stop occurs, the robot remains safeguard stopped in Automatic Mode until a rising edge on the input pins trigger a reset.



WARNING

- If you disable the default Safeguard Reset input, the Robot Arm is no longer Safeguard Stop stopped as soon as the input is high. A program paused only by the Safeguard stop resumes.
- Similar to the Safeguard Reset, if the default Automatic Mode Safeguard Reset is disabled, the Robot Arm is no longer Safeguard Stop stopped once the Automatic Mode Safeguard Stop input is high. A program paused only by the Automatic Mode Safeguard Stop resumes.

Output Signals

You can apply the following Safety functions for output signals. All signals return to low when the state which triggered the high signal has ended:

System Emergency Stop

Signal is *Low* when the safety system has been triggered into an Emergency Stopped state by the Robot Emergency Stop input or the Emergency Stop Button. To avoid deadlocks, if the Emergency Stopped state is triggered by the System Emergency Stop input, low signal will not be given.

Robot Moving

Signal is *Low* if the robot is moving, otherwise high.

Robot Not Stopping

Signal is *High* when the robot is stopped or in the process of stopping due to an emergency stop or safeguard stop. Otherwise it will be logic low.

Reduced

Signal is *Low* when the robot arm uses reduced parameters or if the safety input is configured with a reduced input and the signal is currently low. Otherwise the signal is high.

Not Reduced

This is the inverse of Reduced, defined above.

Safe Home

Signal is *High* if the Robot Arm is stopped in the configured Safe Home Position. Otherwise, the signal is *Low*.



NOTICE

Any external machinery receiving its Emergency Stop state from the robot through the System Emergency Stop output must comply with ISO 13850. This is particularly necessary in setups where the Robot Emergency Stop input is connected to an external Emergency Stop device. In such cases, the System Emergency Stop output becomes high when the external Emergency Stop device is released. This implies that the emergency stop state at the external machinery will be reset with no manual action needed from the robot's operator. Hence, to comply with safety standards, the external machinery must require manual action in order to resume.

OSSD Safety Signals

You can configure the Control Box to output OSSD pulses when a safety output is inactive/high. OSSD pulses detect the ability of the Control Box to make safety outputs active/low. When OSSD pulses are enabled for an output, a 1ms low pulse is generated on the safety output once every 32ms. The safety system detects when an output is connected to a supply and shuts down the robot.

The illustration below shows: the time between pulses on a channel (32ms), the pulse length (1ms) and the time from a pulse on one channel to a pulse on the other channel (18ms)

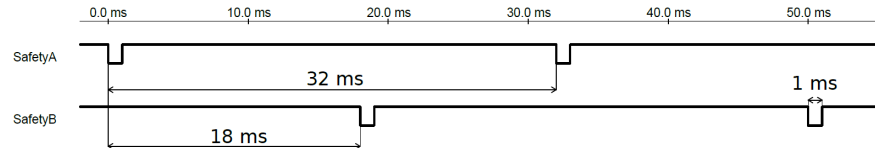

To enable OSSD for Safety Output

1. In the Header, tap **Installation** and select **Safety**.
2. Under **Safety**, select **I/O**.
3. On the I/O screen, under Output Signal, select the desired OSSD checkbox. You must assign the output signal to enable the OSSD checkboxes.

17.8. Software Safety Restrictions

Description



NOTICE

Configuring planes is entirely based on features. We recommend you create and name all features before editing the safety configuration, as the robot is powered off once the Safety Tab has been unlocked and moving the robot will be impossible.

Safety planes restrict robot workspace. You can define up to eight safety planes, restricting the robot tool and elbow. You can also restrict elbow movement for each safety plane and disable by deselecting the checkbox. Before configuring safety planes, you must define a feature in the robot installation (see [20.4 I/O Setup on page 281](#)). The feature can then be copied into the safety plane screen and configured.



WARNING

Defining safety planes only limits the defined Tool spheres and elbow, not the overall limit for the robot arm. This means that specifying a safety plane, does not guarantee that other parts of the robot arm will obey this restriction.

Safety PlanesModes

You can configure each plane with restrictive **Modes** using the icons listed below.

Disabled

The safety plane is never active in this state.

Normal

When the safety system is in Normal mode, a normal plane is active and it acts as a strict limit on the position.

Reduced

When the safety system is in Reduced mode, a reduced mode plane is active and it acts as a strict limit on the position.

Normal & Reduced

When the safety system is either in Normal or Reduced mode, a normal and reduced mode plane is active and acts as a strict limit on the position.

Trigger Reduced Mode

The safety plane causes the safety system to switch to Reduced mode if the robot Tool or Elbow is positioned beyond it.

Show

Pressing this icon hides or shows the safety plane in the graphics pane.

Delete

Deletes the created safety plane. There is no undo/redo action. If a plane is deleted in error, it must be remade.

Rename

Pressing this icon allows you to rename the plane.

Configuring safety planes

1. In your PolyScope header, tap **Installation**.
 2. In the Side Menu on the left of the screen, tap Safety and select **Planes**.
 3. On the top right of the screen, in the Planes field, tap **Add plane**.
 4. On the bottom right of the screen, in the **Properties** field, set up Name, Copy Feature and Restrictions.
-

Copy Feature

In **Copy Feature**, only Undefined and Base are available. You can reset a configured safety plane by selecting **Undefined**

If the copied feature is modified in the Features screen, a warning icon appears to the right of the Copy Feature text. This indicates that the feature is out of sync i.e. the information in the properties card is not updated to reflect the modifications that may have been made to the Feature.

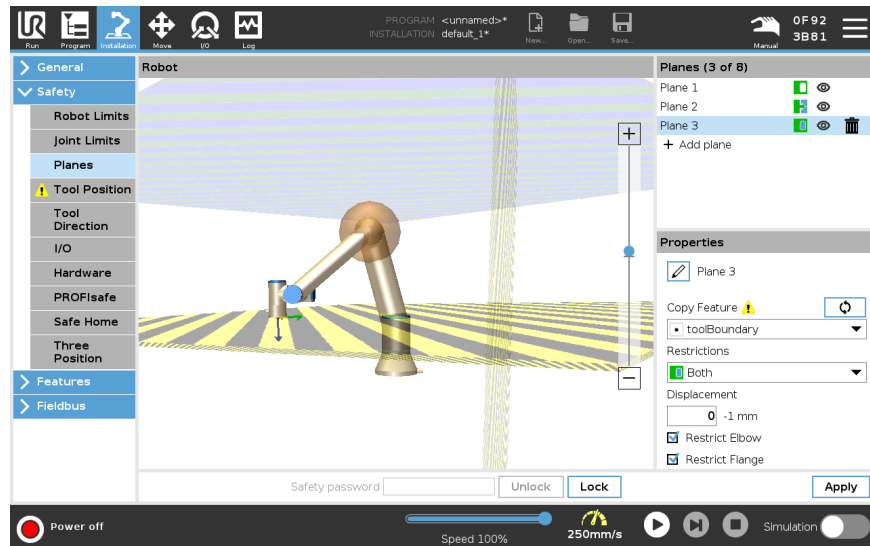

Color Codes

Gray

Plane is configured but disabled (A)

Yellow & Black

Normal Plane (B)

Blue & Green

Trigger Plane (C)

Black Arrow

The side of the plane the tool and/or elbow is allowed to be on (For Normal Planes)

Green Arrow

The side of the plane the tool and/or elbow is allowed to be on (For Trigger Planes)

Gray Arrow

The side of the plane the tool and/or elbow is allowed to be on (For Disabled Planes)

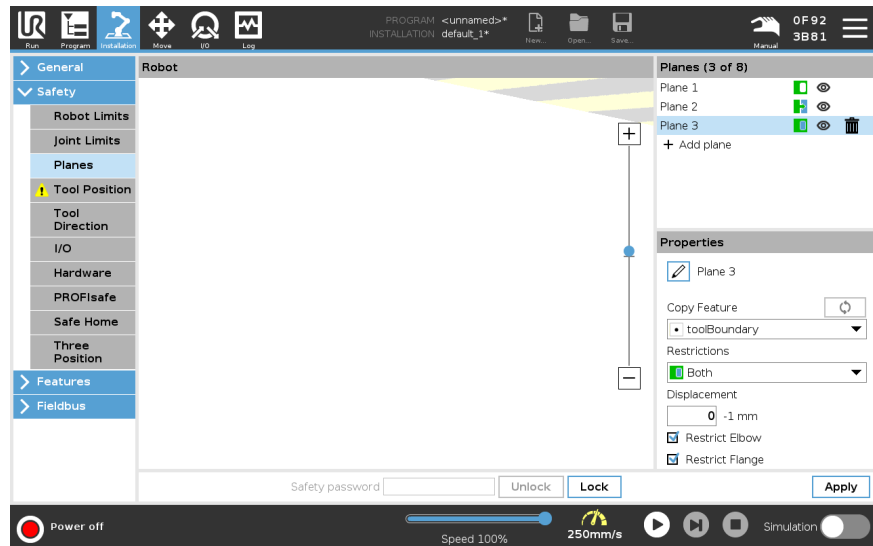

Elbow Restriction You can enable **Restrict Elbow** to prevent robot elbow joint from passing through any of your defined planes. Disable Restrict Elbow for elbow to pass through planes. The diameter of the ball that restricts the elbow is different for each size of robot.

UR3e	0.1 m
UR5e	0.13 m
UR10e / UR16e	0.15 m
UR20 / UR30	0.1891 m

The information about the specific radius can be found in the *urcontrol.conf* file on the robot under the section [Elbow].

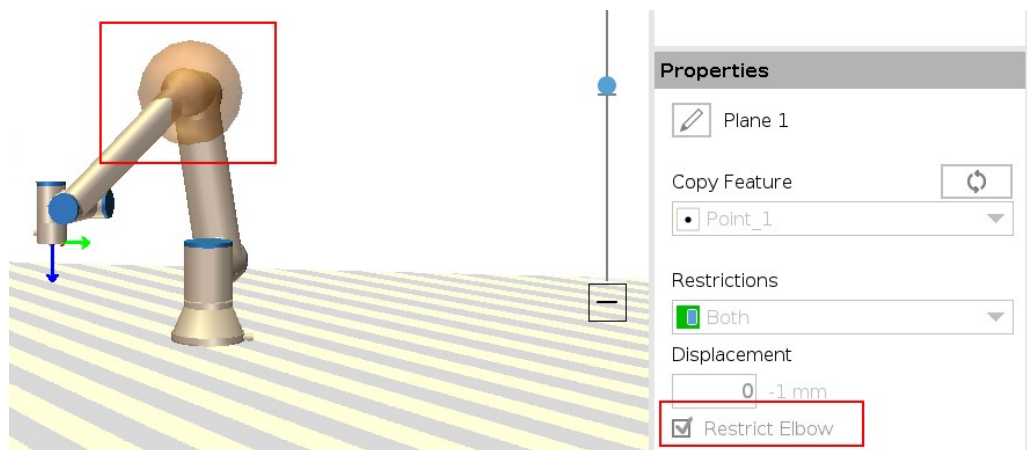

Tool Flange Restriction

Restricting the tool flange prevents the tool flange and the attached tool from crossing a safety plane. When you restrict the tool flange, the unrestricted area is the area inside of the safety plane, where the tool flange can operate normally. The tool flange cannot cross the restricted area, outside of the safety plane.

Removing the restriction allows the tool flange to go beyond the safety plane, to the restricted area, while the attached tool remains inside of the safety plane.

You can remove the tool flange restriction when working with a large tool off-set. This will allow extra distance for the tool to move.

Restricting the tool flange requires the creation of a plane feature. (See [20.13 Features on page 295](#)). The plane feature is used to set up a safety plane later in the safety settings.

Adding a plane feature example

Displacement offsets the plane in either the positive or negative direction along the plane normal (Z-axis of the plane feature). Deselect the checkbox for the Elbow and the Tool Flange so they do not trigger the safety plane. The Elbow can remain checked as needed by your application.

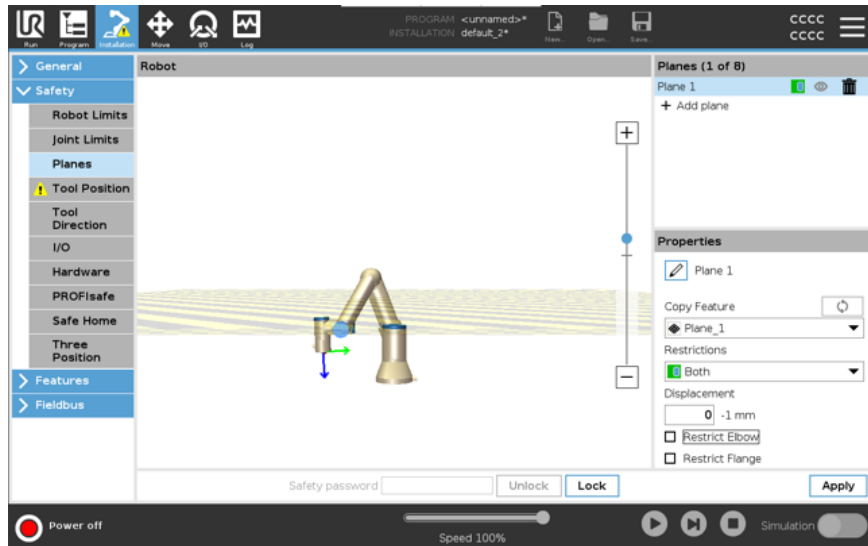

The unrestricted tool flange can cross a safety plane, even when no tool is defined. If no tool is added, a warning on the Tool Position button prompts you to correctly define the tool. When working with an unrestricted tool flange and a defined tool, it is ensured that the dangerous part of the tool can't go above and/or beyond certain area. The unrestricted tool flange can be used for any application where safety planes are needed, like Welding or Assembly.

Tool flange restriction example

In this example, an X-Y-plane is created with an offset of 300mm along the positive Z-axis with reference to the base feature.

The Z-axis of the plane can be thought of as “pointing” towards the restricted area.

If the safety plane is needed on e.g., the surface of a table, rotate the plane 3.142 rad or 180° around either the X- or Y-axis so the restricted area is under the table.

(TIP: Change the display of rotation from “Rotation Vector [rad]” to “RPY [°]”)

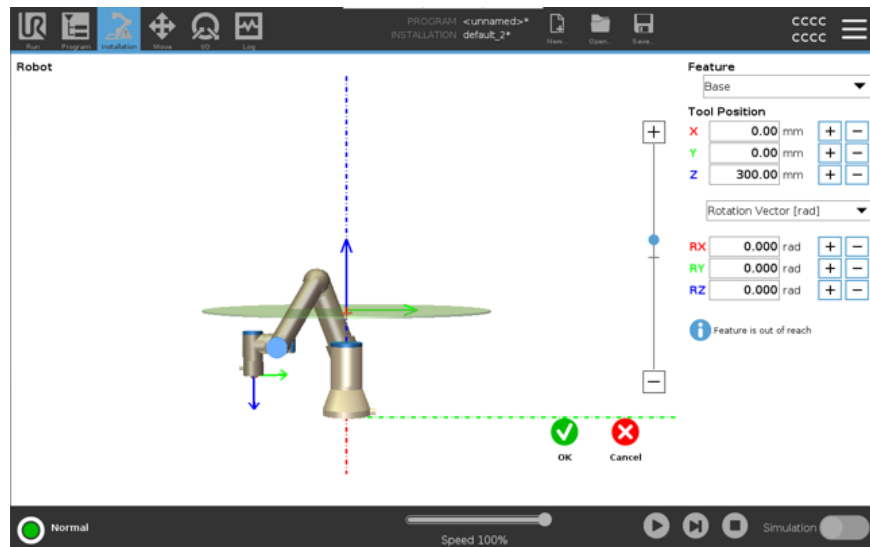

If needed it is possible to offset the plane in either positive or negative Z-direction later in the safety settings.

When satisfied with the position of the plane, tap OK.



17.8.1. Tool Direction Restriction

Description

The Tool Direction screen can be used to restrict the angle in which the tool is pointing. The limit is defined by a cone that has a fixed orientation with respect to the robot arm Base. As the robot arm moves around, tool direction is restricted so it remains within the defined cone. The default direction of the tool coincides with the Z-axis of the tool output flange. It can be customized by specifying tilt and pan angles. Before configuring the limit, you must define a point or plane in the robot installation. The feature can then be copied and its Z axis used as the center of the cone defining the limit.



NOTICE

Configuration of the tool direction is based on features. We recommend you create desired feature(s) before editing the safety configuration, as once the Safety Tab has been unlocked, the robot arm powers off making it impossible to define new features.

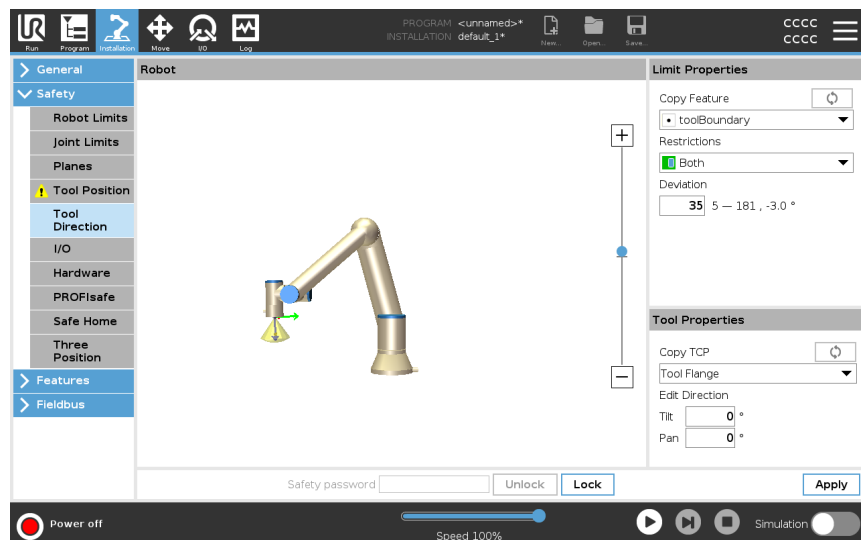

Limit Properties

The Tool Direction limit has three configurable properties:

1. **Cone center:** You can select a point or plane feature from the drop-down menu, to define the center of the cone. The Z axis of the selected feature is used as the direction around which the cone is centred.
2. **Cone angle:** You can define how many degrees the robot is allowed to deviate from center.

Disabled Tool direction limit
is never active

Normal Tool direction limit
is active only when safety system is in **Normal mode**.

Reduced Tool direction limit
is active only when the safety system is in **Reduced mode**.

Normal & Reduced Tool direction limit
is active when the safety system is in **Normal mode** as well as when it is in **Reduced mode**.

You can reset the values to default or undo the Tool Direction configuration by setting the copy feature back to "Undefined".

Tool Properties

By default, the tool points in the same direction as the Z axis of the tool output flange. This can be modified by specifying two angles:

- **Tilt angle:** How much to tilt the Z axis of the output flange towards the X axis of the output flange
- **Pan angle:** How much to rotate the tilted Z axis around the original output flange Z axis.

Alternatively, the Z axis of an existing TCP can be copied by selecting that TCP from the drop-down menu.

17.8.2. Tool Position Restriction

Description

The Tool Position screen enables more controlled restriction of tools and/or accessories placed on the end of the robot arm.

- **Robot** is where you can visualize your modifications.
- **Tool** is where you can define and configure a tool up to two tools.
- **Tool_1** is the default tool defined with values $x=0.0$, $y=0.0$, $z=0.0$ and $radius=0.0$. These values represent the robot tool flange.

Under Copy TCP, you can also select **Tool Flange** and cause the tool values to go back to 0.

A default sphere is defined at the tool flange.

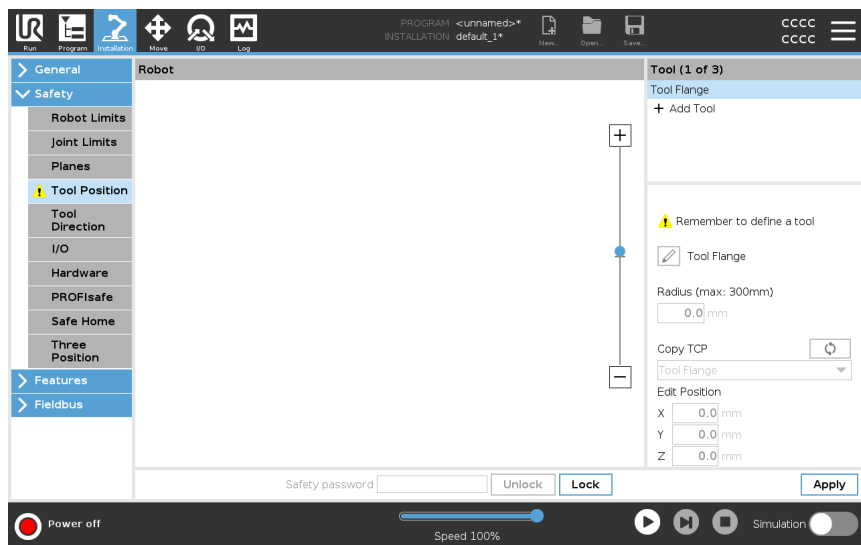

User defined tools

For the user defined tools, the user can change:

- **Radius** to change the radius of the tool sphere. The radius is considered when using safety planes. When a point in the sphere passes a reduced mode trigger plane, the robot switches to *Reduced* mode. The safety system prevents any point on the sphere from passing a safety plane (see [17.8 Software Safety Restrictions on page 149](#)).
- **Position** to change the position of the tool with respect to the tool flange of the robot. The position is considered for the safety functions for tool speed, tool force, stopping distance and safety planes.

You can use an existing Tool Center Point as a base for defining new tool positions. A copy of the existing TCP, predefined in General menu, in TCP screen, can be accessed in Tool Position menu, in Copy TCP drop-down list.

When you edit or adjust the values in the **Edit Position** input fields, the name of the TCP visible in the drop down menu changes to **custom**, indicating that there is a difference between the copied TCP and the actual limit input. The original TCP is still available in the drop down list and can be selected again to change the values back to the original position. The selection in the copy TCP drop down menu does not affect the tool name. Once you apply your Tool Position screen changes, if you try to modify the copied TCP in the TCP configuration screen, a warning icon appears to the right of the Copy TCP text. This indicates that the TCP is out of sync i.e. the information in the properties field is not updated to reflect modifications that may have been made to the TCP. The TCP can be synced by pressing the sync icon (see).

The TCP does not have to be synced in order to define and use a tool successfully.

You can rename the tool by pressing the pencil tab next to the displayed tool name. You can also determine the Radius with an allowed range of 0-300 mm. The limit appears in the graphics pane as either a point or a sphere depending on radius size.

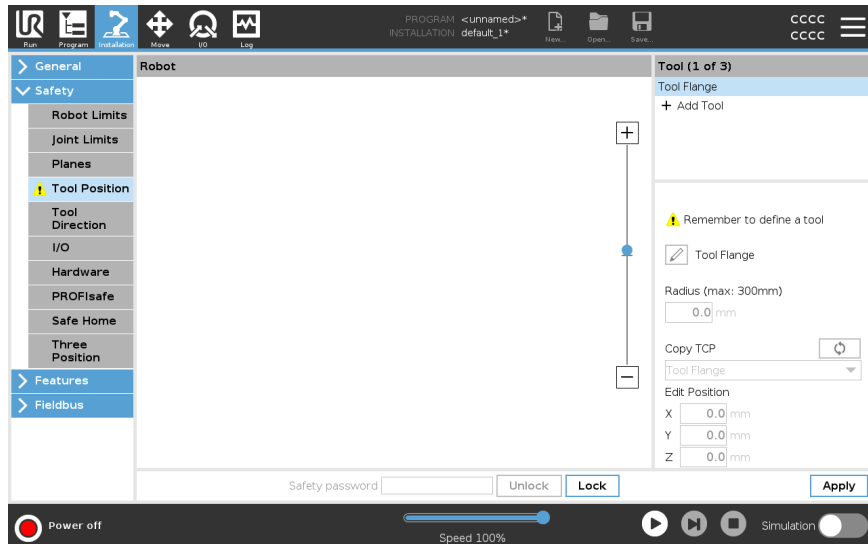

Tool Position Warning

You must set a Tool Position within the safety settings, for the safety plane to trigger correctly when the tool TCP approaches the safety plane.

The warning remains on the Tool Position if:

- You fail to add a new tool under Tool Flange.

To configure the tool position

1. In the Header tap **Installation**.
 2. On the left side of the screen, under Safety, tap **Tool Position**.
 3. On the right side of the screen, select **Add Tool**.
 - The newly added tool has a default name: **Tool_x**.
 4. Tap the edit button to rename **Tool_x** to something more identifiable.
 5. Edit the Radius and Position to match that of the tool you are currently using, or use the Copy TCP drop-down and choose a TCP from the General>TCP settings if such is defined.
-

**Tool Position
Warning example**

In this example, a Radius of 0.8mm is set and the TCP position to XYZ [20, 0, 400] in millimeters respectively. Optionally you can choose to "Copy TCP" by using the drop-down menu if one has already been set in the ->General/TCP settings. Once the Apply is tapped in the bottom right corner of the screen, you are DONE.

The warning on the Tool Position button indicates a tool is not added under Tool Flange.

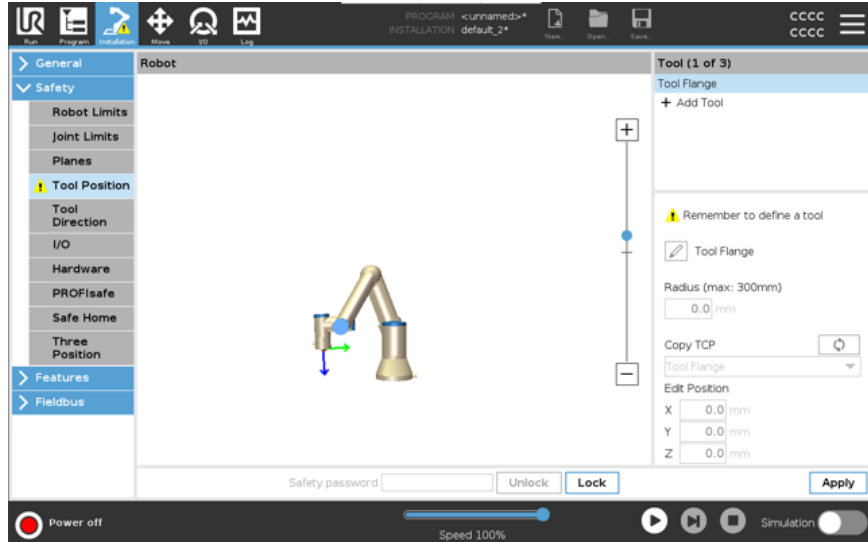

Tool Position button without the warning indicates a tool (other than the Tool Flange) is added.

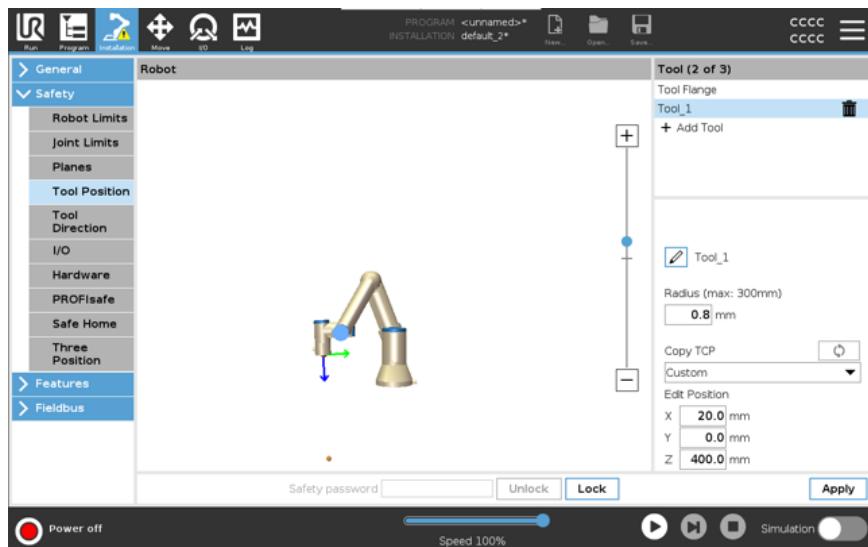

17.9. Safe Home Position

Description

Safe Home is a return position defined by using the user-defined Home Position. Safe Home I/Os are active when the Robot Arm is in the Safe Home Position and a Safe Home I/O is defined.

The Robot Arm is in the Safe Home Position if the joint positions are at the specified joint angles or a multiple of 360 degrees thereof.

The Safe Home Safety Output is active when the robot is standing still at the Safe Home Position.

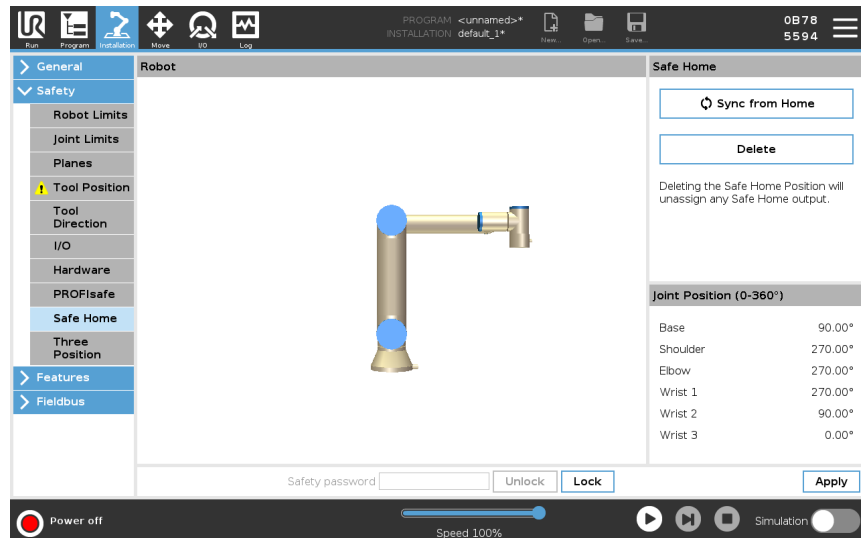

Syncing from Home

To sync from Home

1. In the Header, tap **Installation**.
2. In the Side Menu on the left of the screen, tap **Safety** and select **Safe Home**.
3. Under **Safe Home**, tap **Sync from Home**.
4. Tap **Apply** and in the dialog box that appears, select **Apply and restart**.

Safe Home Output

The Safe Home Position must be defined before the Safe Home Output (see [17.7 Safety I/O on page 145](#)).

Defining Safe Home Output

To define Safe Home Output

1. In the Header, tap **Installation**.
2. In the Side Menu on the left of the screen, under **Safety**, select **I/O**.
3. On the I/O screen in the Output Signal, under Function Assignment, in drop-down menu, select **Safe Home**.
4. Tap **Apply** and in the dialog box that appears, select **Apply and restart**.



Editing Safe Home

To edit Safe Home

Editing Home does not automatically modify a previously defined Safe Home position. While these values are out of sync, Home program node is undefined.

1. In the Header, tap **Installation**.
 2. In the Side Menu on the left of the screen, under **General**, select **Home**.
 3. Tap **Edit Position** and set the new robot arm position and tap **OK**.
 4. In the Side Menu, under **Safety**, select **Safe Home**. You need a Safety password to **Unlock** the Safety Settings (See [17.1 Setting a Software Safety Password on page 135](#)).
 5. Under **Safe Home**, tap **Sync from Home**
-

18. Run Tab

Description

The **Run** tab allows you to do simple operations and monitor the state of your robot. You can load, play, pause and stop a program, as well as monitor variables. The Run Tab is most useful when the program is created and the robot is ready for operation.

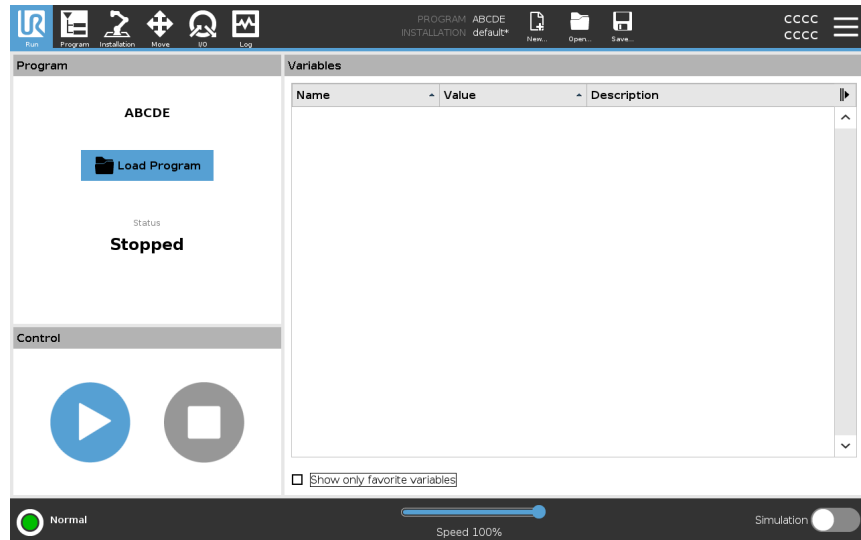

Program:

The Program pane displays the name and status of the current program.

Loading a new program

1. In the Program pane, tap **Load Program**.
2. Select your desired program from the list.
3. Tap **Open** to load the new program.

The variables, if present, are displayed when you play the program.

Variables:

The Variables pane display the list of variables. Variables are used by programs to store and update values during runtime.

- Program variables belong to programs.
- Installation variables belong to installations that can be shared among different programs. The same installation can be used with multiple programs.

All program variables and installation variables in your program are displayed in the Variables pane as a list showing the Name, Value and Description of the variable.

Variable descriptions

You can add information to your variables by adding variable descriptions in the Description column. You can use the variable descriptions to convey the purpose of the variable and/or the meaning of its value to operators using the Run tab screen and/or other programmers.

Variable descriptions (if used) can be up to 120 characters, displayed in the Description column of the variables list on the Run tab screen and the Variables tab screen.

Favorite variables

You can display selected variables by using the **Show only favorite variables** option. To show favorite variables

1. Under Variables, check the **Show only favorite variables** box.
2. Check **Show only favorite variables** again to show all variables.

You cannot designate favorite variables in the Run Tab, you can only display them. Designating favorite variables depends on the variable type.

See [19.2.4 Variables Tab on page 183](#) for more about program variables.

See [20.5 Installation Variables on page 284](#) for more about installation variables

Program variables

To designate favorite program variables

1. In the Header, tap **Program**.
The variables are listed under **Variable Setup**.
2. Select the desired variables.
3. Check the **Favorite variable** box.
4. Tap **Run** to return to your variable display.

Installation variables



To designate favorite installation variables

1. In the Header, tap **Installation**.
2. Under General, select **Variables**.
The variables are listed under **Installation Variables**.
3. Select the desired variables.
4. Check the **Favorite variable** box.
5. Tap **Run** to return to your variable display.

Collapse/expand the Description column

A variable description spans multiple lines to fit the width of the Description column if necessary. You can also collapse and expand the Description column by using the buttons shown below.

To collapse/expand the Description column

1. Tap  to collapse the Description column.
2. Tap  to expand the Description column.

Collapsed Description column

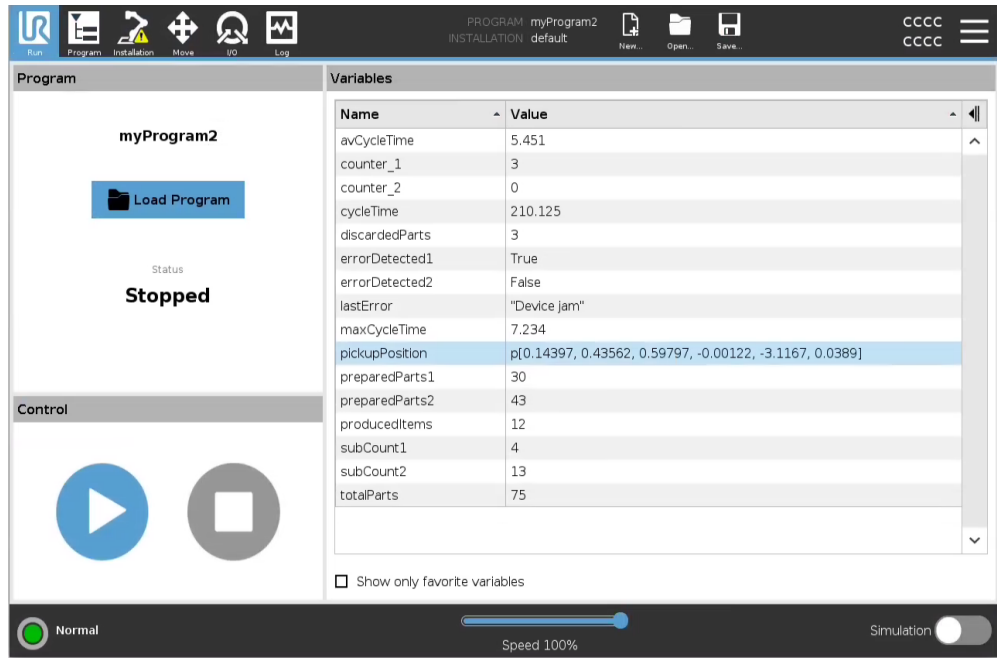

Expanded Description column

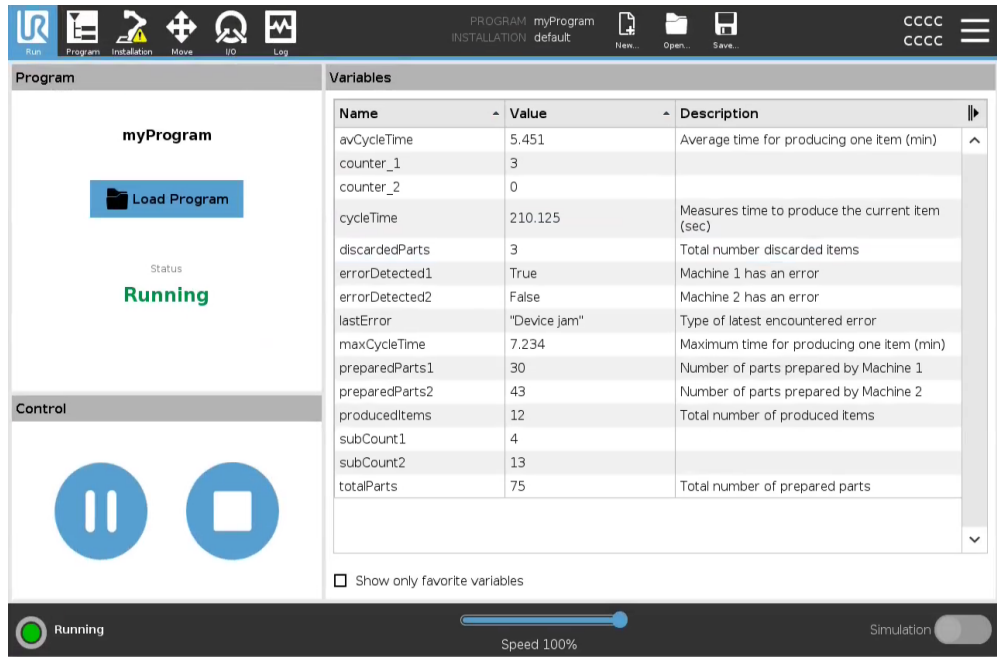





Control

The Control pane allows you to control the running program. You can play and stop, or pause and resume a program, using the buttons listed in the table below:

- The Play button, Pause button and the Resume Button are combined.
- The Play button changes to Pause when the program is running.
- The Pause button changes to Resume.

Button	Function
--------	----------

Copyright © 2009-2024 by Universal Robots A/S. All rights reserved.

Play		<p>To play a program</p> <ol style="list-style-type: none"> Under Control, tap Play to start running a program from the beginning.
Resume		<p>To resume a paused program</p> <ol style="list-style-type: none"> Tap Resume to continue running the paused program.
Stop		<p>To stop a program</p> <ol style="list-style-type: none"> Tap Stop to stop the running program <ul style="list-style-type: none"> You cannot resume a stopped program. You can tap Play to restart the program.
Pause		<p>To pause a program</p> <ol style="list-style-type: none"> Tap Pause to pause a program at a specific point. <ul style="list-style-type: none"> You can resume a paused program.

18.1. Move Robot into Position

Description Access the **Move Robot into Position** screen when the Robot Arm must move to a particular start position before running a program, or when the Robot Arm is moving to a waypoint while modifying a program.

In cases where the **Move Robot into Position** screen cannot move the Robot Arm to the program start position, it moves to the first waypoint in the program tree. The Robot Arm can move to an incorrect pose if:

- The TCP, feature pose or waypoint pose of the first movement is altered during program execution before the first move is executed.
- The first waypoint is inside an If or Switch program tree node.

- Accessing the Move Robot into Position Screen**
- Tap the Run tab in the header.
 - In the **Footer**, tap **Play** to access the **Move Robot into Position** screen.
 - Follow the on-screen instructions to interact with the animation and the real robot.

Move robot to Hold down **Move robot to:** to move the Robot Arm to a start position. The animated Robot Arm displayed on-screen shows the desired movement about to be performed.

**NOTICE**

Collision can damage the robot or other equipment. Compare the animation with the position of the real Robot Arm to ensure the Robot Arm can safely perform the movement without colliding with any obstacles.

Manual Tap **Manual** to access the **Move** screen where the Robot Arm can be moved by using the Move Tool arrows and/or configuring Tool Position and Joint Position coordinates.

18.2. Program

Description The **Program** field, displays the name of the program that was loaded on to the robot and its current status. You can tap the **Load Program** tab to load a different program.

18.3. Variables

Description A robot program can make use of variables to store and update various values during runtime. Two kinds of variables are available:

Installation variables

These can be used by multiple programs and their names and values are persisted together with the robot installation (see). Installation variables keep their value after the robot and control box has been rebooted.

Regular program variables

These are available to the running program only and their values are lost as soon as the program is stopped.

Show waypoints

The robot program uses script variables to store information about waypoints. Select the **Show Waypoints** checkbox, under **Variables** to show script variables in the variables list.

Variable types	<i>bool</i>	A boolean variable whose value is either <code>True</code> or <code>False</code> .
	<i>int</i>	A whole number in the range from <code>-2147483648</code> to <code>2147483647</code> (32 bit).
	<i>float</i>	A floating point number (decimal) (32 bit).

<i>string</i>	A sequence of characters.
<i>pose</i>	A vector describing the location and orientation in Cartesian space. It is a combination of a position vector (x, y, z) and a rotation vector (rx, ry, rz) representing the orientation, written $p[x, y, z, rx, ry, rz]$.
<i>list</i>	A sequence of variables.

19. Program Tab

Description

The Program tab is the where you create and edit robot programs

The Program tab consists of two main areas; the left side contains the program nodes you can add to your robot program, and the right side contains the configuration of the program nodes you can add to your program.

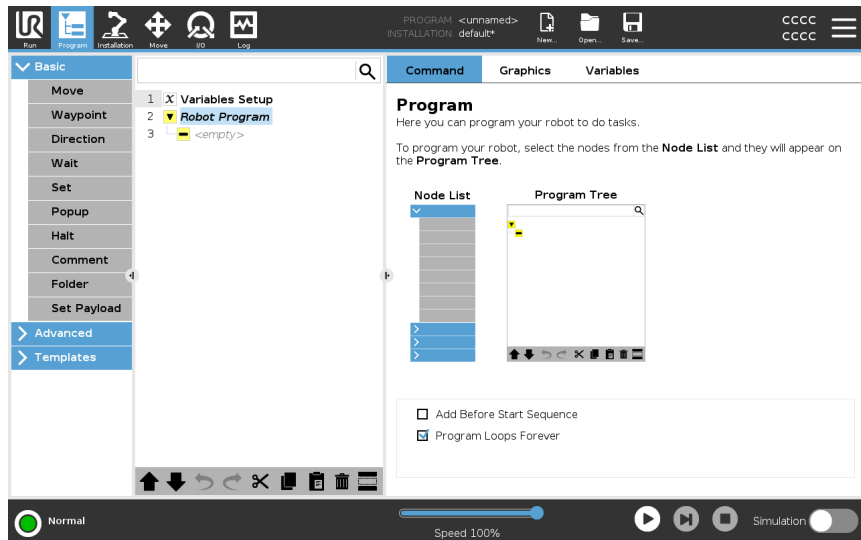

Program Tree

There are three tabs in the right side of the Program Tab. You can configure the functionality of the added program nodes on the Command tab.

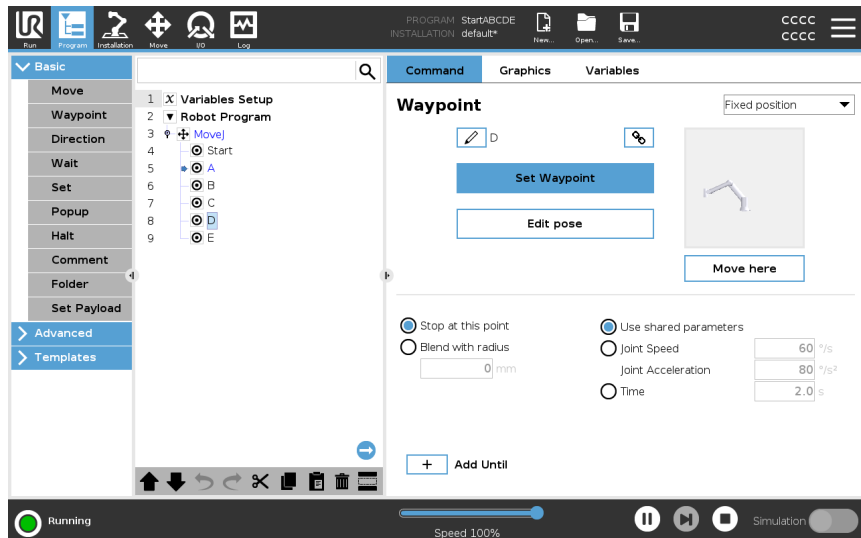

Note the following when adding program nodes:

- An empty program tree is not allowed to run.
- A program containing incorrectly configured program nodes is not allowed to run.
- Program nodes that are highlighted in yellow are not correctly configured.
- Program nodes that are highlighted in white are correctly configured.

Program Execution Indication

Robot programs often become quite long, so order to be able to see the flow of the robot program, you can look at what program node is active.

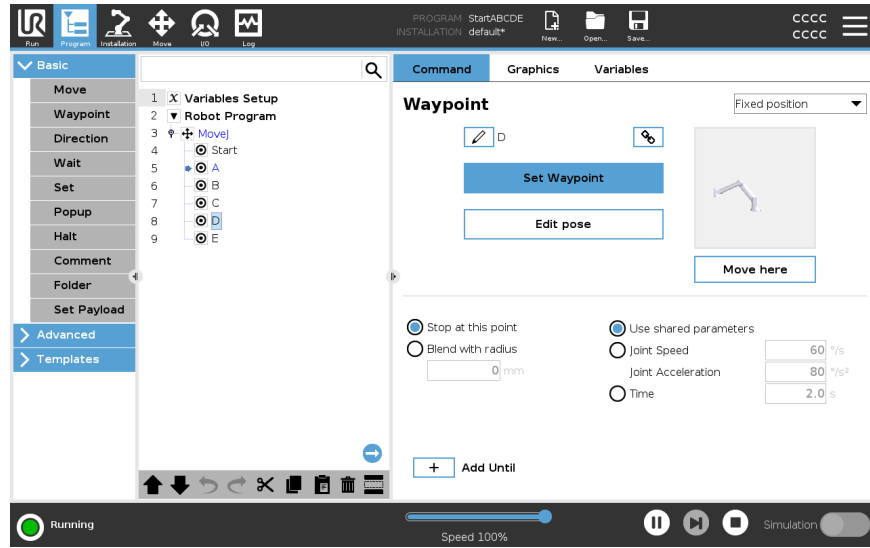

When the program is running, the program node currently being executed is indicated by a small icon next to that node.

The path of execution is highlighted in a blue. ➡

Pressing the icon at the corner of the program allows it to track the command being executed. ➡

Search Button

You can also search for a specific command/program node. This is useful when you have a long program with many different program nodes.

19.1. Robot Program Configuration

Description

It is possible to create a configuration for the entire robot program.

This type of configuration does not affect individual program nodes, it gives the entire robot program important behavior.

- You can add instructions to be executed before the robot program is started.
- You can set an initial variable value for the program start.
- You can make the program loop forever.

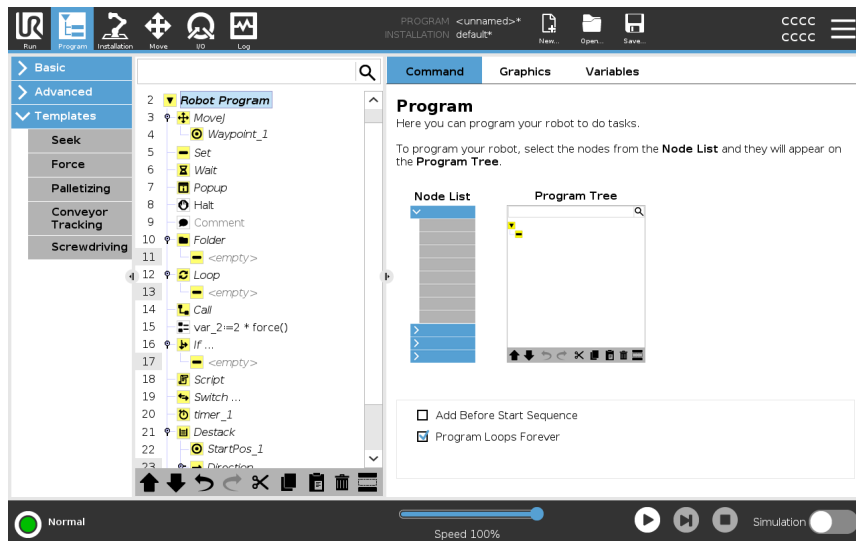

Add Before Start Sequence

Select this checkbox to add instructions or program nodes that are executed before the main program starts. These nodes are only executed once even though the robot program is set to loop forever.

Program Loops Forever

Select this checkbox to allow the program start again when it reaches the end of the program.

Example

This is for example where you initialize grippers, move the robot to a "home" position, or reset signals to and from external sources.



Set Initial Variable Value

Select this to set initial values of program variables.

1. Select a variable from the drop down list, or use the variable selector box.
2. Enter an expression for that variable. This expression is used to set the variable value at program start.
3. You can select **Keep value from previous run** to initialize the variable to the value found on the **Variables** tab (see [19.2.4 Variables Tab on page 183](#)). This allows variables to maintain their values between program executions. The variable gets its value from the expression if the program is run for the first time, or if the value tab has been cleared.

A variable can be deleted from the program by setting its name to blank (only spaces).









19.2. Program Tree Toolbar

Description

You can work with the program nodes that have been added to the program tree by using the icons in the bottom of the program tree.

Icons in the Program Tree toolbar

Use the toolbar at the base of the Program Tree to modify the Program Tree.

Undo & Redo	The  buttons serve to undo and redo changes to commands.
Move Up & Move Down	The  buttons change the position of a node.
Cut	The  button cuts a node and allows it to be used for other actions (e.g., paste it on other place on the Program Tree).
Copy	The  button copies a node and allows it to be used for other actions (e.g., paste it on other place on the Program Tree).
Paste	The  button allows you to paste a node that was previously cut or copied.
Delete	The  button to remove a node from the Program Tree.
Suppress	The  button to suppress specific nodes on the Program Tree.
Search Button	Tap the  to search in the Program Tree. Tap the  icon to exit search.

19.2.1. Variable Setup

Description

The Variable Setup is always the first node on the program tree. The Variable Setup pane is where you name and edit program variables, and designate them as favorites. Designating a favorite variable displays it on the Variable pane in the Program tab screen and on the Run tab screen.

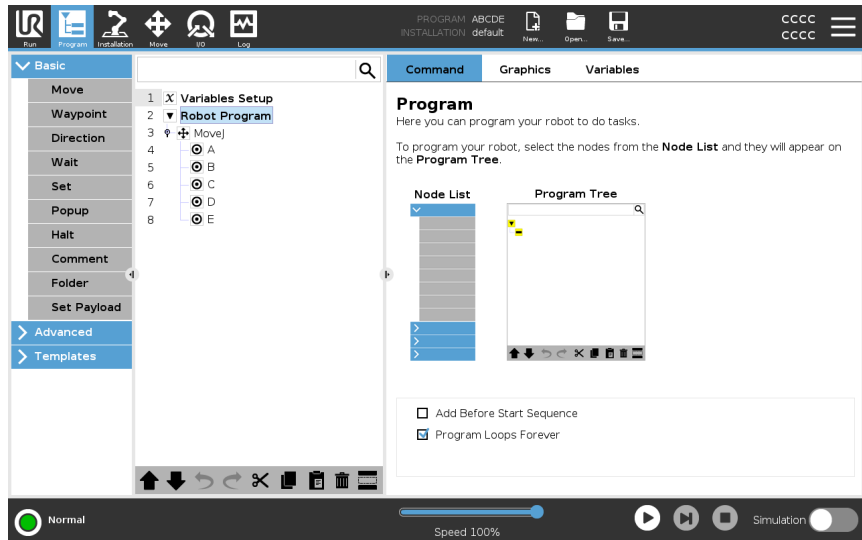

To designate a program variable as favorite

1. In the Header, tap **Program**.
2. Under Variables Setup, select a variable.
3. Check the **Favorite variable** box to designate the selected variable as favorite.

Editing program variables

Editing program variables includes naming, describing and setting an expression.

To name a program variable

1. Under Variables Setup, select a variable.
2. Select the **Name** field.
3. Type a name using the on-screen keyboard that appears.

To describe a program variable

1. Under Variables Setup, select a variable.
2. Select the **Description** field.
3. Type a description using the on-screen keyboard that appears.

To set an expression program variable

1. Under Variables Setup, select a variable.
2. Select the **Expression** field.
3. Type the expression using the on-screen keyboard that appears.

Initial value

An initial value is the first value you assign to a program variable, when you start a program.

You can check the **Keep value from previous run** box to replace the initial value with a value from a previously run program. However, if you load a new program, after using a value from a previously run program, the initial value is reinstated.

19.2.2. Command Tab

Description

The Command tab in the Program Tab contains the configuration options for the selected program node. These configuration options appear under the Command Tab on the right side of the screen. The Command tab's pane changes when you select each different program node, on the left side of the screen.

See examples of different commands below:

Move

The Move command is one of the most often used commands in PolyScope. Here you can see a MoveJ command is selected. Other information such as TCP, joint speed and joint acceleration is visible.

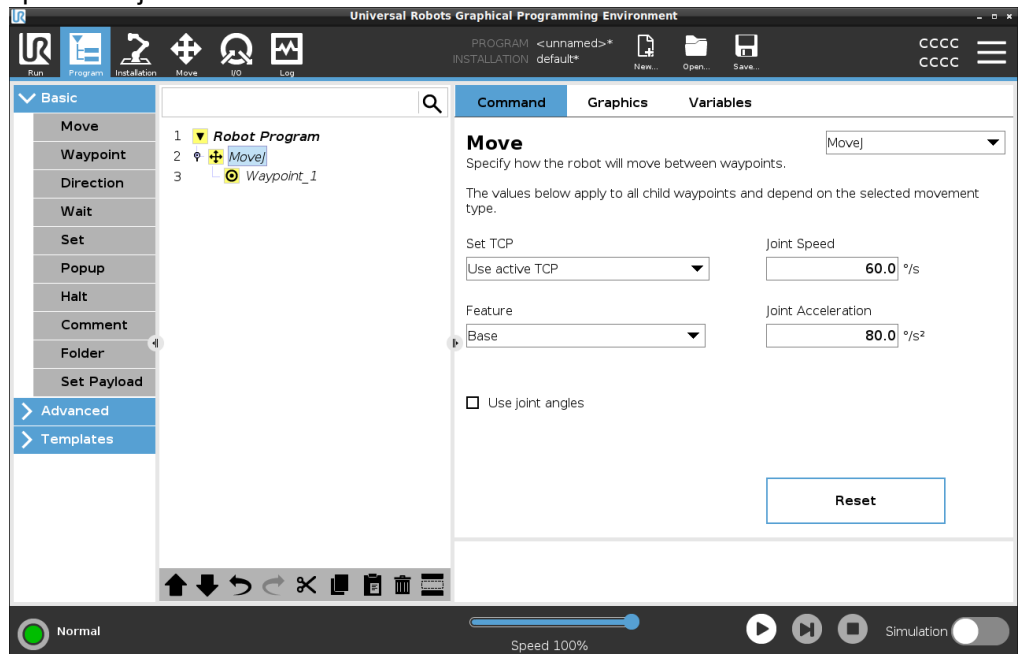

Example

The Movecommand controls the robot's motion via waypoints. You can also use Moves to set acceleration and speed for the robot arm's movement between waypoints.

Wait Command The Wait command is another often used program node.

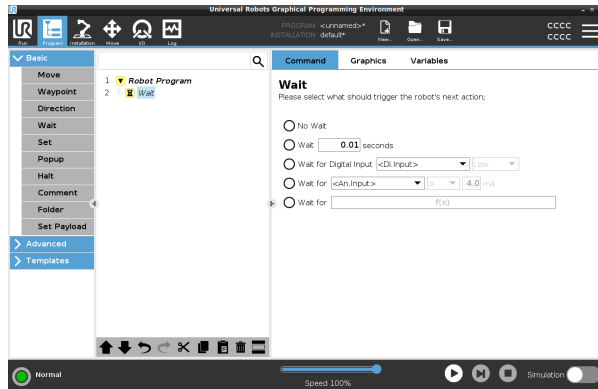

Example You can use the Wait command to make the robot program wait for a signal from a sensor that is attached to the control box.

Palletizing You can use the palletizing template to quickly create a palletizing program. The same palletizing program is also used to create a depalletizing program.

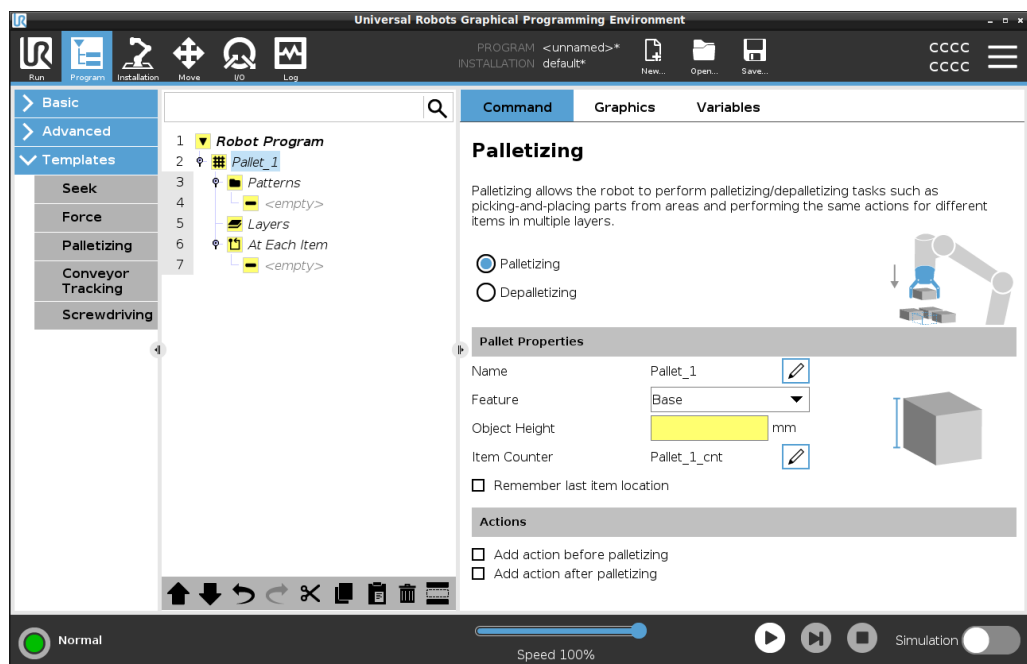

If You can add the If command the program tree to add "If", "Else" and "Elseif" conditions to a robot program.

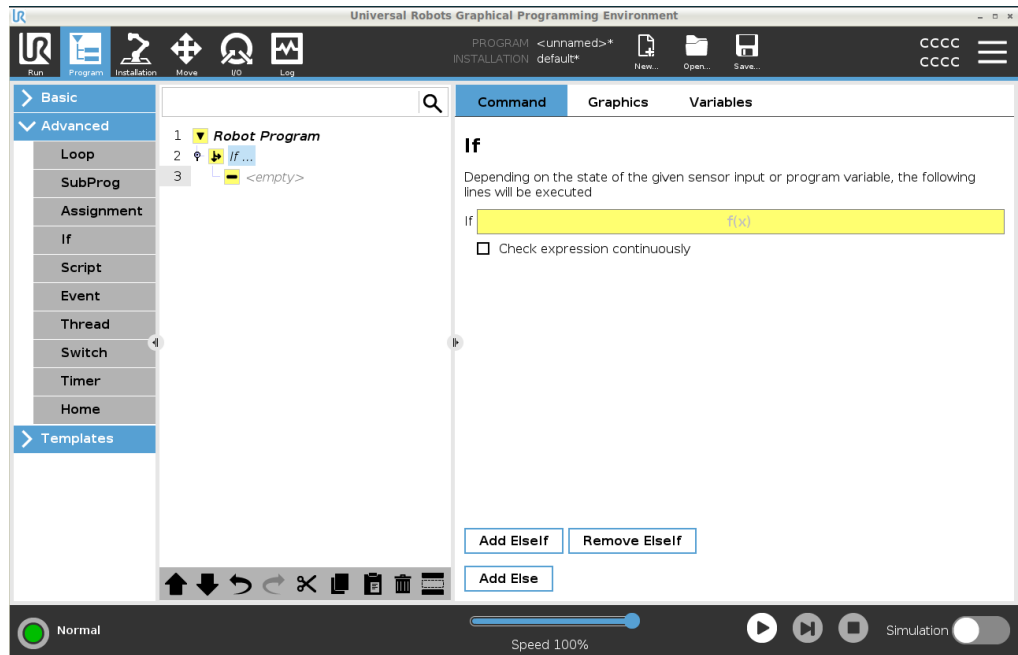

Example You can use the If command to create two different results for a robot program.

19.2.3. Graphics Tab

Description

The Graphics tab in the Program Tab provides a graphical representation of the running program.

The graphical representation appears in the pane under the Graphics tab on the right side of the screen.

The buttons in the top-right side of the pane can disable the various graphics in 3D view.

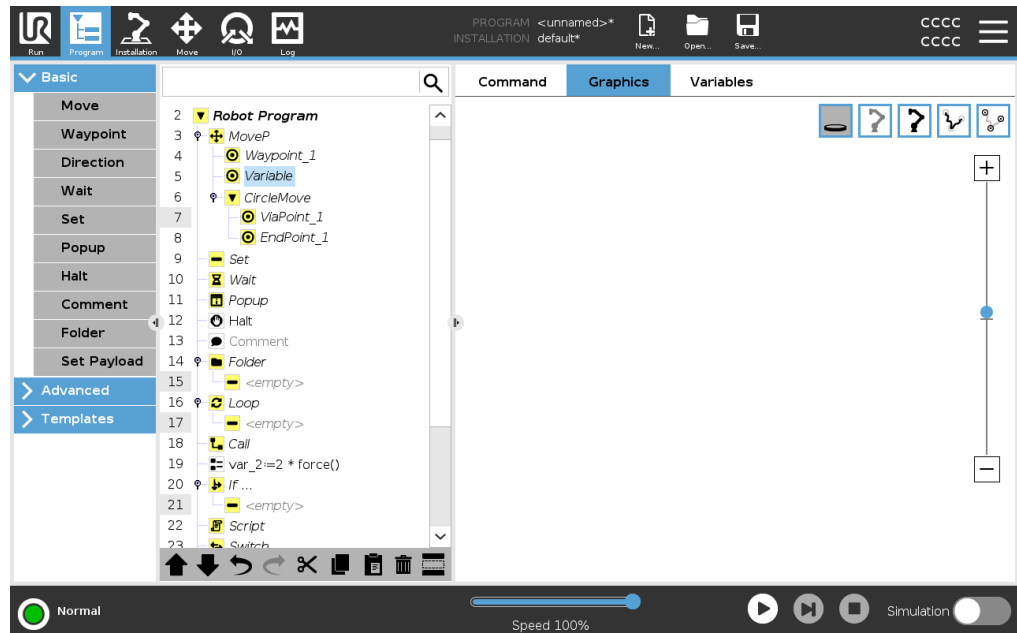

The 3D drawing of the robot arm shows the current position of the robot arm.

The shadow of the robot arm shows the robot arm's intended path to reach the waypoint selected in the left hand side of the screen.

The path of the TCP is shown in 3D view:

- The motion segments are black
- The blend segments (transitions between motion segments) are green.
- The green dots specify the positions of the TCP at each of the waypoints in the program.

Planes

A plane is a boundary that limits the movement of the TCP. A plane can also limit the movement of a tool.

A 3D representation of the plane appears in the pane when the TCP, or tool, comes close to a plane.

- You can zoom in to the 3D view to get a better view of the robot arm, TCP or tool.
- You can use two types planes to limit TCP and tool movement.

Safety Planes

Safety planes appear in the 3D view in yellow and black. A small arrow indicates the side of the plane where the TCP is allowed to be positioned.

Trigger Planes

Trigger planes appear in the 3D view in blue and green. A small arrow points to the side of the plane, where the Normal mode limits (see [17.5 Software Safety Modes on page 139](#)) are active.

The tool orientation boundary limit is visualized with a spherical cone together with a vector indicating the current orientation of the robot tool. The inside of the cone represents the allowed area for the tool orientation (vector).

Limits

When a program is running, the 3D view of boundary limits are disabled.

When the TCP is no longer close to any limit, the 3D view disappears.

- You can set tool orientation boundary limits that appear in the 3D view as a spherical cone together with a vector indicating the current orientation of the robot tool.

The inside of the cone represents the allowed area for the tool orientation (vector).

- You can also set red limits that appear red in the 3D view when the TCP is in violation, or very close to violating a boundary limit.
-

19.2.4. Variables Tab

Description

The Variables tab in the Program Tab shows the live values of variables in the running program. The variables appear as a list in the pane under the Variables tab on the right side of the screen. Variables only appear when there is information to display and remain visible between program runs.

Show Waypoints

You can check the Show Waypoints box to display the waypoint variables in the running program. In the Variables pane, you can also use the following options:

- Select **Show Waypoints** to show waypoint script variables in the variables list. The robot program uses script variables to store information about waypoints. Select the Show Waypoints checkbox, under Variables to show script variables in the variables list.
- Select **Show only favorite variables** to only view favorite variables on the Variables Tab. This is the same as in the Variables pane on the Run Tab (See [18 Run Tab on page 165](#)).

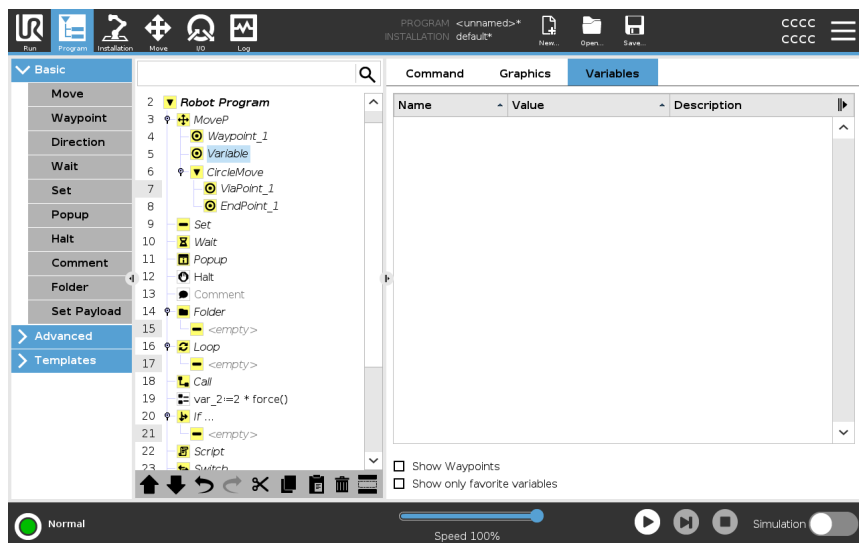

Variable Value Types

A robot program uses variables to store and update various values during runtime. Variables only appear when there is information to display. Variable types include:

- Program variables - These are available to the running program only and their values are lost as soon as the program is stopped.
- Installation variables - These can be used by multiple programs and their names and values stay together with the robot installation (see [20.5 Installation Variables on page 284](#)).
- Script variables - These come from script files and they can be assigned different variable types. Script variables do not appear in the Program tab or in the Installation tab. The robot program uses the script variables to store information about waypoints. You can select the Show Waypoints checkbox, under Variables, to show script variables in the variables list.

The table below list variable value types:

bool	A boolean variable whose value is either <code>True</code> or <code>False</code>
int	A whole number in the range from -2147483648 to 2147483647 (32 bit)
float	A floating point number (decimal) (32 bit)
string	A sequence of characters
pose	A vector describing the location and orientation in Cartesian space. It is a combination of a position vector (x, y, z) and a rotation vector (rx, ry, rz) representing the orientation written <code>p[x, y, z, rx, ry, rz]</code>
list	A sequence of variables

19.3. Expression Editor

Description

While the expression itself is edited as text, the expression editor has a number of buttons and functions for inserting the special expression symbols, such as `*` for multiplication and `≤` for less than or equal to. The keyboard symbol button in the top left of the screen switches to text-editing of the expression. All defined variables can be found in the `Variable` selector, while the names of the input and output ports can be found in the `Input` and `Output` selectors. Some special functions are found in `Function`.

Expressions in Editor

The expression is checked for grammatical errors when the **Ok** button is pressed. The **Cancel** button leaves the screen, discarding all changes.

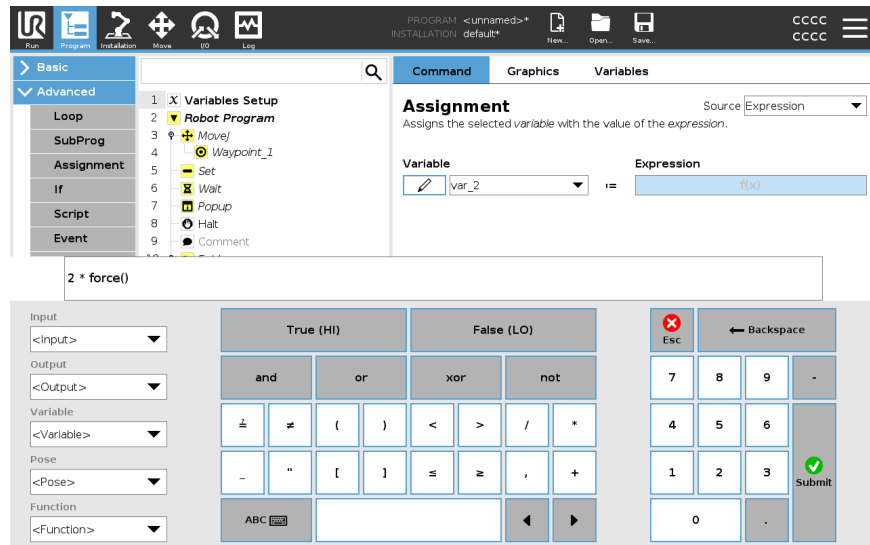

An expression can look like this:

```
digital_in[1]
```

```
?
```

```
True and analog_in[0]<0.5
```

19.4. Starting a Program from a Selected Program Node

Description

You can start your robot program from any program node in the program tree. This is useful when you are testing your program.

When the robot is in Manual Mode (see [Operational mode on page 130](#)), you can allow a program to start from a selected node or you can start the entire program from the beginning.

Play From Selection

The Play button in the Footer provides options for how to start the program. Here you can see the **Play** button is selected and the **Play from Selection** is displayed.

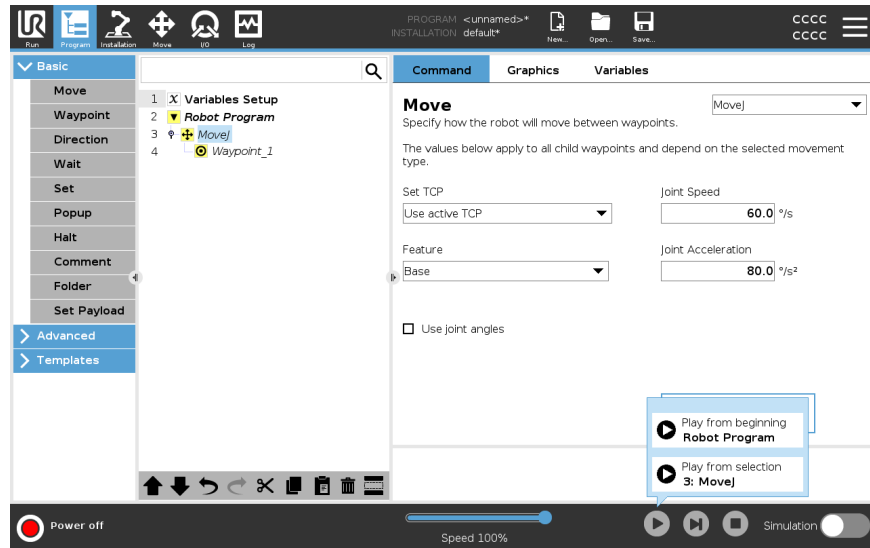

NOTICE

- A program can only start from a node in the robot Program tree.
- You can use **Play from Selection** in a subprogram. The program execution halts when the subprogram ends.
- The **Play from Selection** stops if a program cannot be run from a selected node.
- You cannot use **Play from Selection** with a thread because threads always start from the beginning.
- The program stops and displays an error message if an unassigned variable is encountered while playing a program from selected node.

Steps

To play a program from a selected node

1. In the program tree, select a node.
2. In the Footer, tap **Play**.
3. Select **Play from Selection** to run a program from a node in the program tree.

Example

If you had to stop the robot in the middle of a robot program, you can start the program again from a specific node.

19.5. Using Breakpoints in a Program

Description

A breakpoint pauses program execution. You can use breakpoints to pause and resume a running program at a specific point. This is useful when you are inspecting robot position, variables, etc. (See [Operational mode on page 130](#)).

Here you can see a breakpoint added to a node:

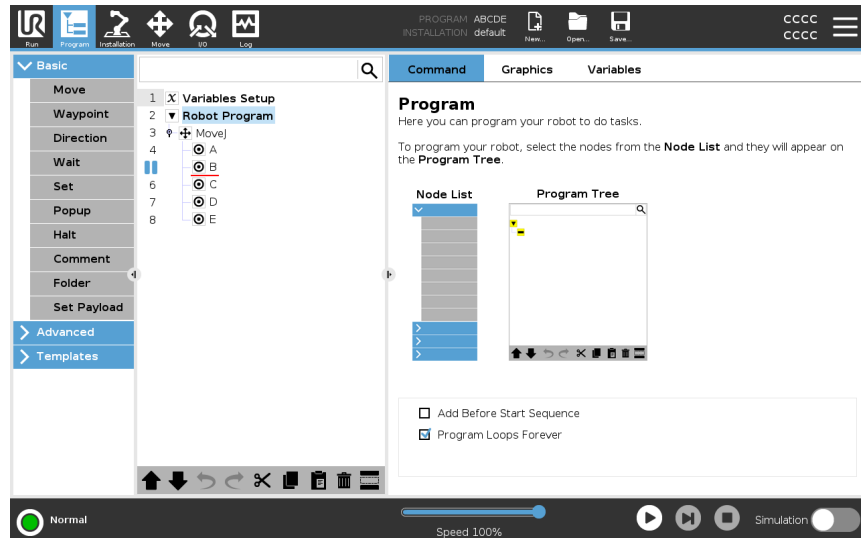

When the robot program reaches a breakpoint, it will turn red, and other upcoming breakpoints are still blue.

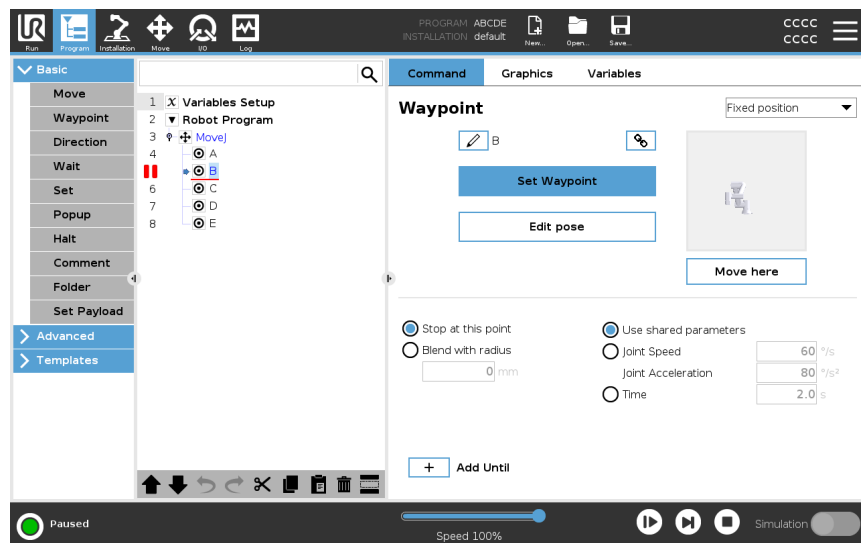

Breakpoints

The breakpoint appears as a red line either above or below a node. The red line appears below a waypoint nodes, and above other nodes.

Most nodes in program pause before they are executed. Adding a breakpoint changes the behavior of the nodes.

- You can add a breakpoint to a waypoint to allow the program to pause at this waypoint. This means the blend in the node is ignored.
- You can add a breakpoint to an Until node to allow the program to pause when the Until condition is met. This means the blend in the node is not ignored.



Add a Breakpoint To add a breakpoint to a program

1. In a Program tree, tap a line number to add a breakpoint.
2. The breakpoint is active until you clear the breakpoint from the robot program.

Clear a Breakpoint To clear a breakpoint in a program

1. In a Program tree, tap a breakpoint to remove it again.
 2. The robot program will run as intended.
-

19.6. Single Step in a Program

Description

Single Step allows the current program to be executed one node at a time, when the robot is in Manual mode.

(See [Operational mode on page 130](#)).

This is useful when you are checking your program for errors.

Single Step

Single Step allows the selected program node to run, then pauses at the beginning of a new node.

Single Step can only be used when the current program is paused.

If you want to use Single Step on a specific node, the node must also support Breakpoints.



19.7. Basic program nodes

Description

Basic program nodes are used to create simple robot applications. Some basic program nodes are also used to organize your robot program and create comments in your robot program. This can be quite useful, if it is large robot program.

19.7.1. Move

Description

The Move command allows the robot to move from point A to point B. How the robot moves is important to the task the robot is performing.

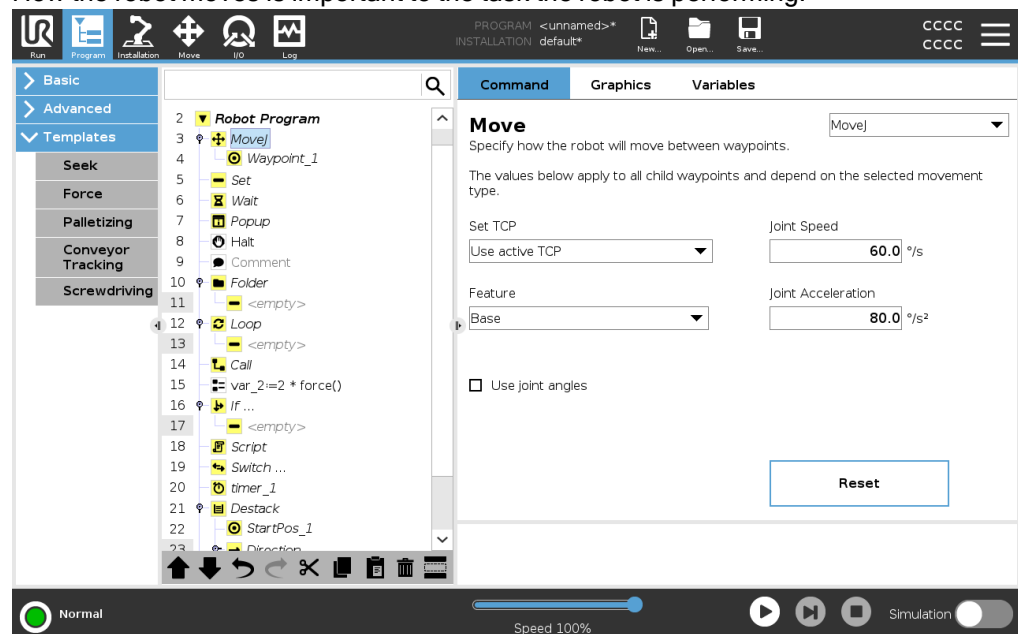

When you add a Move to your program tree, the Move pane appears to the right of the screen.

The Movecommand controls the robot's motion via waypoints.

Waypoints are automatically added when you add Move commands to a program.

[Read more about Waypoints.](#)

You can also use Moves to set acceleration and speed for the robot arm's movement between waypoints.

The robot moves using four Move commands. See the Move command types below:

MoveJ

The MoveJ command creates a movement from point A to point B that is optimal for the robot.

The movement may not be a direct line between A and B, but optimal for the start position of the joints and the end position of the joints.

Add a MoveJ command

1. In your robot program, select the place where you wish to add a Move.
2. Under Basic, tap **Move** to add a waypoint to the robot program together with a Move node.
3. Select the move node.
4. Select the MoveJ in the drop-down menu.

Detail

MoveJ makes movements that are calculated in the robot arm joint space. Joints are controlled to finish their movements at the same time. This movement type results in a curved path for the tool to follow. The shared parameters that apply to this movement type are the maximum joint speed and joint acceleration, specified in *deg/s* and *deg/s²*, respectively. If it is desired to have the robot arm move fast between waypoints, disregarding the path of the tool between those waypoints, this movement type is the preferable choice.

MoveL

The MoveL command creates a movement that is a direct line from point A and point B.

Add a MoveL command

1. In your Robot Program, select the place where you wish to add a Move.
2. Under Basic, tap **Move** to add a waypoint to the robot program together with a Move node.
3. Select the move node.
4. Select the MoveL from the drop-down menu.

Detail

MoveL moves the Tool Center Point (TCP) linearly between waypoints. This means that each joint performs a more complicated motion to keep the tool on a straight line path. The shared parameters that can be set for this movement type are the desired tool speed and tool acceleration specified in *mm/s* and *mm/s²*, respectively, and also a feature.

MoveP

The MoveP command creates a movement with a constant speed between the waypoints. Blend between waypoints is enabled to ensure constant speed. (See [Blending on page 206](#)).

Add a MoveP command

1. In your Robot Program, select the place where you wish to add a Move.
2. Under Basic, tap **Move** to add a waypoint to the robot program together with the Move node.
3. Select the move node.
4. Select the MoveP from the drop-down menu.

Detail

MoveP moves the tool linearly with constant speed with circular blends, and is intended for some process operations, like gluing or dispensing. The size of the blend radius is by default a shared value between all the waypoints. A smaller value will make the path turn sharper whereas a higher value will make the path smoother. While the robot arm is moving through the waypoints with constant speed, the robot control box cannot wait for either an I/O operation or an operator action. Doing so might stop the robot arm's motion, or cause a robot stop.

MoveCircle

The MoveCircle command creates a circular movement, by creating a half circle. You can only add CircleMove via a MoveP command.

Add a MoveCircle command

1. In your Robot Program, select the place where you wish to add a Move.
2. Under Basic, tap **Move**.
A waypoint is added to the robot program together with the Move node.
3. Select the move node.
4. Select the MoveP from the drop-down menu.
5. Tap **Add circle move**
6. Select the orientation mode.

Detail

The robot starts the circular movement from its current position, or start point, and moves through a ViaPoint specified on the circular arc, to an EndPoint that completes the circular movement.

A mode is used to calculate tool orientation, through the circular arc.

The mode can be:

- Fixed: only the start point is used to define the tool orientation.
- Unconstrained: the start point transforms to the EndPoint to define tool orientation.

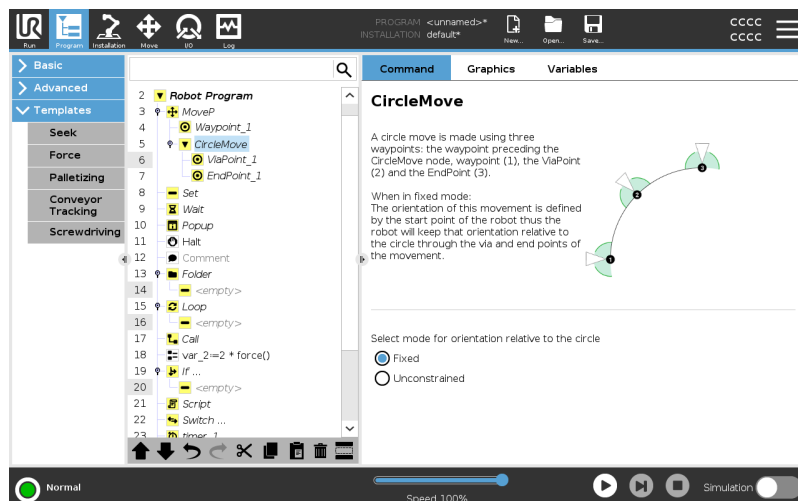

Move pane

Description The different feature options in the Move pane allow you to add detail to a Move and the attached waypoint/s.
Use these options to customize your program

See the Move pane features below:

Move: Set TCP Use this setting, if you need to change TCP during the robot program execution. This is useful if you need to manipulate different objects in the robot program.
The way the robot moves is adjusted depending on which TCP is set as an active TCP. **Ignore Active TCP** allows this movement to be adjusted in relation to the Tool Flange.

Set the TCP in a Move To set the TCP in a Move

1. Access the Program Tab screen to set the TCP used for waypoints.
2. Under Command, in the drop down menu on the right select the Move type.
3. Under Move, select an option in the **Set TCP** drop down menu.
4. Select **Use active TCP** or select a **user defined TCP**.
You can also choose **Ignore Active TCP**.

Move: Feature Feature is an option in the Move pane. Use Feature between waypoints for the program to remember the tool coordinates.
This is useful when you are setting the waypoints (see [20.13 Features on page 295](#)).

See the different Features below.

Feature You can use Feature in the following circumstances:

- Feature has no effect on relative waypoints. The relative movement is always performed with respect to orientation of the **Base**.
- When the robot arm moves to a variable waypoint, the Tool Center Point (TCP) is calculated as the coordinates of the variable in the space of the selected feature. Therefore, the robot arm movement for a variable waypoint changes if another feature is selected.
- You can change a feature's position while the program is running by assigning a pose to its corresponding variable.

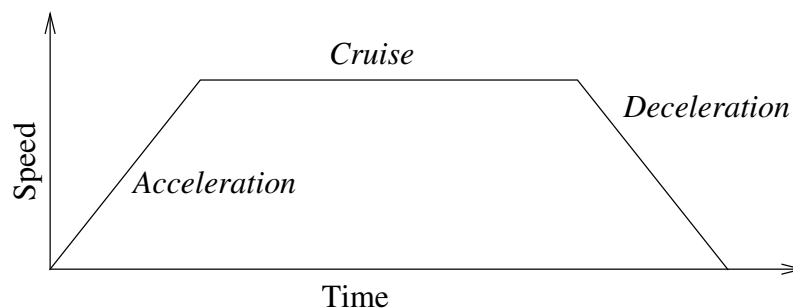

29.1: Speed profile for a motion. The curve is divided into three segments: acceleration, cruise and deceleration. The level of the cruise phase is given by the speed setting of the motion, while the steepness of the acceleration and deceleration phases is given by the acceleration parameter.

Move: Use joint angles

You can use the Use joint angles as an alternative to the 3D pose when you are using MoveJ to define a waypoint.

Waypoints defined using the Use joint angle are not changed when a program is moved between robots.

This is useful if you are installing your program in a new robot.

Using Use joint angles makes the TCP option unavailable.

Move: Shared Parameters in a Move Command

The shared parameters in the bottom right corner of the Move screen apply to the movement from the previous position of the robot arm to the first waypoint under the command, and from there to each of the following waypoints.

The Move command settings do not apply to the path going *from* the last waypoint under that Move command.

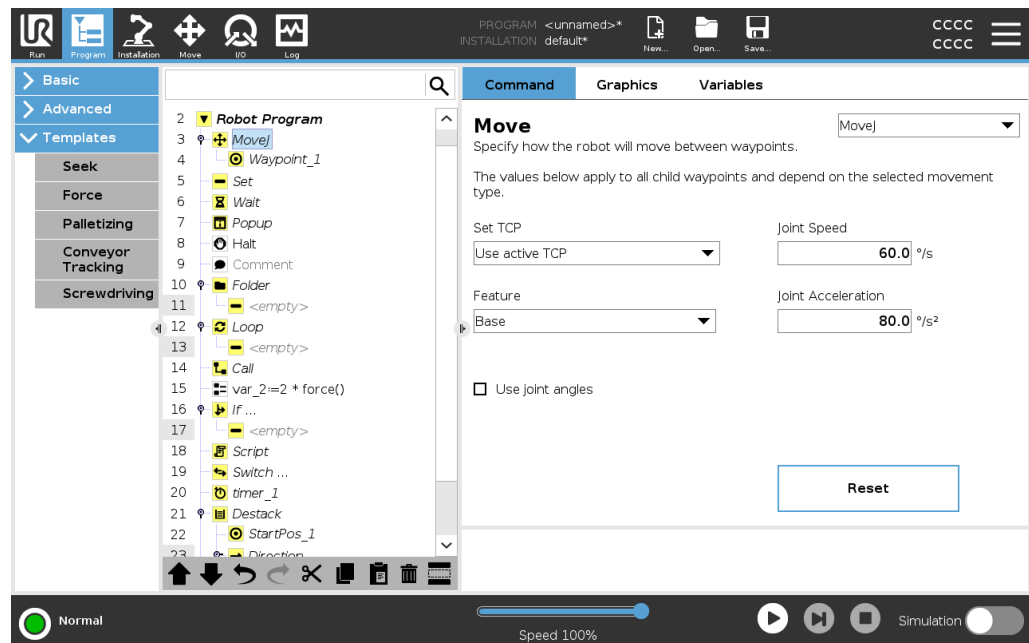

Copyright © 2009-2024 by Universal Robots A/S. All rights reserved.

19.7.2. Waypoints

Description

Waypoints are one of the most central parts of a robot program, telling the robot arm where to go one movement at a time.

Add Waypoints

A waypoint accompanies a Move, so adding a Move is required for the first waypoint.

Add a waypoint to a robot program

1. In your Robot Program, select the place where you wish to add a Move.
2. Under Basic, tap **Move**.

A waypoint is added to the robot program together with the Move node.

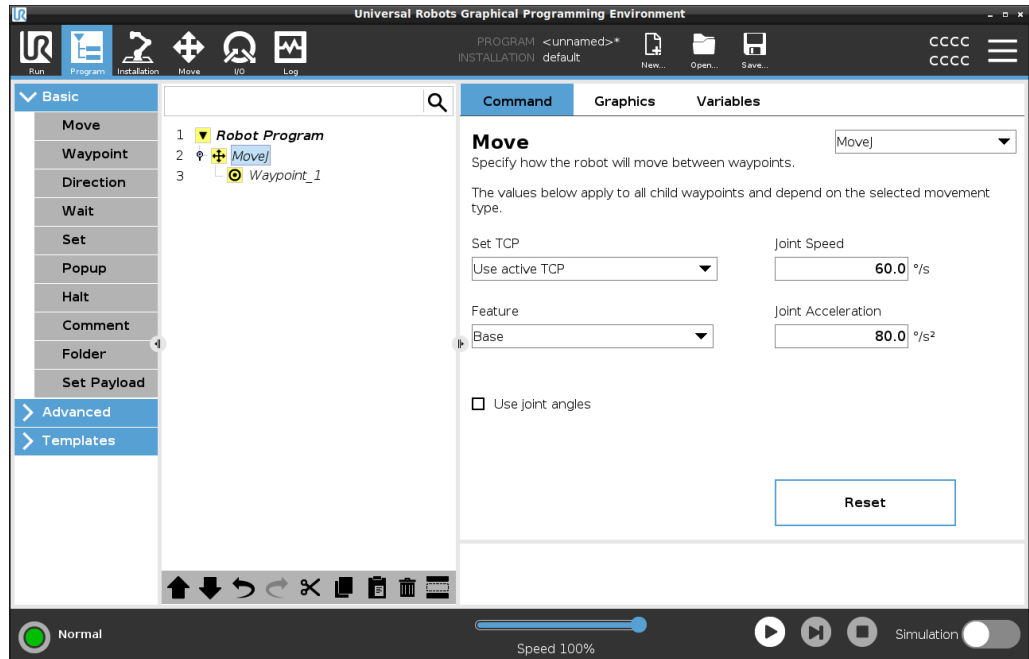

Add additional waypoints to a Move or Waypoint

1. In your Robot Program, select a Move node or Waypoint node.
2. Under Basic, tap **Waypoint**.

The additional waypoint is added in the Move node. This waypoint is part of the Move command.

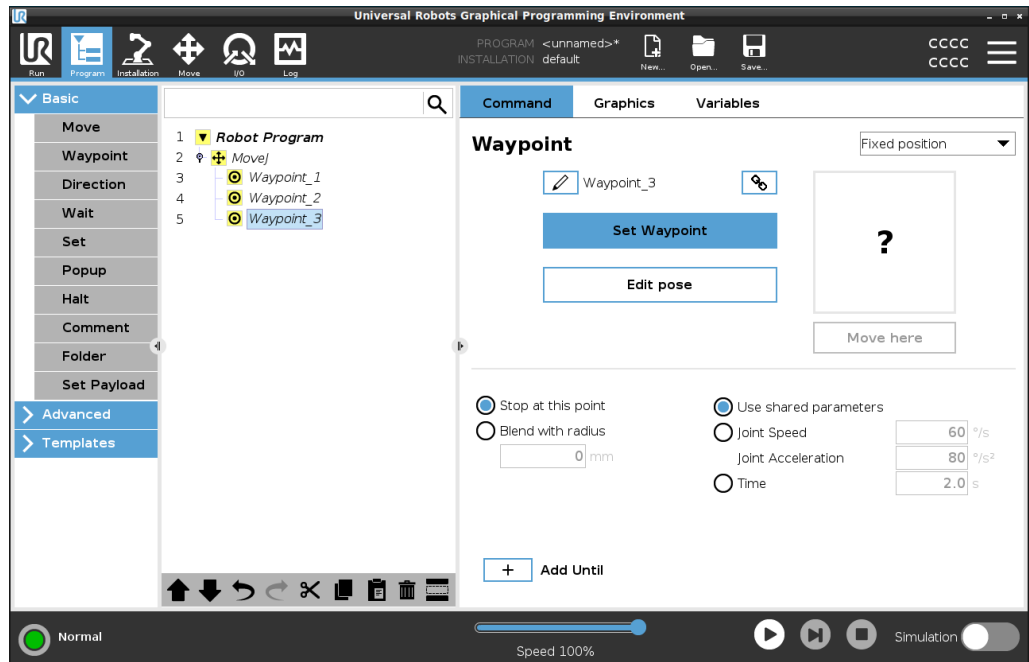

The additional waypoint is added under the waypoint that you selected in the robot program.

Detail Using a waypoint means applying the taught relationship between the feature and the TCP from the Move command. The relationship between the feature and the TCP, applied to the current selected feature, achieves the desired TCP location. The robot calculates how to position the arm to allow the current active TCP to reach the desired TCP position.

Configuring Waypoints

Description Waypoints can be configured in different ways depending on the setup, application and position of the waypoint in the robot program.

Naming Waypoints Waypoints automatically get a unique name when you add them to the robot program. The user can change the name of a waypoint.

- To name a waypoint**
1. Make sure you are positioned on the Command tab on the right side of the screen
 2. Select the waypoint you wish to rename
 3. Tap the **Rename** button 
 4. Type the new name
 5. Tap **Submit** to save the new name

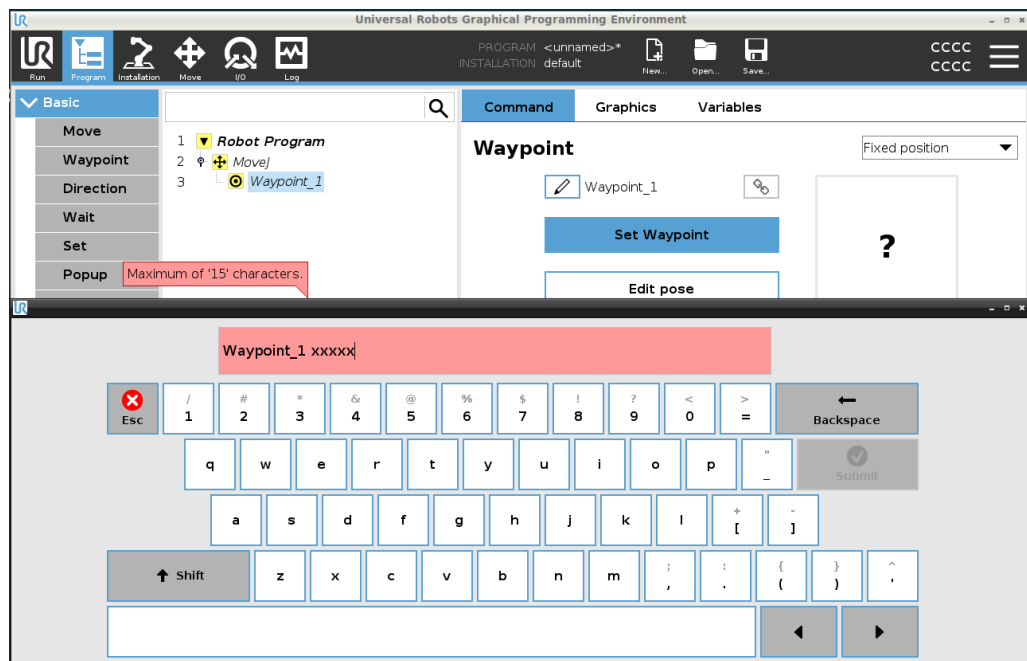

Tip In a large robot program, you can often have more than 50 waypoints, so create a naming rule that makes sense to you.



Linking Waypoints By selecting the link icon, waypoints are linked and share position information.

Detail Other waypoint information such as blend radius, tool/joint speed and tool/joint acceleration is configured for individual waypoints even though they may be linked.

Stop at this point You configure the robot program to stop at this waypoint. The robot will decelerate moving towards this point and continue to the next waypoint.

Use Stop at this point

1. Select the waypoint you wish to modify
2. On the right side of the screen, select  Stop at this point

Tip This is useful to make the robot move to an exact position.

Use case When you wish to move the robot away from a welding or machine tending application.

Blend with radius You can add a blend radius for blending the robot arm's movement between waypoints. [See this link for an in-depth description of blending.](#)

Use Blend with radius When you add a blend to a waypoint, the transition between waypoints becomes more fluid and efficient. This will make the robot arm move more smoothly, but it is not applicable in every robot arm movement.

1. Select the waypoint you wish to modify
2. On the right side of the screen, select  Blend with radius
3. Add a number [mm] to define the blend radius
4. Tap **Submit** to save the number

Tip If you are using multiple waypoints to guide the transition between two points you can blend the waypoints in between to make the overall movement smoother and more efficient.

Use Shared Parameters This is the default setting for the waypoint. The settings are copied from the parent Move command.

Use case This is used when the joint speed and joint acceleration is NOT changed in the parent Move command.

Joint Speed / Acceleration

You can modify the speed and acceleration of joints for each waypoint in a Move command.

Modify joint speed or acceleration

1. Select the waypoint you wish to modify
2. On the right side of the screen, set the joint speed or acceleration by selecting



Joint Acceleration

3. Add the value for speed
4. Add the value for acceleration

Use case

If you create a palletizing program, then you can make the waypoint move more slowly as the program places the objects, and move faster when moving to pick up another object.

Time

You can change the amount of time that it takes to reach this waypoint. The maximum is 21.600 seconds/6 hour.

Add time in seconds

1. Select the waypoint you wish to modify
2. On the right side of the screen, select
3. Add a number in [s]
4. Tap **Submit** to save the number

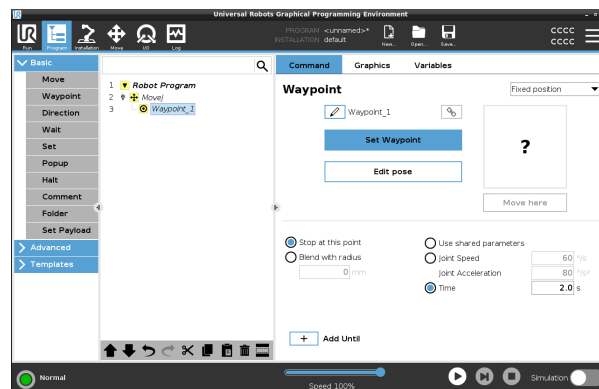

It now takes [s] to move the robot arm to this waypoint.

Add Until

Add Until will give you a number of different options for configuring your waypoint.

Steps

Please see the link [Add Until on page 213](#) for step by step instructions.

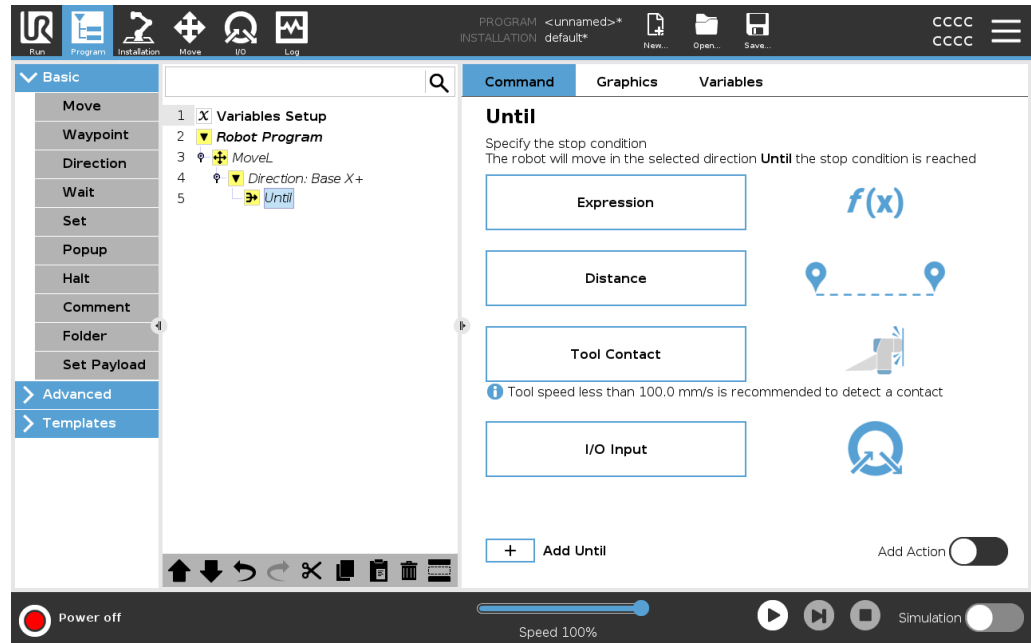

Copyright © 2009-2024 by Universal Robots A/S. All rights reserved.

Fixed Waypoint

Description

A fixed waypoint is the standard waypoint used in PolyScope. It is a fixed location, relative to a set coordinate system (the robot's base by default), that the robot will move back to when prompted. A fixed position waypoint is taught by physically moving the robot arm to the position. You can move the robot with the [16.4 Freedrive on page 119](#) or with the [21 Move Tab on page 314](#) in PolyScope.

When to use:

- If the robot must move to a specific location (to move around equipment or move to a specific location for operation like picking or placing).
- When you create an entire robot program using fixed waypoints relative to a location, i.e. relative to the robot base. You can move the robot, and redefine the location of base of the robot, then the robot program will work on the new location.

When NOT to use:

- When you want the location of the waypoint to be dynamic. Fixed waypoints are static positions and only change when purposely updated or when they're relative to a coordinate system.

Fixed Waypoint

You can add a fixed waypoint to your robot program, when you add a Move command. There is no difference, if the Move command is a MoveJ, a MoveL or a MoveP.

To add a fixed waypoint to a robot program

1. In the Program tab, tap Basic.
2. Add a move command
3. Select the automatically generated waypoint
 - a. Notice the selector is automatically set to

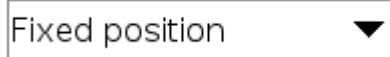

Set Waypoint

4. Tap  to access the Move tab
5. Set the waypoint



6. Tap the check mark to save the waypoint and return to the Program tab

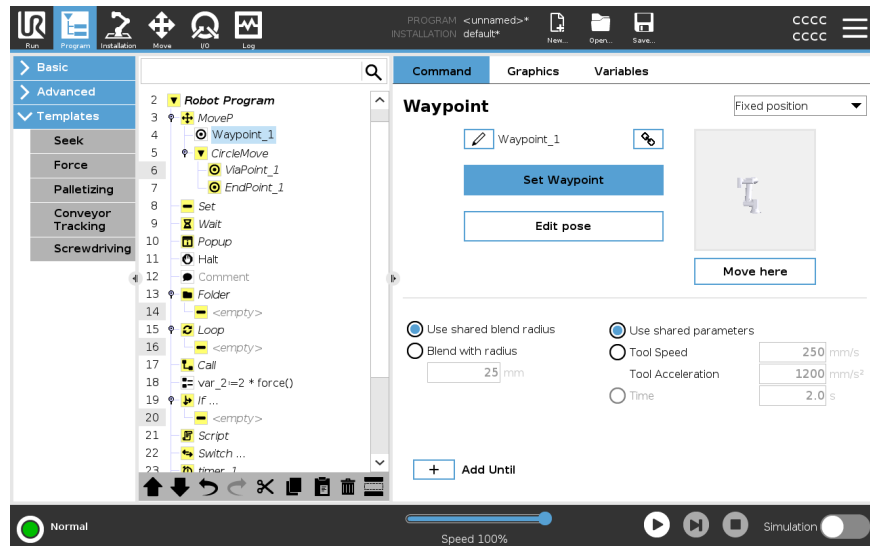

Example

When you are removing a work piece from a chuck in a machine tending application, make the waypoint a fixed position to avoid any contact with equipment.¹

Set Fixed Waypoint

Description

Setting a fixed waypoint means that you move the robot arm to the position of the specific waypoint that you want to set. Then the waypoint is "set" in the robot program as a position in the overall movement of the robot arm.

You can use the freedrive mode, or you can move the robot arm with the manual controls in the Move tab. See: [19.7.1 Move on page 191](#)

¹In machine tending, the chuck holds the tool performing work on a workpiece. For example, the chuck is the part of a drill that attaches to the drill bit.

Setting a Fixed Waypoint

To add a fixed waypoint to a robot program

1. In your Robot Program, select the place or node where you wish to add a fixed waypoint.
2. Under Basic, tap **Waypoint**.
3. Select your newly added waypoint in the robot program.

Set Waypoint

4. Tap

How you move the robot arm to set the waypoint depends very much on your robot program, the application what you are creating, the TCP configuration, etc. There is no one best way to set the waypoint.

- If you want to move the robot arm so that the TCP moves linearly, use the TCP arrows.
- If you want to move the robot arm with Freedrive, hold the Freedrive button.
- If you know the exact coordinate location for the next waypoint, then you can use the tool position to move the robot arm.
- If you want to move a specific joint, use the Joint Position values

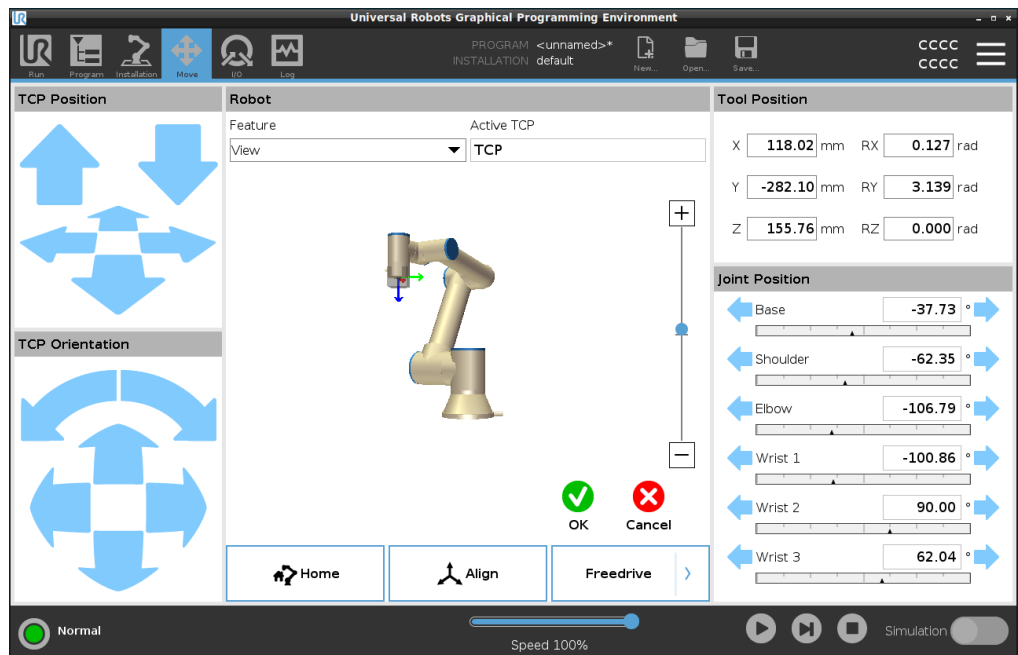

Relative Waypoint

Description

A relative waypoint is created by defining two waypoints. These two waypoints determine the distance and direction the relative waypoint should move. The relative waypoint can be defined to the robot arm's previous position, such as "two centimeters to the left". The second waypoint is dependent on the first. This waypoint can be created when adding the relative waypoint. It can also be a previously defined waypoint, such as a fixed waypoint.

When to use:

- When using a BeforeStart to move the robot straight up from any position. For example, if the robot is stopped in a position near parts.
- If the first waypoint is relative and you press play. You don't need to move the robot into position to start the program.
- When using SubPrograms to make repeatable movements at different locations around the robot. For example, screwdriving at multiple locations: move down 50mm, turn screwdriver on/off, move up 50mm.

When not to use:

- When a specific location must be reached repeatably.
- When a constant path is desired.

Example: Add relative waypoint

To move the robot 20 mm along the z-axis of the tool:

```
var_1=p[0,0,0.02,0,0,0]
Move1
Waypoint_1 (relative position):
Use variable=var_1, Feature=Tool
```

Add a relative waypoint to a robot program

1. In the Program tab, select the Basic menu
2. Tap **Waypoint**
 - a. Notice the selector is automatically set to Fixed position
 - b. Change the waypoint to Relative position.
3. Set the first waypoint (from point...)
4. Set the second waypoint (...to point)

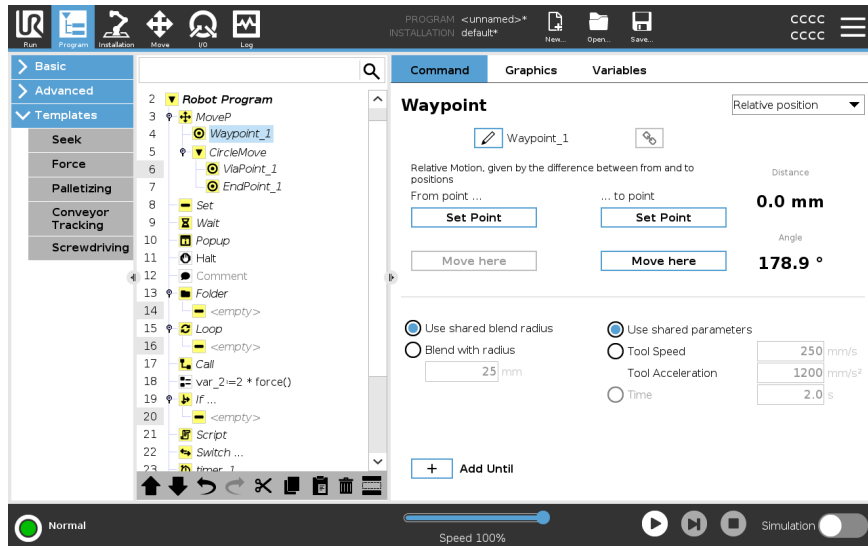

Detail

The movement between two relative waypoints is always the shortest path for the robot depending on the move type.

The distance for relative waypoints refers to the Cartesian distance between the TCP in the two positions. The angle states how much the TCP orientation changes between the two positions, or more precisely, the length of the rotation vector describing the change in orientation.

It does not matter where the relative waypoint position was located around the robot, before the program moved into the relative waypoint.

As soon as PolyScope moves to the relative waypoint in the program tree, the robot moves from its current position, to the distance and in the direction the relative waypoint has saved.

Repeated relative positions can move the robot arm out of its workspace.

Use Case: Welding and changing welding items

If you have a welding procedure, and you need to weld a seam around a rectangle, you can define the first corner with a fixed waypoint, and then make the robot and welding tool hit the remaining three corners using relative waypoints.

The first waypoint will start the welding seam around the rectangle, and the relative waypoints will finish the remaining corners.

Then if you need to weld something that is still a rectangle, but larger or smaller, then you can change the distance of the relative waypoints, and quickly modify the robot program.

Variable Waypoint

Description

A variable waypoint moves to a position determined by a variable in PolyScope. The variable must be in the pose URScript format, p[x, y, z, rx, ry, rz], allowing a single waypoint in the Program Tree to be updated by changing the X, Y, Z, RX, RY, or RZ value without manually resetting the waypoint.

When to use:

- If combined with scripting elements.
- When receiving data from external devices for positioning like cameras, etc.

When not to use:

- When a specific location must be reached repeatably.
- If you are not using variables or external devices.
- If a waypoint must be moved manually, or redefined by either jogging or freedrive.

Add a variable waypoint

Add a variable waypoint that can be modified during run through of the robot program.

Add a variable waypoint to a robot program

1. In the Program tab, hit the basic menu
2. Add a move command
3. Select the automatically generated waypoint
 - a. Notice that the selector is automatically set to Fixed position.
 - b. Change the selector to Variable position.
4. Select the variable from the drop-down menu.

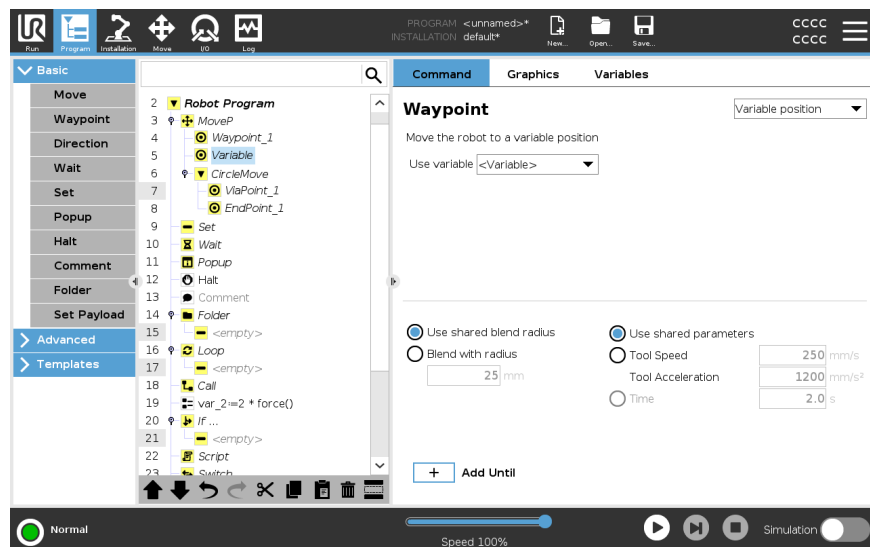

Detail

A waypoint with the position given by a variable, in this case *calculated_pose*.

The variable has to be a *pose* such as `var=p[0.5,0.0,0.0,3.14,0.0,0.0]`.

The first three are *x,y,z* and the last three are the orientation given as a *rotation vector* given by the vector *rx,ry,rz*.

The length of the axis is the angle to be rotated in radians, and the vector itself gives the axis about which to rotate.

The position is always given in relation to a reference frame or coordinate system, defined by the selected feature.

If a blend radius is set on a fixed waypoint and the waypoints preceding and succeeding it are variable or if the blend radius is set on a variable waypoint, then the blend radius will not be checked for overlap (see [Blending below](#)).

If, when running the program, the blend radius overlaps a point, the robot will ignore it and move to the next one.

Blending

Description

Blending enables the robot to smoothly transition between two trajectories, without stopping at the waypoint between them.

Blending makes your robot program run faster because, when you create a smooth transition between trajectories, you avoid slowing down an acceleration between trajectories.

See the following sections for additional information on blending:

- [Blend Parameters on the facing page](#)
 - [Blend Trajectories on page 210](#)
 - [Conditional Blend Trajectories on page 211](#)
-

**Example:
Blending in a pick
and place
application**

The robot starts at waypoint 1 (WP_1), and it needs to pick up an object at waypoint 3 (WP_3). To avoid collisions with the object and other obstacles, the robot must avoid (O) by using waypoint 2 (WP_2).

Three waypoints are introduced to create a path that fulfills the requirements.

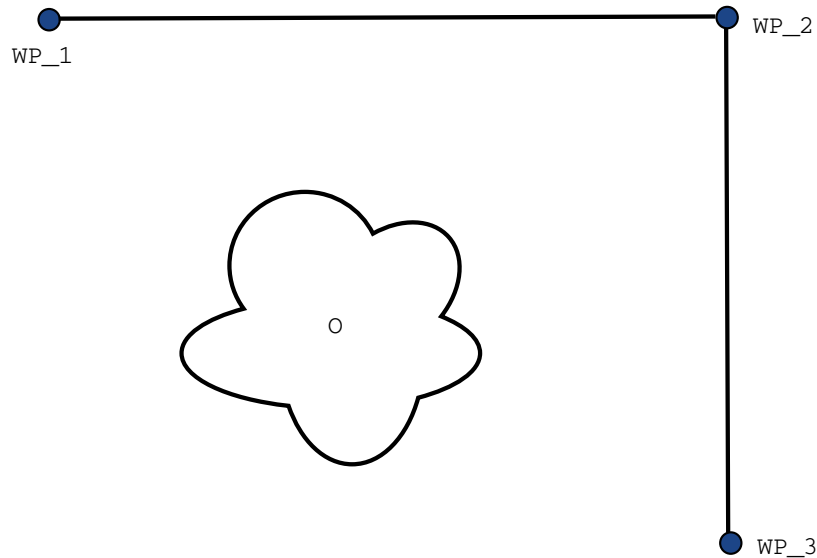

31.1: (WP_1): initial position, (WP_2): via point, (WP_3): pick up position, (O): obstacle.

Without configuring other settings, the robot will make a very brief but full stop at each waypoint, before continuing the movement.

For this task a stop at (WP_2) is not optimal since a smooth turn would require less time and energy while still fulfilling the requirements. It is even acceptable that the robot does not reach (WP_2) exactly, as long as the transition from the first trajectory to the second trajectory happens near this position.

The stop at (WP_2) can be avoided by configuring a blend for the waypoint. This allows the robot to calculate a smooth transition into the next trajectory.

The primary parameter for the blend is a radius.

When the robot is within the blend radius of the waypoint, it can start blending and deviate from the original path. This allows for faster and smoother movements, as the robot does not need to decelerate and re-accelerate.

Blend Parameters

Description Blending enables the robot to smoothly transition between two trajectories, without stopping at the waypoint between them. Blending makes your robot program run faster because, when you create a smooth transition between trajectories, you avoid slowing down an acceleration between trajectories.

Blend parameters

Apart from the waypoints, multiple parameters will influence the blend trajectory.

- the blend radius (r)
- the initial and final speed of the robot (at positions p_1 and p_2 , respectively)
- the movement time (e.g. if setting a specific time for a trajectory this will influence the initial/final speed of the robot)
- the trajectory types to blend from and to (MoveL, MoveJ)

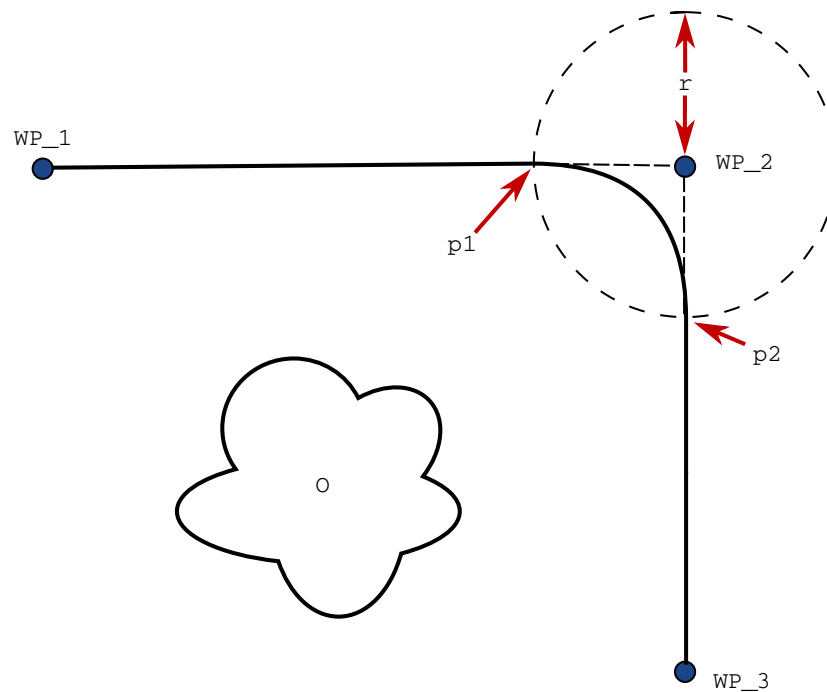

31.2: Blend over (WP_2) with radius (r), initial blend position at p_1 and final blend position at p_2 . (O) is an obstacle.

If a blend radius is set, the robot arm trajectory blends around the waypoint, allowing the robot arm not to stop at the point.

Blends cannot overlap, so it is not possible to set a blend radius that overlaps with the blend radius of a previous or following waypoint.

If there is overlap of two blends, there will be a warning logged in the Log tab. See the *Log tab* for more information.

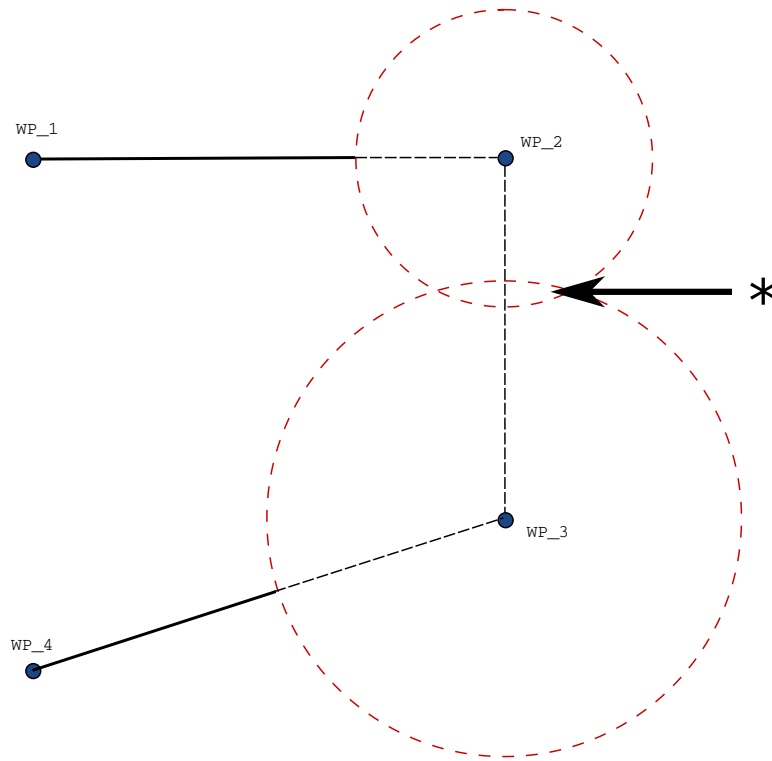

31.3: Blend radius overlap not allowed (*).

Blend Trajectories

Description

Blending enables the robot to smoothly transition between two trajectories, without stopping at the waypoint between them. Blending makes your robot program run faster because, when you create a smooth transition between trajectories, you avoid slowing down an acceleration between trajectories.

Blend Trajectories

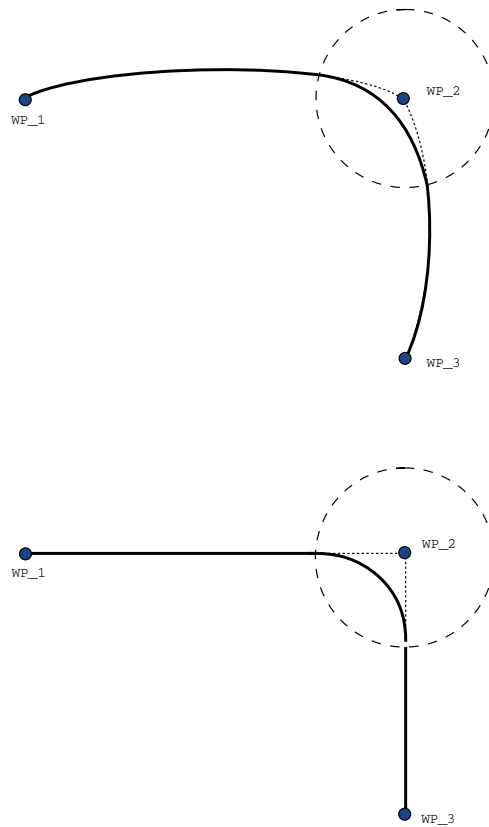

32.1: Joint space (*MoveJ*) vs. cartesian space (*MoveL*) movement and blend.

Depending on the movement type (i.e., MoveL, MoveJ, or MoveP), different blend trajectories are generated.

- **Blends in MoveP** When blending in MoveP, the position of the blend follows a circle arc at constant speed. The orientation blends with a smooth interpolation between the two trajectories. You can blend a MoveJ or a MoveL into a MoveP. In such a case, the robot uses the circular arc blend of MoveP, and interpolate the speed of the two motions. You cannot blend a MoveP to a MoveJ or a MoveL. Instead, the last waypoint of the MoveP is regarded as a stop point with no blend. You cannot perform a blend if the two trajectories are at an angle close to 180 degrees (reverse direction) because it creates a circular arc with a very small radius which the robot cannot follow at constant speed. This causes a runtime exception in the program which can be corrected by adjusting the waypoints to cause a less sharp angle.
- **Blends involving MoveJ** MoveJ blends cause a smooth curve in joint space. This goes for blends from MoveJ to MoveJ, MoveJ to MoveL and MoveL to MoveJ. The blend produces a smoother and faster trajectory than the movements without a blend (see Figure 15.6). If velocity and acceleration are used for specifying the velocity profile, the blend stays within the blend radius during the blend. If using *time* instead of *velocity* and *acceleration* for specifying the velocity profile of both motions, the blend trajectory follows the trajectory of the original MoveJ. When both motions are time constrained, using blends does not save time.
- **Blends in MoveL** When blending in MoveL, the position of the blend follows a circle arc at constant speed. The orientation blends with a smooth interpolation between the two trajectories. The robot may decelerate on the trajectory before following the circular arc to avoid very high accelerations (e.g., if the angle between the two trajectories are close to 180 degrees).

Conditional Blend Trajectories

Description

Blending enables the robot to smoothly transition between two trajectories, without stopping at the waypoint between them. Blending makes your robot program run faster because, when you create a smooth transition between trajectories, you avoid slowing down an acceleration between trajectories.

Conditional blend trajectories This example is a very situational example, but it shows that the robot program may in a very rare situations calculate program nodes before execution.

The blend trajectory is affected both by the waypoint where the blend radius is set and the following one in the program tree.

In this example, the blend around is affected by (WP_1) and (WP_2). The consequence of this becomes more apparent when blending around (WP_2) in this example.

There are two possible ending positions and to determine which is the next waypoint to blend to, the robot must evaluate the current reading of the `digital_input[1]` already when entering the blend radius.

That means the `if...then` expression is evaluated before we actually reach the destination which is somewhat counter-intuitive when looking at the program sequence. If a waypoint is a stop point and followed by conditional expressions to determine the next waypoint (e.g. the I/O command) it is executed when the robot arm has stopped at the waypoint. (WP_2)

```

MoveL
  WP_I
  WP_1 (blend)
  WP_2 (blend)
  if (digital_input[1]) then
    WP_F_1
  else
    WP_F_2

```

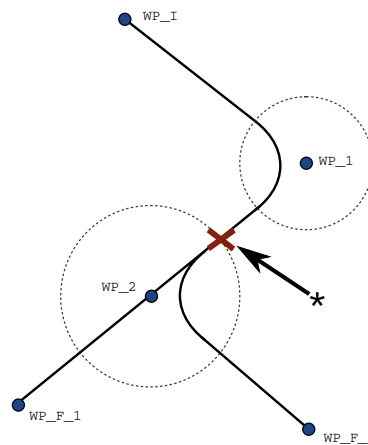

32.2: *WP_I is the initial waypoint and there are two potential final waypoints WP_F_1 and WP_F_2, depending on a conditional expression. The conditional if expression is evaluated when the robot arm enters the second blend (*).*

Add Until

Description

The program node **Until** defines stop criteria for a motion. You can add Until nodes from Direction and Waypoint commands. You can only add a direction node to a MoveL and MoveP. The robot moves along a path and stops when contact is detected.

You can add multiple stop criteria to a single movement. The motion stops when the first **Until** condition is met.

You can add multiple Add Until one after the other, because there can be multiple conditions that must be met, before an action is done or executed.

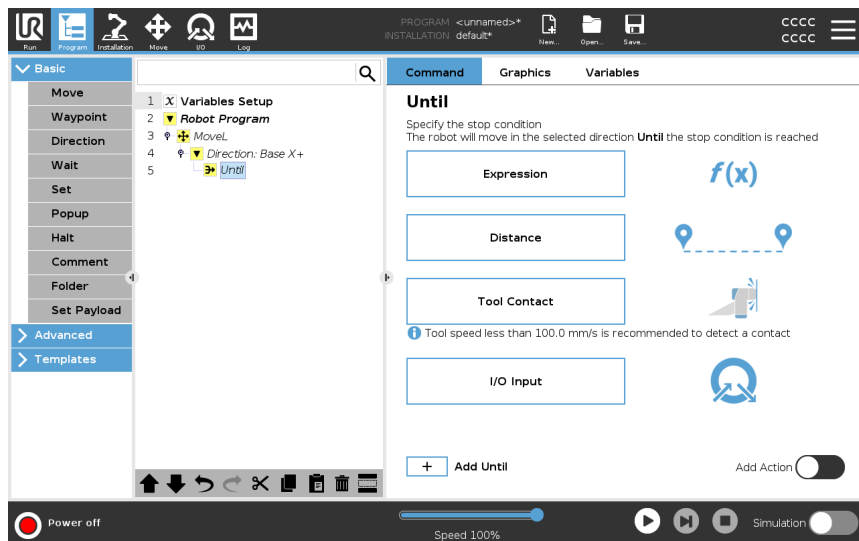

- Distance
- Tool Contact: (see [19.7.3 Direction on page 218](#))
- Expression
- I/O Input:
- Add Action

Expression

This node uses a custom program expression to stop the robot's motion. You can also use an expression to specify a stop condition.

Stop conditions can also be specified using variables and script functions.

Add an Until expression to a robot program

1. When you have added the Until command, tap the



2. Tap the yellow expression field
3. Add the expression with the keyboard



4. Tap Submit to save the expression
5. Choose if you want to use the shared deceleration or a custom deceleration

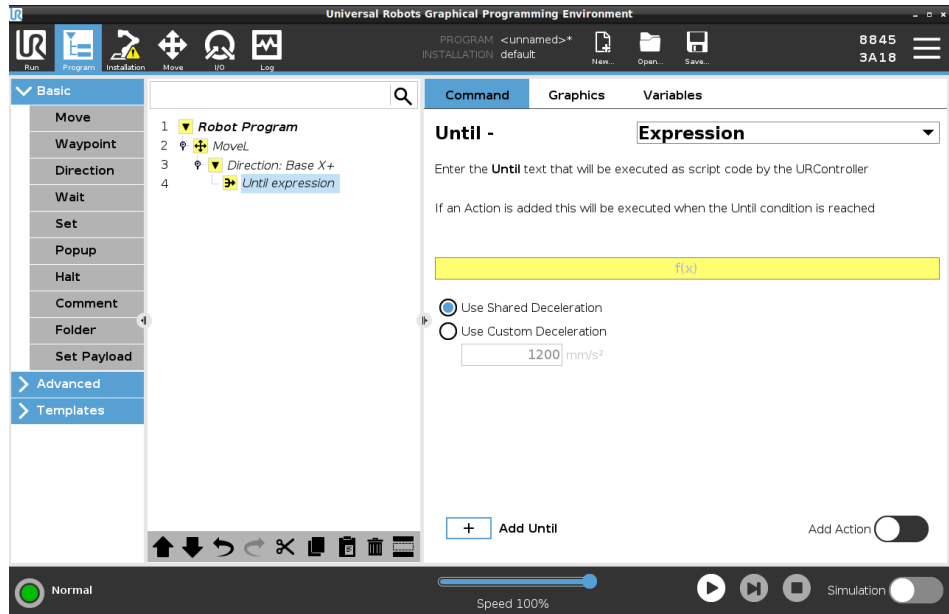

Distance

This node stops a Direction move when the robot moves a certain distance. The velocity is ramped down so the robot stops exactly at the specific distance. You can also use a specific distance as a stop condition.

Example

You can use the distance function to move the tool a specific distance before a full stop such as moving the tool away from a work piece.

Add an Until distance to a robot program

1. When you have added the Until command, tap the



2. Add the distance in mm
3. Select to stop after it has moved the distance or blend with a radius. [Click here to read more about blending.](#)

Tool Contact

This node allows the robot to stop motion when contact with the tool is established. You can use this node to stop a movement when the robot tool detects a contact.

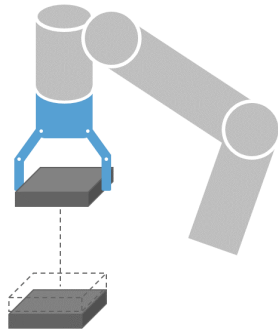

You can also define the deceleration of the stop and the retraction of the tool.

Example

You can use the Until Tool Contact Node for applications like Stacking/Unstacking, where Until Tool Contact determines the height of stacked objects.

Add a Until tool contact to a robot program

1. When you have added the Until command, tap the

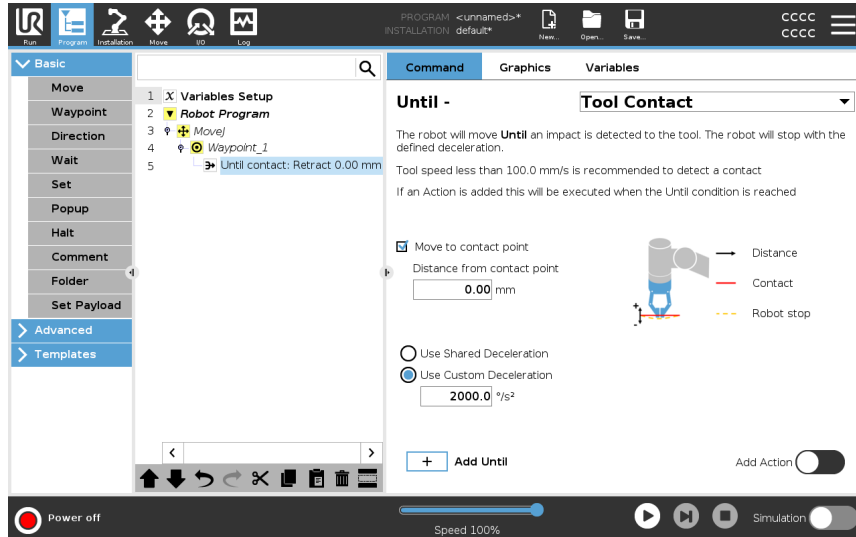

CAUTION

The default speed of motion is too high for contact detection. A faster speed of motion triggers a robot stop, before the Tool Contact condition can take effect. To avoid triggering a robot stop, lower the speed of motion. For example: 100m/s.



NOTICE

Until Tool Contact might not work if the mounted tool vibrates. For example: a vacuum gripper with an embedded pump can introduce fast vibrations.

Detail

Use the **Retract to Contact** setting for the robot to return to the initial point of contact. You can set an additional reverse movement to make the robot move free of, or toward, contact. This is useful if you have a gripper that needs free space to move, or if a clamping action is needed.

I/O Input

This node uses an I/O input to stop a signal controlled motion. You can also use an I/O input to specify a stop condition.

add a No Action to a robot program

1. When you have added the Until command, tap the

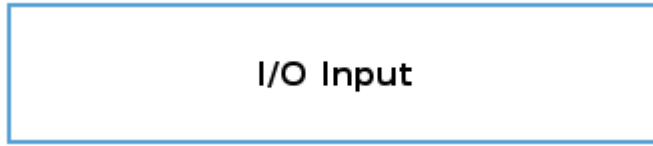

2. Select the analogue or digital input
3. Add additional configuration

Add Action

This node allows you to add a program node if a specific Until condition is met. You can also add an additional action to be executed right after an Until command.

Example

Until Tool Contact can engage the gripping action of a gripper tool. If no **Action** is defined, then program execution continues to the next program node in the Program Tree.

Add a No Action after an Until command

1. Tap the **Add Action** 
2. Select a node from the Node List to be added immediately after the Until command
3. Configure the node you just added

19.7.3. Direction

Description

The Direction command specifies a motion relative to feature axes or TCPs. The robot moves in the path specified by the Direction program node until that movement is stopped by an [Add Until on page 213](#) condition.

Direction

The Direction command allows you to make the robot move in a specific direction.

Example

Direction vectors of [100,0,0] and [1,0,0] have the same effect on the robot; use the Speed Slider to moving along the x-axis at a desired speed. The values of the numbers in the direction vector only matter relative to each other.

Add a Direction movement to a robot program

1. In your robot program, select the place or node where you wish to add a Direction command.
2. Under Basic, tap **Direction** to add a linear movement to your Program Tree.
3. In the Direction field, under Feature, define the linear movement.

a. Select if you use the shared feature Use shared feature

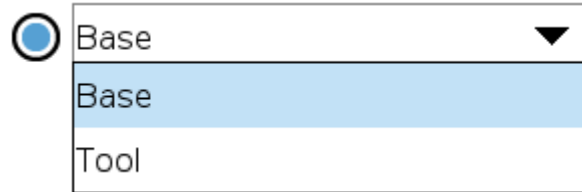

or the Base/Tool

b. Select the cartesian direction from the Direction drop-down
Direction

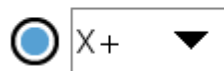

or write the Direction vector manually

Direction vector



c. Select Shared parameters or define the tool speed and acceleration.

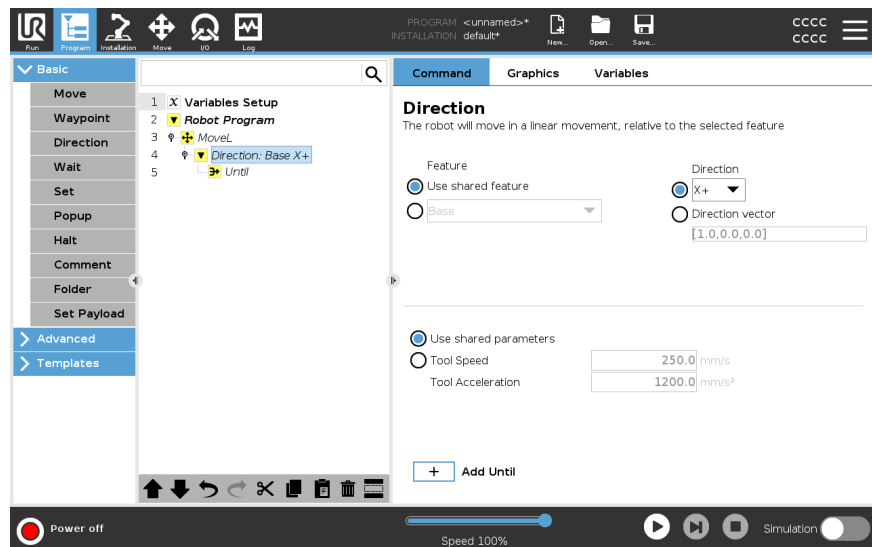

4. Click Add Until to add a method of stopping the directional movement.

Select the feature and direction

Difference between Shared Feature or BASE/TOOL

Difference between Direction and writing the Direction Vector

The Direction Vectors define a custom code expression that is resolved to a unit vector.

Direction Movement

There are different ways to stop direction movement.

In the Direction field, tap the **Add Until** button to define and add stop criteria to your Program Tree.

- Direction Vector** The Direction Vector settings allow you to define the vector direction for linear motion. Use the **Tool Speed** and **Tool Acceleration** for the following:
- to define linear motion relative to multiple feature axes
 - to calculate the direction as a mathematical expression
-

19.7.4. Wait

Description The Wait command provides additional control of the robot's behavior. The Wait command pauses the robot's movement when new inputs are introduced into the program.

You can add a Wait command to a program with external sensors, to make the robot wait for one of the sensors to activate before the program continues.

When you add a Wait to your program tree, the Wait pane appears to the right of the screen.

See the following sections about using Wait:
The robot pauses using different Wait commands.
See the Wait command types below.

- Add a No Wait to a robot program** No Wait allows the robot to do nothing before continuing to run a program. There is no pause before new input.

1. In your Robot Program, select the place or node where you wish to add a Wait command.
2. Under Basic, tap **Wait**.
3. On the right side of the screen, tap the **No wait** selector.

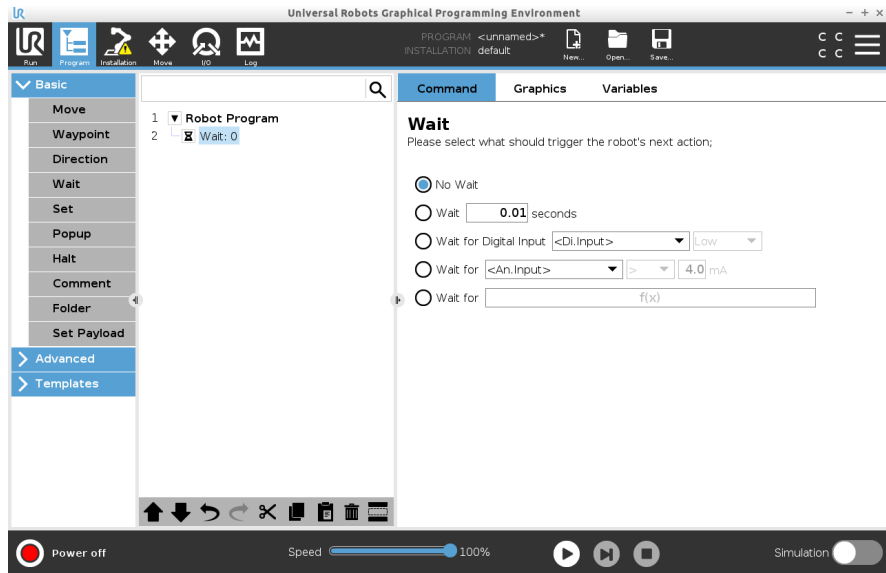

The No Wait command can be used a temporary placeholder be used, when you are programming your robot program.

Add Wait x seconds to a robot program

This Wait command type allows the robot to hold position for a defined amount of time before continuing a program.

1. In your Robot Program, select the place or node where you wish to add a Wait command.
2. Under Basic, tap **Wait**.
3. Tap the **Wait x seconds** selector.

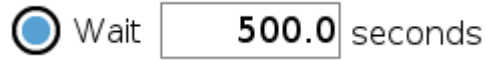

4. Tap the number box to select a value that determines the length of the Wait.

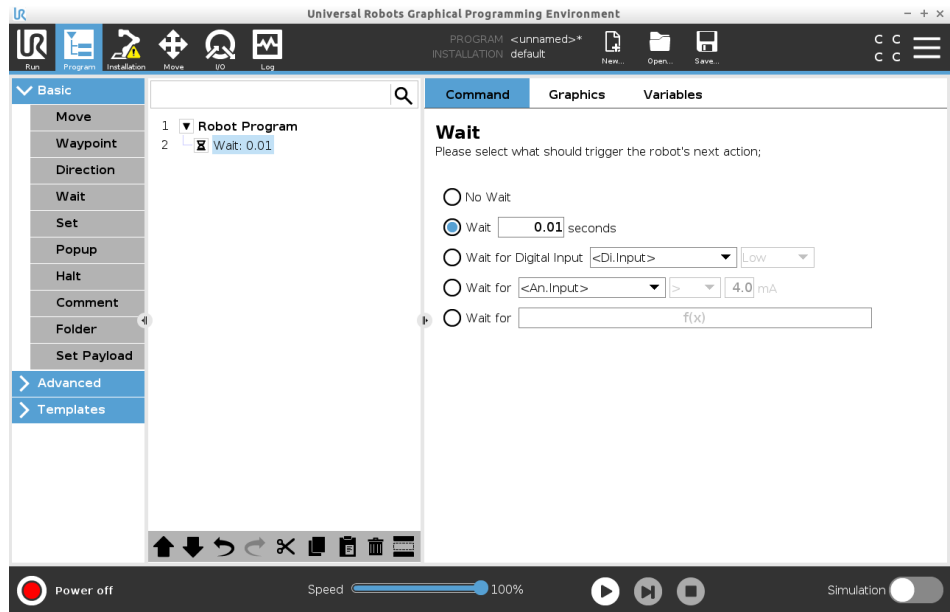

Example: Wait x seconds

1. If you have an object that needs to cool down to a specific temperature, you can add this time delay into the robot program.
2. If you need an external operation to finish before continuing with the robot program.

Wait for digital input

This Wait command type allows the robot to hold position until a signal is received from a digital input.

Add a Wait for digital input to a robot program

1. In your Robot Program, select the place or node where you wish to add a Wait command.
2. Under Basic, tap **Wait**.
3. Tap the **Wait for Digital Input** selector.

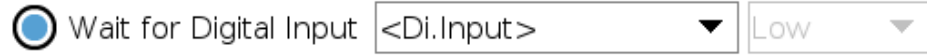

More definition is required for this Wait type.

4. In the **Di.Input** dropdown menu, select a new digital input.
5. In the signal box, assign a Low or High signal type to the new digital input.

If you have multiple digital inputs, you can rename each one to make it easier to find them.

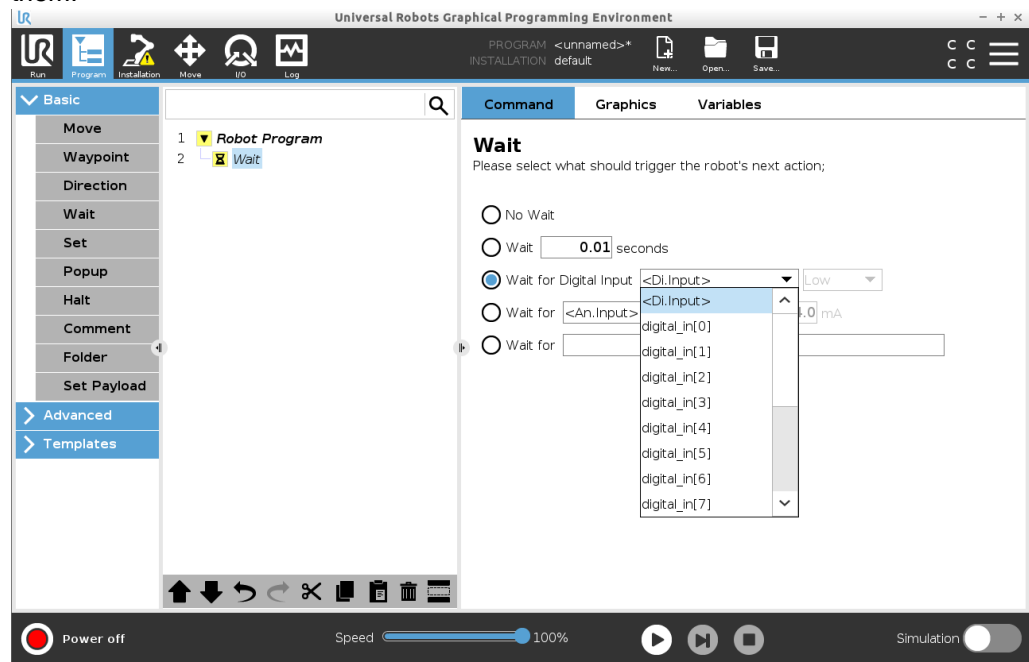

Example: Wait for digital input

If you have an external sensor at the end of a conveyor, you will use this function to wait for a command from the sensor, which tells the robot program that there is a work piece at the end of the conveyor.

Wait for analog input

This Wait command type allows the robot to hold position until a signal is received from an analog input.

Add a Wait for analog input to a robot program

1. In your Robot Program, select the place or node where you wish to add a Wait command.
2. Under Basic, tap **Wait**.
3. Tap the **Wait for analog input** selector.



4. In the **An.input** menu, select the new analog input.
5. Tap the Volts box to select a value that determines the voltage.
6. In the angle brackets box, select either the less than <, or the greater than > symbol.

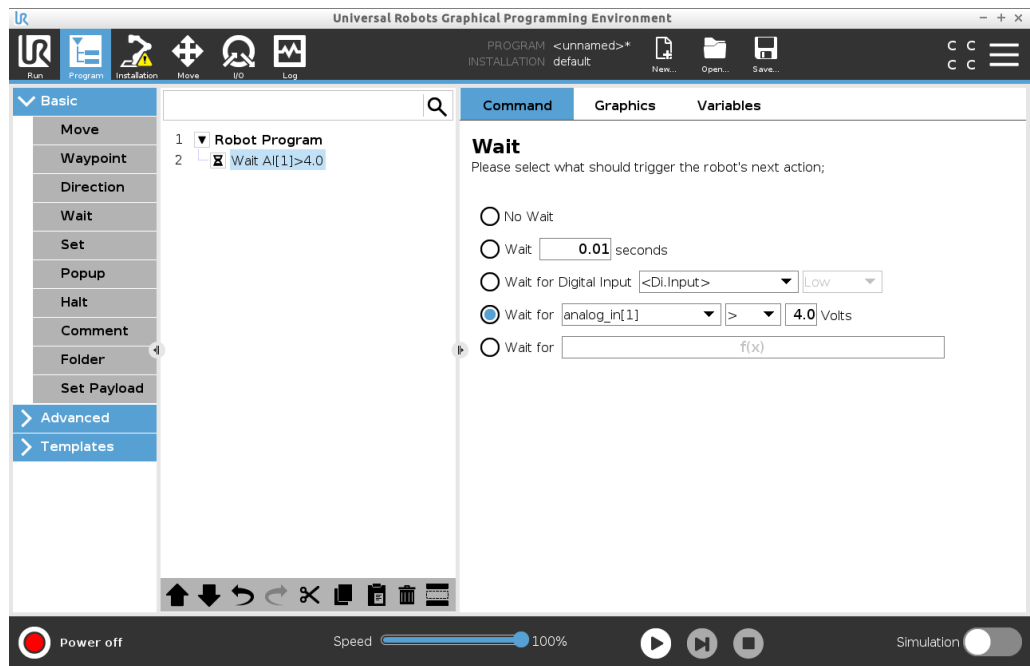

Tip

If you have multiple analog inputs, you can rename each one to make it easier to find them. [Go to I/O setup]

Example: Wait for analog input

If you have a temperature sensor that is set up to the analogue I/O, you can configure the robot program to wait until a specific temperature.

Wait for f(x) expression

This Wait command type allows the robot to hold position until an expression is *True* or *[1]*

Add a Wait for f(x) variable to a robot program

1. In your Robot Program, select the place or node where you wish to add a Wait command.
2. Under Basic, tap **Wait**.
3. Tap the **Wait for f(x)** selector.



4. Tap the **f(x)** variable field to add an expression value.

Example: Wait for f (x) expression

You can add a wait command with an expression that waits for two or more conditions to be true or false depending on configuration when using a machine and a conveyor sensor. Both the machine and the conveyor become ready for the robot.

19.7.5. Set

Description

The Set command is one of the most often used commands. The Set command can turn external devices on and off. The Set command can also increase or decrease current/voltage to external devices. You can always test your setup by using the test button in the right lower corner of the screen. See the following sections about using Set: The robot uses different Set commands. See the Set command types below.

No Action

This is used in combination with setting the active TCP.

To add a No Action to a robot program

1. In your Robot Program, select the place or node where you wish to add a Set command.
2. Under Basic, tap **Set**.
3. Select No Action

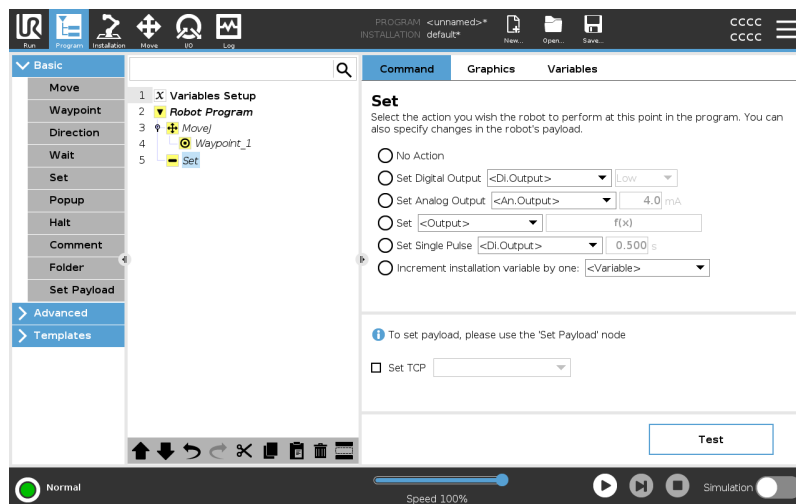

Set digital output

The digital output should be planned as a start/stop or on/off action.

1. In your Robot Program, select the place or node where you wish to add a Set command.
2. Under Basic, tap **Set**.
3. Select Set Digital Output
4. Select your pre-named digital output (See [20.4 I/O Setup on page 281](#))
5. Set to High/Low

Example: Set digital output

Use this Set command, if you want a conveyor to start or stop moving.

Set analog output

The analogue output should be planned as a variable increase/decrease in current/voltage.

1. In your Robot Program, select the place or node where you wish to add a Set command.
2. Under Basic, tap **Set**.
3. Select Analog Output
4. Select your pre-named analogue output (See [20.4 I/O Setup on page 281](#))
5. Input desired value (current or voltage depending on configuration in [22 I/O Tab on page 320](#))

Example: Set analog output

Use this command, if you wish to increase the speed of a conveyor or dim the light in a lamp or diode.

Set (variable)

The output can also be modified by an expression.

1. In your Robot Program, select the place or node where you wish to add a Set command.
2. Under Basic, tap **Set**.
3. Select Set
4. Choose the pre-named output
5. Add the expression in the input field.

Example: Set (variable)

You can set an output to list the output torque of a robot joint.

Set single pulse

The Set command can be used to deliver a steady pulse of a specific duration. The output will remain High during the pulse, and return to Low after the pulse has ended.

1. In your Robot Program, select the place or node where you wish to add a Set command.
2. Under Basic, tap **Set**.
3. Select Set Single Pulse
4. Select your pre-named digital output
5. Add your duration for the pulse in (s)

Example: Set single pulse

In order to ensure valid communication with older machinery, you can set a pulse to a high command for a duration, so that you ensure that the older machinery has time to register the command.

Increment installation variable by one

This is used to increase the number of a counter variable.

1. In your Robot Program, select the place or node where you wish to add a Set command.
2. Under Basic, tap **Set**.
3. Select Increment installation variable by one
4. Select your variable from the dropdown menu.

Example

If you need to know how many items that the robot has handled, you can add a counter and this Set command to increase the counter.

Set TCP

1. In your Robot Program, select the place or node where you wish to add a Set command.
2. Under Basic, tap **Set**
 - a. You can set the active TCP with any command variation from the above.
3. Tap Set TCP
4. Select TCP from dropdown menu

Example: Set TCP

If you have a double gripper, you can use the Set command to change the active TCP to the other gripper.

19.7.6. Popup

Description

The Popup is a message that appears on the screen when the program reaches the Popup node in the program tree. Popup messages are limited to a maximum of 255 characters. You can choose to use different popup message types.

- Message
- Warning
- Error

A popup always pauses the main robot program. The main robot program is paused while the popup is active.

When to use:

- When you wish to continue or stop your program.
- When you wish to create a message to inform users.
- When you wish to control your part of a robot program.

Add a Popup to a robot program

1. In your robot program, select the place or node where you wish to add a Popup command.
2. Under Basic, tap **Popup**.
3. Add your text or choose a variable
4. Choose the popup type. The only change is the icon of the popup.

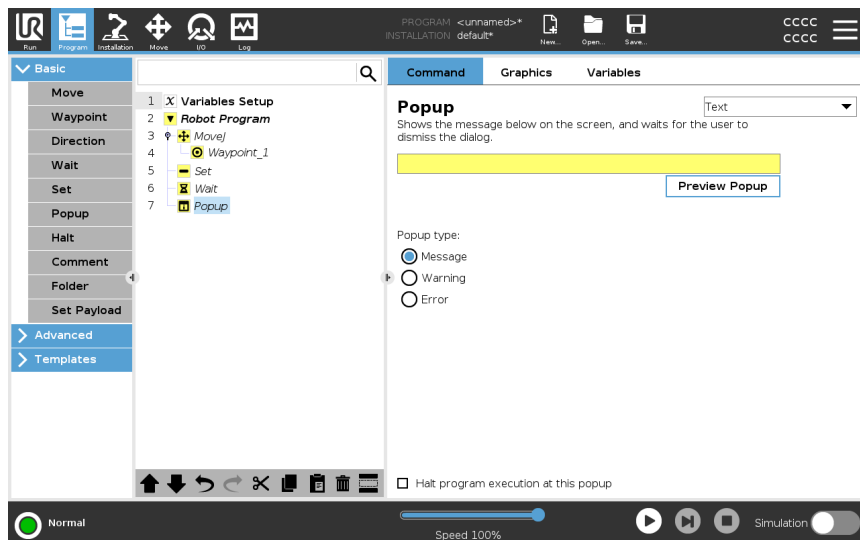

Tip

You can also select **Halt program execution at this popup** for the program to stop when the popup appears.

Example: Popup

In a pick and place program, you can add a Message popup when the pallet is full and you need to add an empty pallet. During an inspection, you can add a Warning popup where you inspect an object. If the inspection is OK, continue the program. If the inspection is NOT OK, stop the program.

19.7.7. Halt

Description

The Halt command allows you to stop the robot at a specific node in the robot program. It is the equivalent of pressing the STOP button.

You must restart the program after the halt command.

When you add a Halt to your robot program, the Halt pane appears to the right of the screen.

When to use:

- Include a Halt command if you reach a position with the robot program, where recovery is not possible, and you need to stop the program.

Halt

Add stops to specific points in the robot program.

Add a Halt to a robot program

1. In your robot program, select the place or node where you wish to add a Halt command.
2. Under Basic, tap **Halt**.

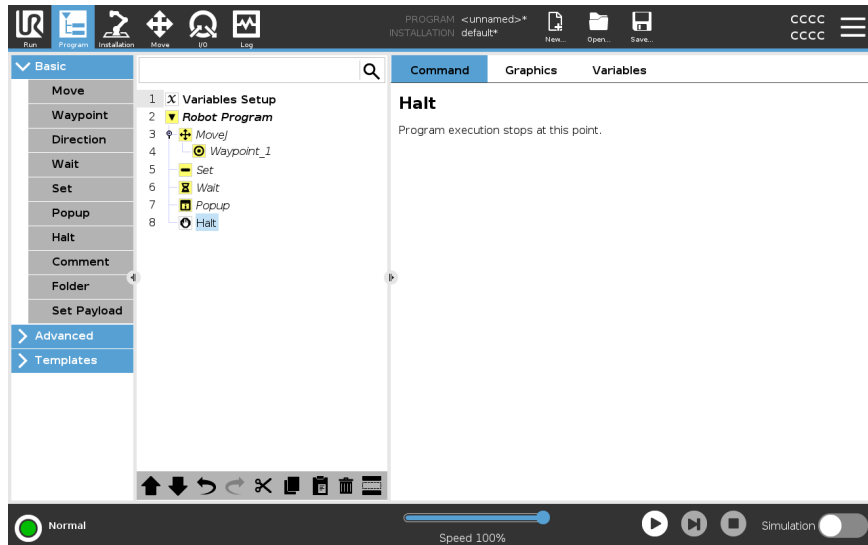

Example: Halt

If there are no more parts for a welding application, or one of the parts have been incorrectly placed in the welding pattern, you can add a Halt command.

19.7.8. Comment

Description

The Comment command allows you to keep track of decisions you make while you create or update your robot program.

You can add comments directly inside a robot program used by different users.

When you add a Comment to your robot program, the Comment pane appears to the right of the screen. The content of the comment displays in the Comment pane.

Comments have no impact on the program's execution.

Comment

Add useful comments throughout the robot program.

Add a Comment to a robot program

1. In your robot program, select a node to add a comment.
2. Under Basic, tap Comment.
3. Add your comment in the text field.

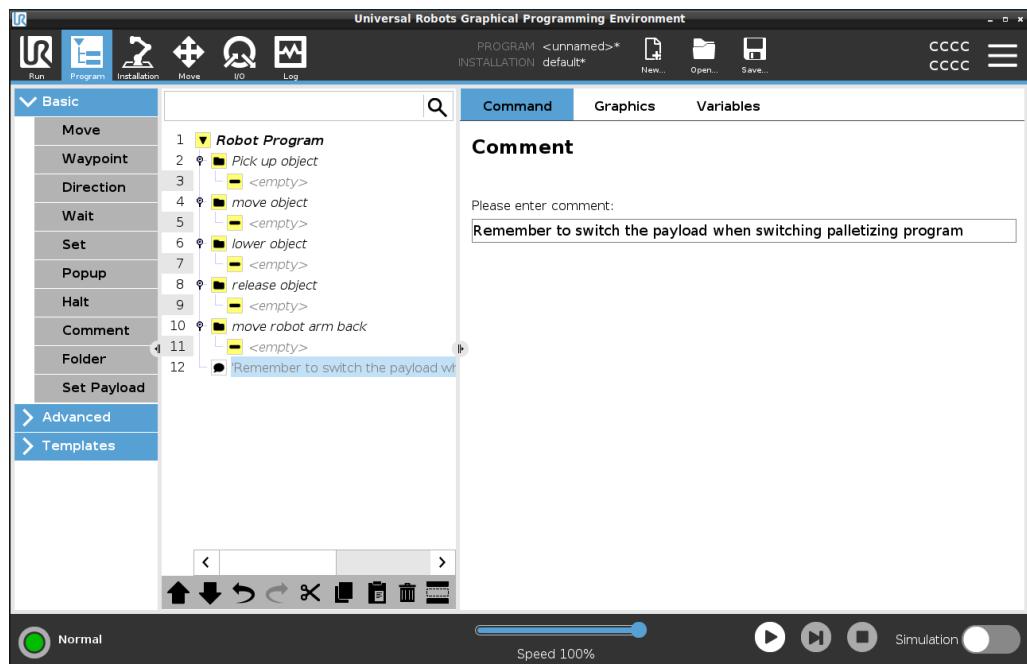

Example: Comment

The comments are mainly used by programmers to provide insight and help to other programmers on the same robot program.

19.7.9. Folder

Description

The Folder command allows you to use folders to create an easy to read overview of the main parts of your robot program.

Since each main part of the robot program can contain many program nodes, you can use folders to separate them into manageable sections.

Folders have no impact on the program's execution.

Folder

Organize your robot program in folders.

Add a Folder to a robot program

1. In your robot program, select a placement for your folder.
2. Under Basic, tap Folder.
3. You can now move nodes into the folder, or add nodes in the folder.

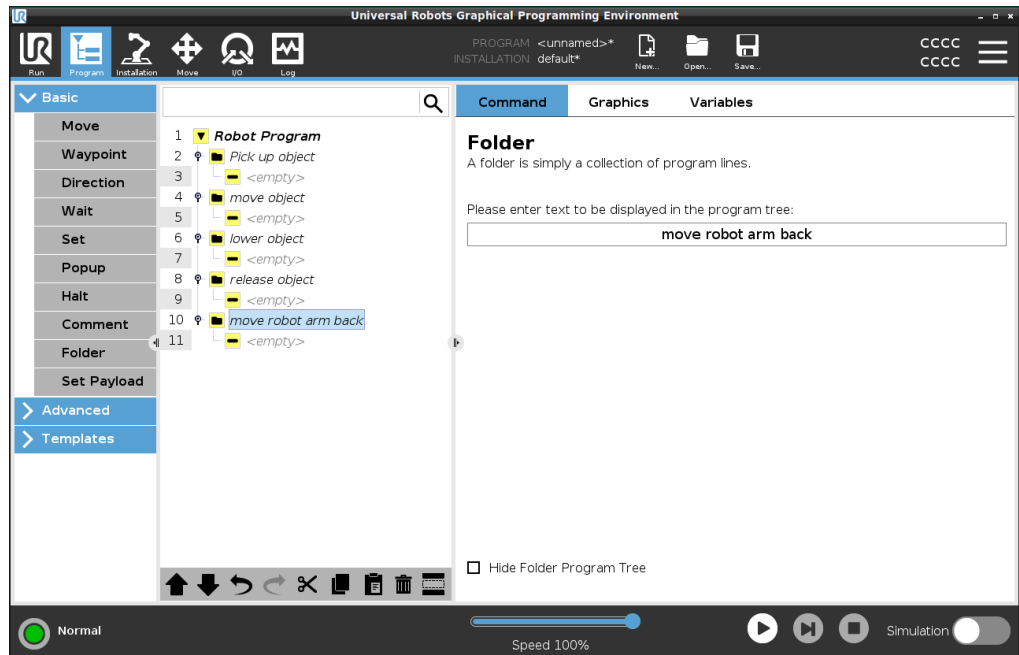

Example: Folder

One of the main uses of Folders is to collapse main sections of the robot program to provide a better overview of the robot program.

19.7.10. Set Payload

Description

The **Set Payload** command allows you to configure the payload for the robot. Payload is the combined weight of everything attached to the robot tool flange.

When to use:

- When adjusting the payload weight to prevent the robot from triggering a robot stop. A correctly configured payload weight ensures optimal robot movement. Setting the payload correctly ensures optimal motion performance and avoids robot stops.
- When setting up the payload for use in a pick and place program, using a gripper.

Set Payload

Use the Set Payload command

1. In your robot program, select the place or node where you wish to add a **Set** command.
2. Under **Basic**, tap **Set Payload**.
3. Use the drop-down, under **Select Payload**.
 - a. Select one of the payloads already configured.
 - b. Or, use the drop-down to configure a new payload by selecting **Custom Payload** and completing the mass and CoG fields.

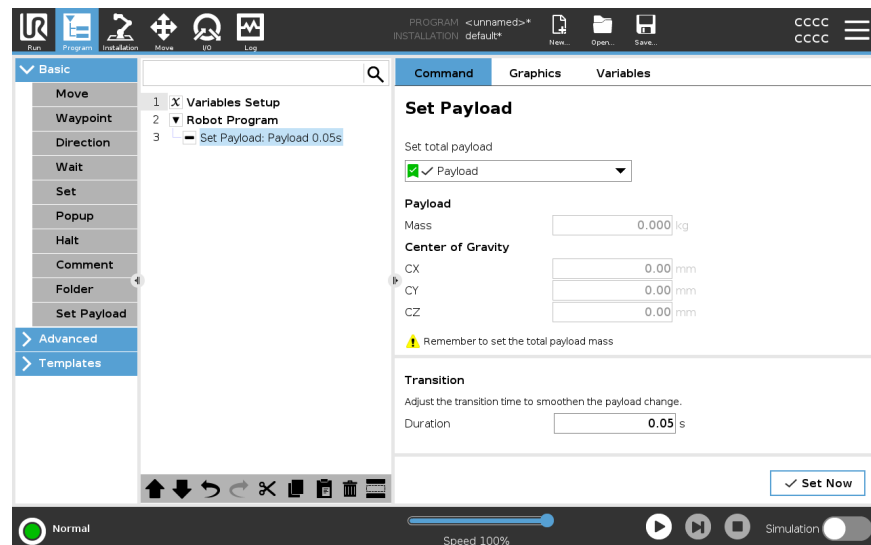

Tip

You can also use the **Set Now** button to set the values on the node as the active payload.

Use tip

Remember to always update your payload when making any changes to the configuration of the robot program.



Example: Set Payload In a pick and place program, you would create a default payload in the installation. Then you add a Set Payload when picking up an object. You would update the payload after the gripper closes, but before starting to move. Additionally, you would use the Set Payload after the object has been released.

Payload Transition Time This is the time it takes the robot to adjust for a given payload. At the bottom of the screen, you can set the transition time between different payloads. You can add a payload transition time in seconds. Setting a transition time larger than zero, prevents the robot from doing a small "jump", when the payload changes. The program continues while the adjustment is taking place. Using the Payload Transition Time is recommended when picking up or releasing heavy objects or using a vacuum gripper.

19.8. Advanced program nodes

Description The advanced program nodes are used to add additional functionality for your robot program, such as; subprograms, if-parameters, scripts and loops.

19.8.1. Loop

Description Loops the underlying program commands. Depending on the selection, the underlying program commands are either looped infinitely, a certain number of times or as long as the given condition is true. When looping a certain number of times, a dedicated loop variable (called `loop_1` in the screen shot above) is created, which can be used in expressions within the loop. The loop variable counts from 0 to $N - 1$.

Looping an Expression

When looping using an expression as end condition, PolyScope provides an option for continuously evaluating that expression, so that the “loop” can be interrupted anytime during its execution, rather than just after each iteration.

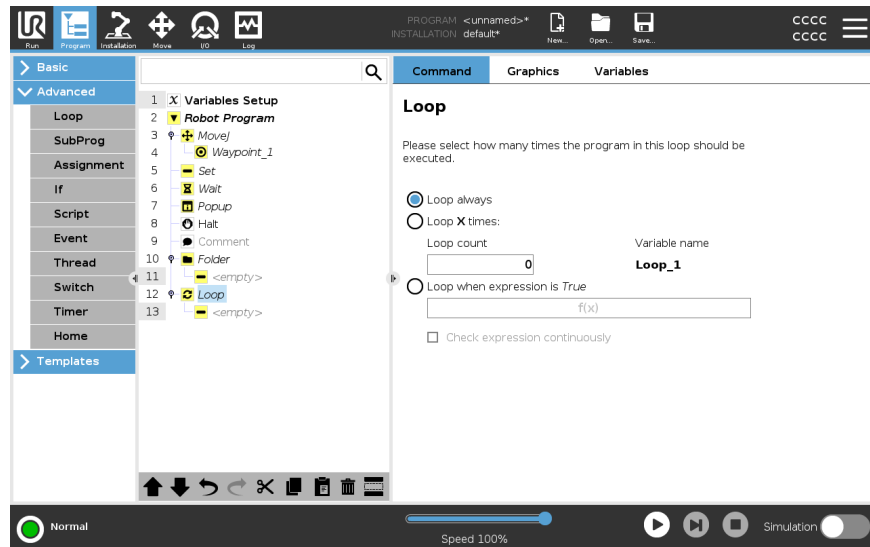

19.8.2. SubProgram

Description

A SubProgram can hold program parts that are needed several places. A SubProgram can be a separate file on the disk, and can also be hidden to protect against accidental changes to the SubProgram.

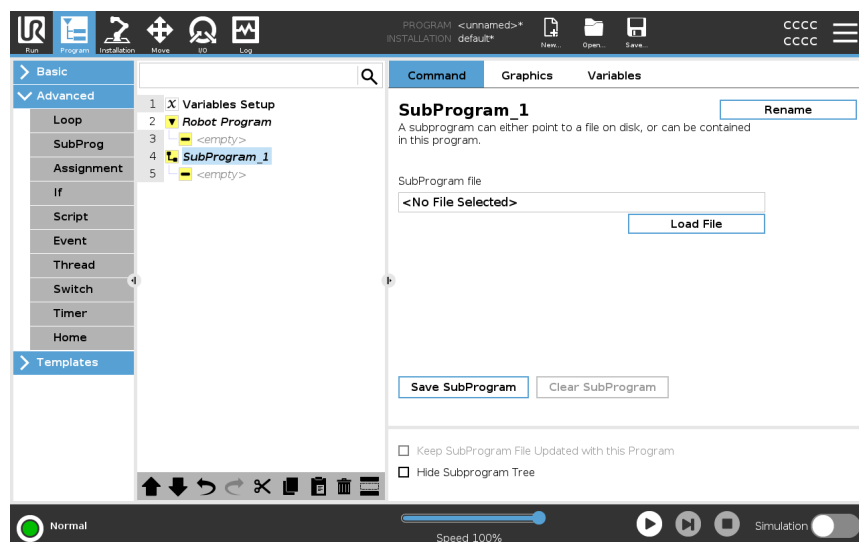

Call Subroutine A call to a Subroutine will run the program lines in the SubProgram, and then return to the following line.

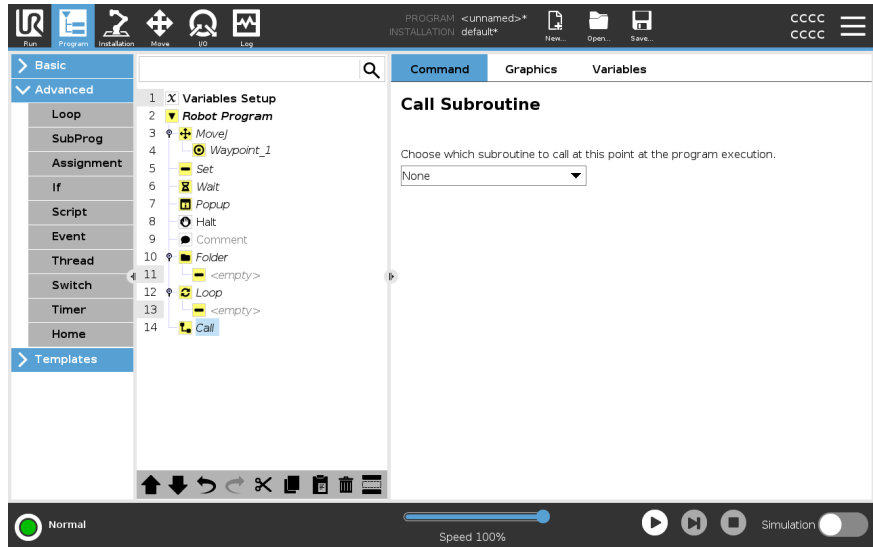

19.8.3. Assignment

Description

Assigns values to the variables. The variable value can be the result of expressions created in the Expression Editor (see section [19.3 Expression Editor on page 184](#)). You can also request a variable value from an operator. When requesting a value from an operator, it is possible to display an Operator Message to validate input against common variable types.

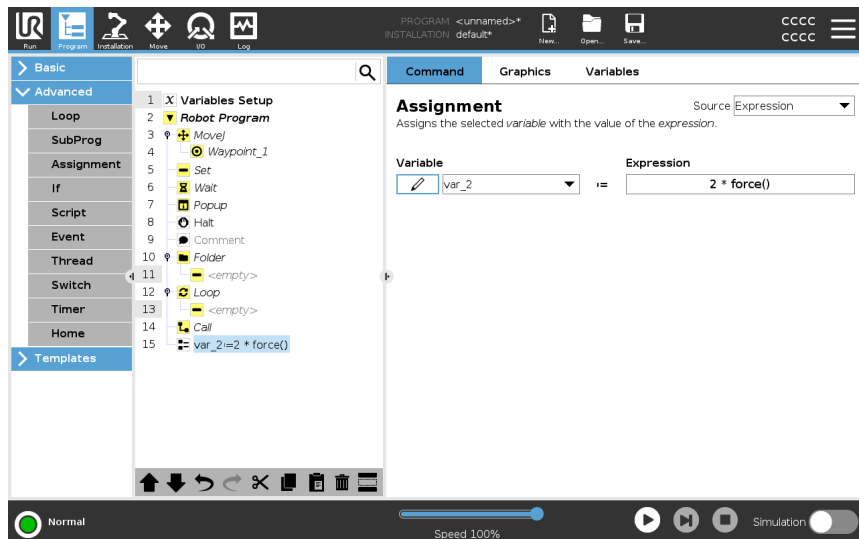

19.8.4. If

Description

If and **If...Else** statements change the robot's behavior based on sensor inputs or variable values.



NOTICE

If there are waypoints inside an If expression or inside a Loop expression with the Check Expression Continuously option, you can add a `stopj()` or a `stopl()` after the expression to gently decelerate the robot arm. This is valid for both If and Loop Commands (see section).

Select Conditions Select conditions in the Expression Editor that make up expressions using an **If** statement. If a condition is evaluated as True, the statements within this **If** command are executed. An **If** statement can have only one **Else** statement. Use **Add Elseif** and **Remove Elseif** to add and remove Elseif expressions. Select **Check Expression Continuously** to allow **If**, **Elseif** and **Loop** statements to be evaluated while the contained lines are executed. If an expression inside an **If** statement is evaluated as False, the **Elseif** or **Else** statements are followed.

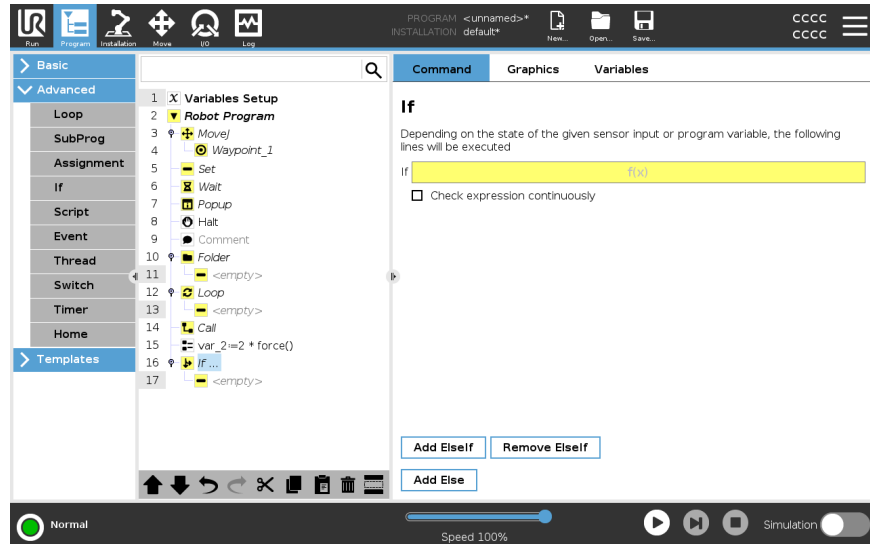

19.8.5. Script

Description

The following options are available in the drop down list under Command:

- **Line** allows you to write a single line of URScript code, using the Expression Editor ([19.3 Expression Editor on page 184](#))
- **File** allows you to write, edit or load URScript files.

You can find instructions for writing URScript in the Script Manual on the support website (<http://www.universal-robots.com/support>).

Functions and variables declared in a URScript file are available for use throughout the program in the PolyScope.

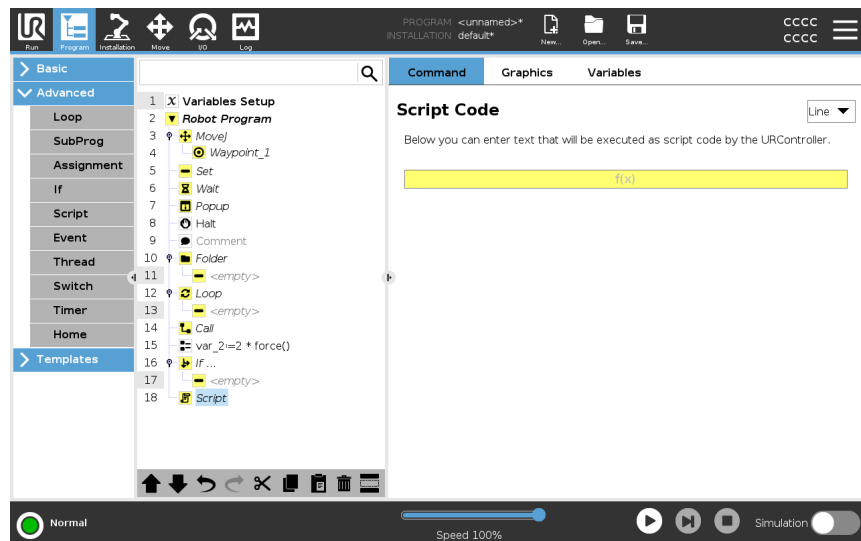

19.8.6. Event

Description

An event can be used to monitor an input signal, and perform some action or set a variable when that input signal goes high.

For example, in the event that an output signal goes high, the event program can wait for 200ms and then set it back to low again.

This can make the main program code a lot simpler in the case on an external machine triggering on a rising flank rather than a high input level.

Events are checked once every control cycle (2ms) .

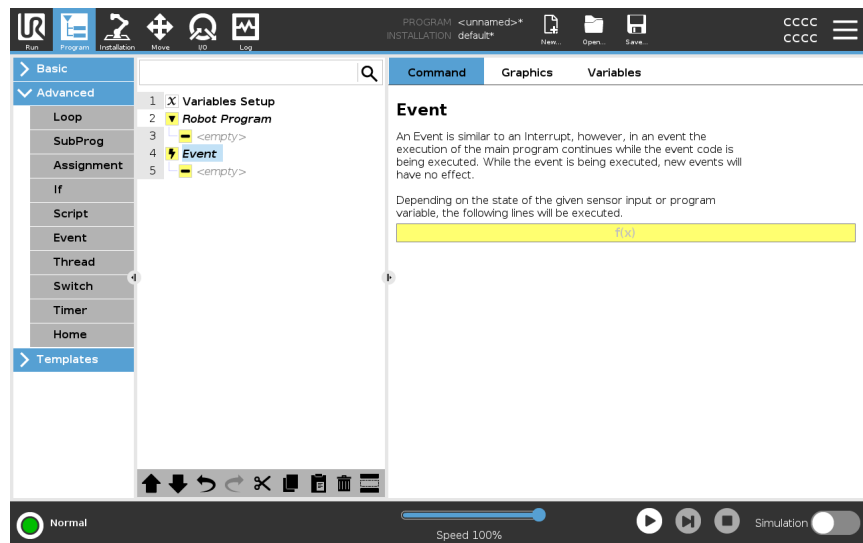

19.8.7. Thread

Description

A thread is a parallel process to the robot program. A thread can be used to control an external machine independently of the robot arm. A thread can communicate with the robot program with variables and output signals.

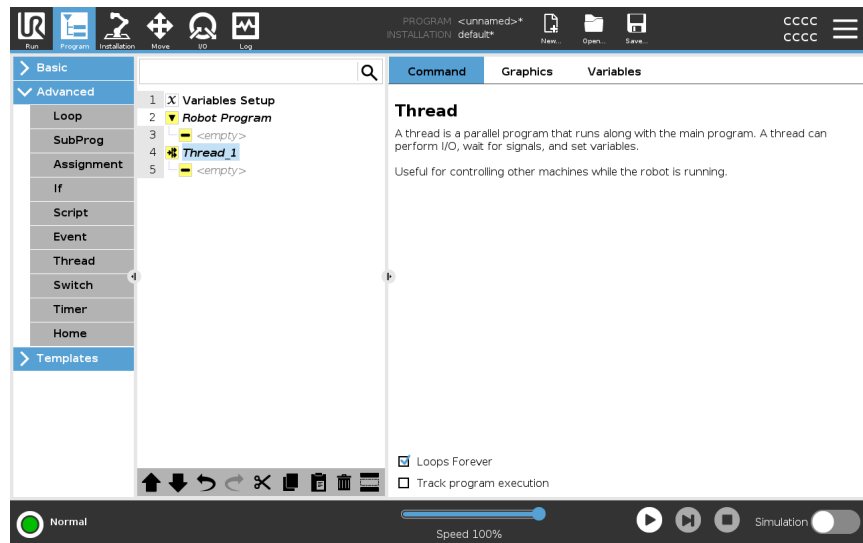

19.8.8. Switch

Description

A **Switch Case** construction can make the robot change behavior based on sensor inputs or variable values.

Use the **Expression Editor** to describe the base condition and define the cases under which the robot should proceed to the sub-commands of this **Switch**.

If the condition is evaluated to match one of the cases, the lines inside the **Case** are executed. If a **Default Case** has been specified, then the lines will be executed only if no other matching cases were found.

Each Switch can have several Cases and one Default Case. Switches can only have one instance of any Case values defined. Cases can be added using the buttons on the screen. A Case command can be removed from the screen for that switch.

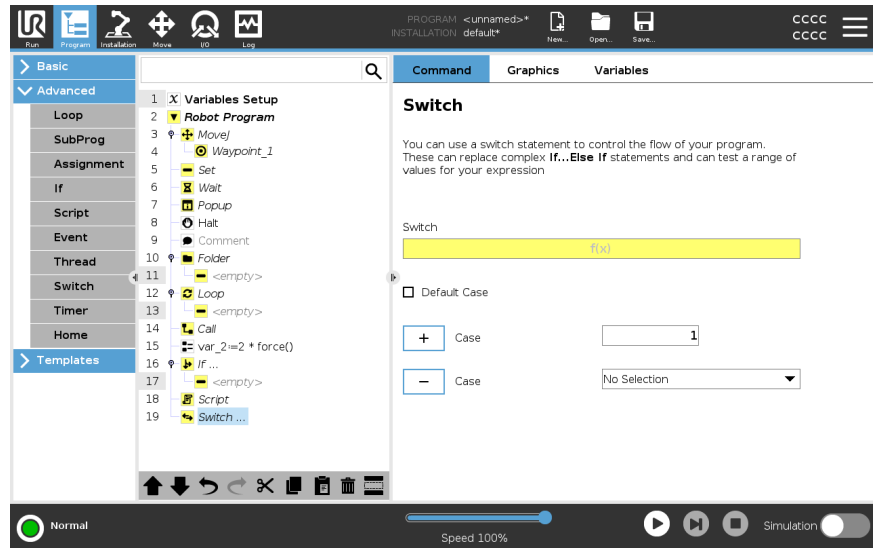

19.8.9. Timer

Description

A Timer measures the length of time it takes for specific parts of the program to run. A program variable contains the time passed since a Timer started, and can be seen in the Variables Tab and in the Run Tab.

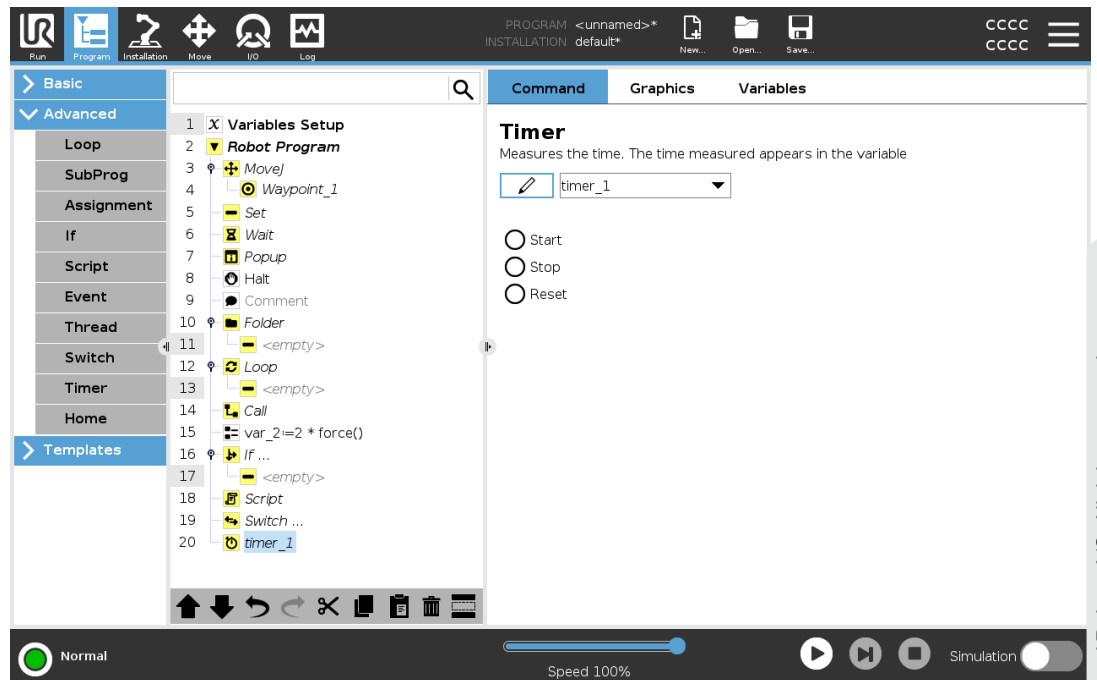

19.8.10. Home

Description The Home node uses joint angles to move the robot to a predefined Home position. If defined as a Safe Home position, the Home node displays as Home(Safety) in the Program Tree. If the Home position is out of sync with Safety, the node is undefined.

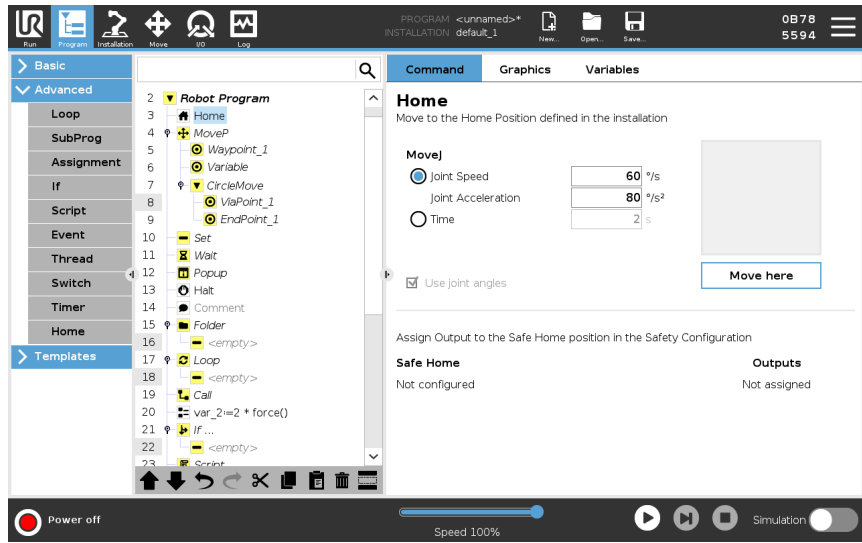

Defining Home Home is a user-defined return position for the Robot Arm. Once defined, the Home Position is available when creating a robot program. You can use the Home Position to define a Safe Home Position. (See [17.9 Safe Home Position on page 163](#)) Use the Home screen buttons for the following:

- **Edit Position** modifies a Home Position.
 - **Move here** moves the Robot Arm to the defined Home Position.
 - **Zero Position** returns the Robot Arm to an upright position.
1. In the Header, tap **Installation**.
 2. Under **General**, select **Home**.
 3. Tap **Set Position**.
 4. Teach robot using either **Freedrive** or **Transition** buttons.

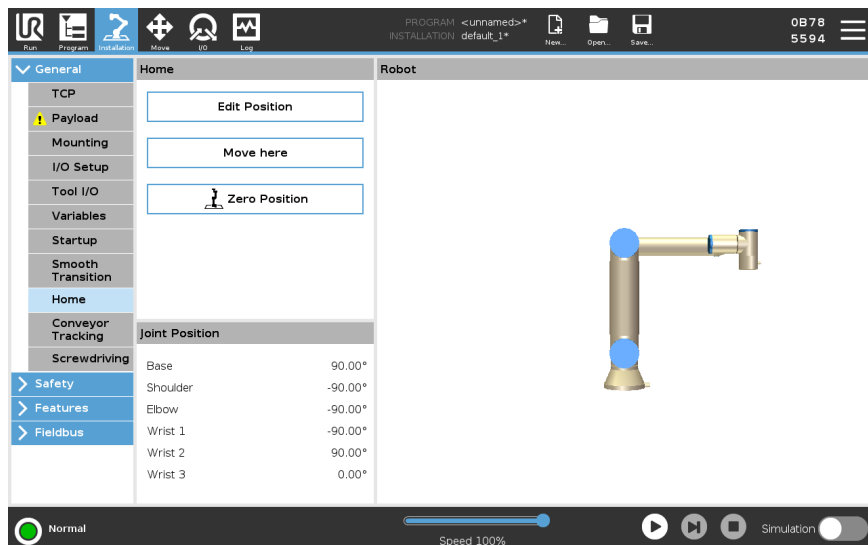

19.9. Templates

Description The templates can be used to add specific functionality to a robot program. The different templates will enable the you to perform complex tasks with your robot program.

19.9.1. Seek

Description The seek function uses a sensor to determine the correct position to grab or drop an item. This function allows for working on stacks of items of varying thickness, and determining the exact positions of the items are either unknown or too hard to program.
The sensor can be a push button switch, a pressure sensor or a capacitive sensor.

Seek To program a seek operation, define the following:

- *A* - the starting point.
- *B to C* - the stack direction. This means growing the stack when Stacking and shrinking the stack when Destacking.
- *D* - the thickness of the items in the stack.

You must also define the condition for when the next stack position is reached, and a special program sequence that is performed at each stack position.
Speed and accelerations need to be given for the movement involved in the stack operation.

Stacking

During Stacking, the robot arm moves to point A, then moves *opposite* the direction to search for the next stack position. When the next stack position is found, the robot remembers it and performs the special sequence.

In subsequent rounds, the robot starts the search from the remembered position, incremented by the item's thickness along the direction.

Stacking is complete when the stack height is more than some defined number, or when a sensor gives a signal.

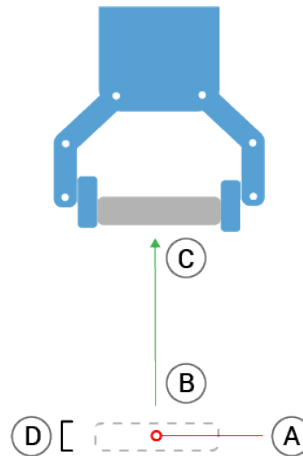
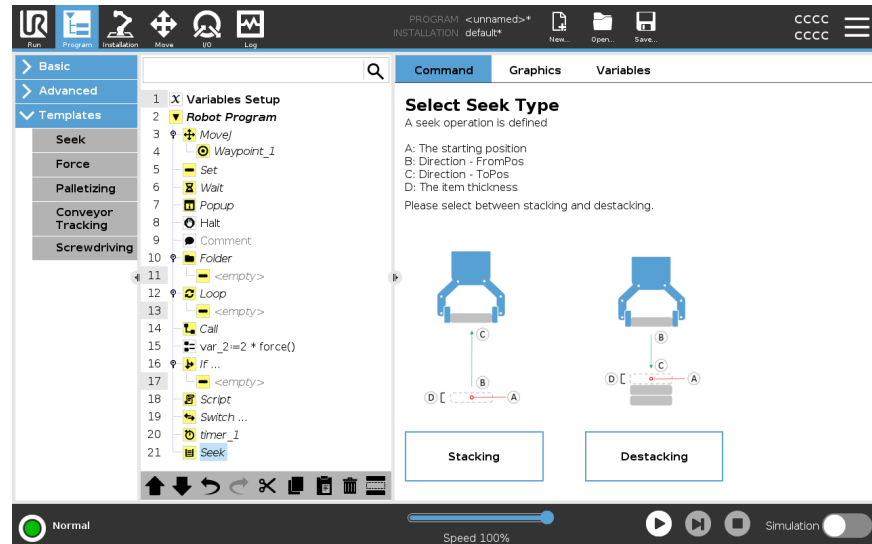

Destacking

During Destacking, the robot arm moves from point A in the given direction to search for the next item. The condition on the screen determines when the next item is reached. When the condition is satisfied, the robot remembers the position and performs the special sequence.

In subsequent rounds, the robot starts the search from the remembered position, incremented by the item's thickness along the direction.

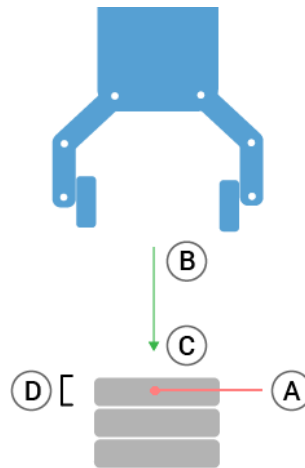
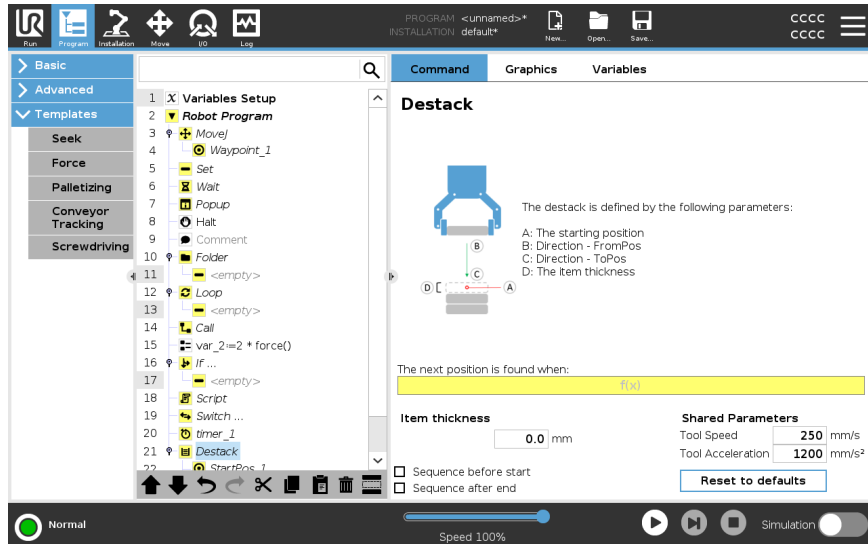

Starting position

The starting position is where the stack operation starts. If the starting position is omitted, the stack starts at the robot arm's current position.

Copyright © 2009-2024 by Universal Robots A/S. All rights reserved.

Direction

The direction, given by positions *B* to *C*, is calculated as the position difference from the TCP of *B* to the TCP of *C*.

Direction does not consider the orientations of the points.

Next Stacking Position Expression

The robot arm moves along the direction vector while continuously evaluating whether the next stack position has been reached. When the expression is evaluated to `True` the special sequence is executed.

“BeforeStart”

The optional `BeforeStart` sequence is run just before the operation starts. This can be used to wait for ready signals.

“AfterEnd”

The optional `AfterEnd` sequence is run when the operation is finished. This can be used to signal conveyor motion to start, preparing for the next stack.

Pick/Place Sequence

The Pick/Place Sequence is a special program sequence performed at each stack position, similar to the Pallet operation.

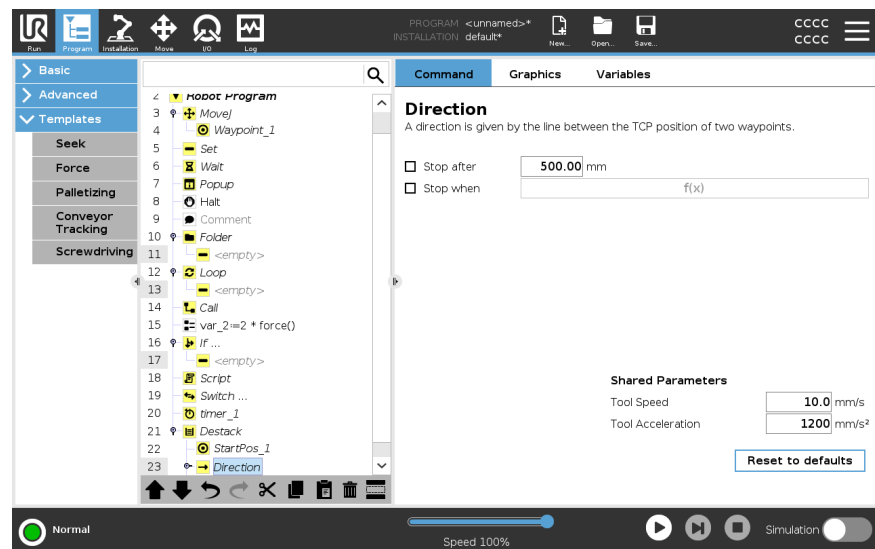

19.9.2. Force

Description

Force mode is suited to applications where the actual TCP position along a predefined axis is not important, but instead a desired force along that axis is required. For example, if the robot TCP rolls against a curved surface, pushes or pulls a workpiece.

Force mode also supports applying certain torques around predefined axes. The robot arm attempts to accelerate along that axis, if no obstacles are met in an axis where a non-zero force is set. Although an axis is selected to be compliant, the robot program still tries to move the robot along that axis. However, force control assures that the robot arm still approaches the specified force.



NOTICE

Using this function at the same time as Conveyor Tracking and/or Path Offset can lead to program conflict.

- Do not use this function together with Conveyor Tracking or Path Offset.



NOTICE

If there is a Force node inside an If, ElseIf or Loop, and the `Check Expression Continuously` option is selected, you can add an `end_force_mode()` script at the end of the expression to exit force control.



WARNING

1. Avoid high deceleration just before entering force mode.
2. Avoid high acceleration in force mode, since it decreases force control accuracy.
3. Avoid movements parallel to compliant axes before entering force mode.

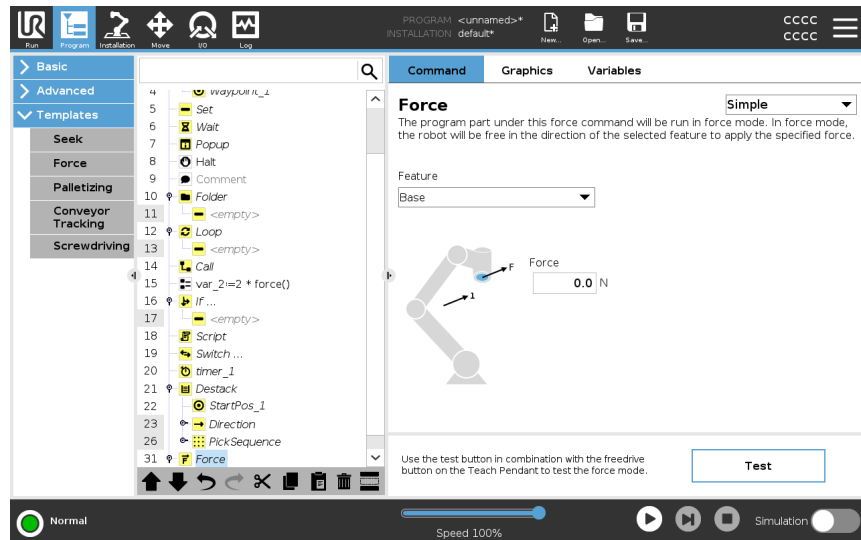

Feature selection The **Feature** menu is used to select the coordinate system (axes) the robot will use while it is operating in force mode. The features in the menu are those which have been defined in the installation.

Force mode type The types of force mode, listed below, determine how the selected feature is interpreted.

- **Simple:** Only one axis will be compliant in force mode. The force along this axis is adjustable. The desired force will always be applied along the z-axis of the selected feature. However, for Line features, it is along their y-axis.
- **Frame:** The Frame type allows for more advanced usage. Here, compliance and forces in all six degrees of freedom can be independently selected.
- **Point:** When Point is selected, the task frame has the y-axis pointing from the robot TCP towards the origin of the selected feature. The distance between the robot TCP and the origin of the selected feature is required to be at least 10 mm. The task frame changes at runtime as the position of the robot TCP changes. The x- and z-axis of the task frame are dependent on the original orientation of the selected feature.
- **Motion:** Motion means that the task frame will change with the direction of the TCP motion. The x-axis of the task frame will be the projection of the TCP movement direction onto the plane spanned by the x- and y-axis of the selected feature. The y-axis will be perpendicular to the robot arm's motion, and in the x-y plane of the selected feature. This can be useful when de-burring along a complex path, where a force is needed perpendicular to the TCP motion.

When the robot arm is not moving: If force mode is entered with the robot arm standing still, there will be no compliant axes until the TCP speed is above zero. If later, while still in force mode, the robot arm is again standing still, the task frame has the same orientation as the last time the TCP speed was larger than zero.

For the last three types, the actual task frame can be viewed at runtime on the graphics tab (see), when the robot is operating in force mode.

Force value selection

- Force or torque value can be set for compliant axes, and robot arm adjusts its position to achieve the selected force.
- For non-compliant axes robot arm will follow the trajectory set by the program.

For translational parameters, the force is specified in Newtons [N] and for rotational the torque is specified in Newton meters [Nm].



NOTICE

You must do the following:

- Use `get_tcp_force()` script function in separate thread, to read actual force and torque.
- Correct wrench vector, if actual force and/or torque is lower than requested.

Speed limits

Maximum Cartesian speed can be set for compliant axes. The robot moves at this speed in force control, as long as it does not come into contact with an object.

Test force settings

The on/off button, labelled **Test**, toggles the behavior of the **Freedrive** button on the back of the Teach Pendant from normal Freedrive mode to testing the force command. When the **Test button** is on and the **Freedrive** button on the back of the Teach Pendant is pressed, the robot will perform as if the program had reached this force command, and this way the settings can be verified before actually running the complete program. Especially, this possibility is useful for verifying that compliant axes and forces have been selected correctly. Simply hold the robot TCP using one hand and press the **Freedrive** button with the other, and notice in which directions the robot arm can/cannot be moved.

Upon leaving this screen, the Test button automatically switches off, which means the **Freedrive** button on the back of the Teach Pendant is again used for regular **Freedrive** mode.

The **Freedrive** button is only effectual when a valid feature is selected for the Force command.

19.9.3. Palletizing

Description

Palletizing is a template to easily program palletizing and depalletizing tasks, picking-and-placing parts (i.e., from trays, fixtures, etc.), and having the robot perform repeatable actions for different items in multiple layers with different patterns. You can create different patterns and apply them to specific layers. You can also place a separator between each layer (see).

Furthermore, you can use Features from Pallet Properties to easily adjust the placement of your pallet.

To learn about Features, see

Follow the **Creating a Palletizing Program** section below to use the Palletizing template.

Creating a Palletizing Program

1. Decide if you want to teach a Feature (see) or use a Base as a reference plane.
2. In the **Program Tab**, under **Templates**, tap **Palletizing**.
3. On the Palletizing screen, select one of the following actions depending on the desired action.
 1. Select **Palletizing** to organize items onto a pallet.
 2. Select **Depalletizing** to remove items from a pallet.
4. Under **Pallet Properties**, specify the Name, Feature (see Step 1), Object Height, and Item Counter name for your program. Select the **Remember last item location** box if you want the robot to restart at the item it was handling when it stopped.
5. On the Palletizing screen, under **Actions**, add additional actions to be performed before or after palletizing sequence by selecting the following:
 1. **Add Action Before Palletizing**: These actions are performed before starting to palletize.
 2. **Add Action After Palletizing**: These actions are performed after finishing palletizing.
6. On the Program Tree, tap the **Patterns** node to designate patterns for your layers. You can create the following type of patterns: Line, Grid, or Irregular (see figure below). On this screen, you can select if you want to include a separator between layers (see).
7. Tap the pattern node(s) on the Program Tree to teach the robot layer-specific positions (e.g., start/end points, grid corners, and/or number of items). See for teaching instructions. All positions must be taught at the bottom of the pallet. To duplicate a pattern, tap the **Duplicate pattern** button on the Pattern node screen that you wish to duplicate.
8. In the Program Tree, tap the **Layers** node to configure the layers of your palletizing sequence. Use the **Choose Pattern** drop-down menu to select the pattern for each layer. Tap the **Add layer** button to add additional layers to your program. Layers must be added in the correct order, as they cannot be reordered later.

Creating a Palletizing Program

- In the Program Tree, tap **At Each Item** node. Choose to use the default option (A) At Each Item Wizard, or (B) Manually Configure At Each Item. Instructions for each option are below.

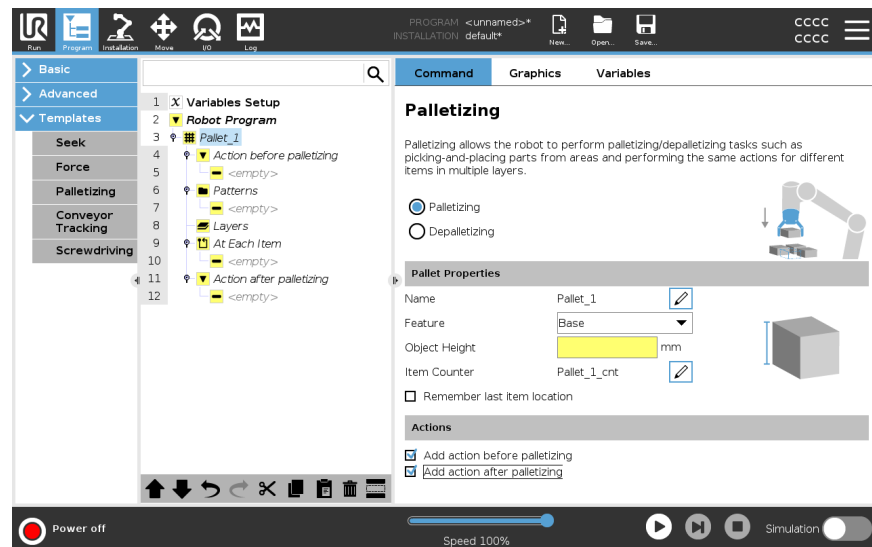

At Each Item Wizard

The At Each Item Wizard assists in defining the actions performed at each item on a pallet, such as the ReferencePoint, the Approach Waypoint, ToolActionPoint Waypoint, and Exit Waypoint (described in the table below). The Approach and Exit Waypoints for each item remains in the same orientation and direction regardless of the different items' orientation.

- Tap the **At Each Item** node on the Program Tree.
- On the At Each Item screen, tap **Next**.
- Tap the **Move Here** button. Then, hold the **Auto** button or use the **Manual** button to move the robot to the ReferencePoint. Tap the **Continue** button. Tap **Next**.
- Tap **Set Waypoint** to teach the Approach Waypoint (see). Tap **Next**.
- Repeat Step 3.
- Tap **Set Waypoint** to teach the Exit Waypoint (see). Tap **Next**.
- Tap **Finish**.
- You can now add appropriate gripper action nodes in the Tool Action folder in the Program Tree.

Manual Configuration

1. Tap the **At Each Item** node on the Program Tree.
2. On the **At Each Item** start screen, tap **Manual Configuration**.
3. Use the drop-down menus to select a Pattern and a ReferencePoint item. Tap the **Use this ReferencePoint** button to set the ReferencePoint.
4. Move the robot to the ReferencePoint by tapping **Move Here**.
5. Tap the Approach node in the Program Tree to teach the robot the Approach Waypoint (see). The Approach Waypoint remains in the same orientation and direction regardless of the different items' orientation.
6. Tap the At Each Item node in the Program Tree. Repeat Step 4.
7. Tap the **Exit** node in the Program Tree to teach the robot the Exit Waypoint (see).
8. You can now add appropriate gripper action nodes in the Tool Action folder in the Program Tree.

Adding a Separator Between Layers in a Palletizing Sequence

Separators, such as paper or Styrofoam, can be placed between layers in a palletizing sequence. To add separators between layers, follow the instructions below:

1. On the Program Tree, select the **Patterns** node.
2. On the **Patterns** screen, select **Separator** and define the height using the **Separator Height** text box. If the height is not defined, the program will not run.
3. Select **Layers** in the Program Tree. On the Layers screen, select which layers you want the separators to go between (separators are automatically placed between each layer).
4. Tap the **Separator** node in the Program Tree. Tap **Set Separator** to teach the Separator Position.
5. Choose between using the default option (A) Separator Wizard, or (B) Manually Configure the Separator sequence. Instructions for each option are below.

When the wizard is complete, or if you cancel the wizard, a template appears in the Program Tree under **Separator Action**. In addition to the Tool Action folder under the Separator Action node, you can select one of the following folders:

- **Pick Up Separator** to program the robot to pick up separators for palletizing
- **Drop Off Separator** to drop off separators for depalletizing

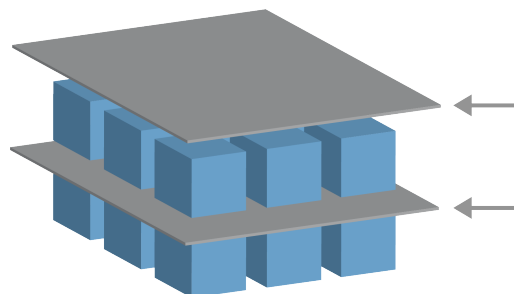

(A) Separator Wizard

1. Tap the **Separator Action** node on the Program Tree.
2. On the Separator Action screen, tap **Next**.
3. Tap the **Move Here** button and hold the **Auto** button or use the **Manual** button to move the robot to the Separator Point. Tap the **Continue** button. Tap **Next**.
4. Tap **Set Waypoint** to teach the Approach Waypoint (see). Tap **Next**.
5. Repeat Step 3.
6. Tap **Set Waypoint** to teach the Exit Waypoint (see). Tap **Next**.
7. Tap **Finish**.
8. You can now add appropriate action nodes in the Pick Up Separator, Drop Off Separator, and Tool Action folders in the Program Tree.

(B) Manual Configuration

1. Tap the **Separator Action** node on the Program Tree.
2. On the **Separator Action** start screen, tap **Manual Configuration**.
3. Move the robot to the Separator Point by tapping **Move to Separator Point**.
4. Tap the Approach node in the Program Tree to teach the robot the Approach Waypoint (see).
5. Tap the Separator Action node in the Program Tree. Repeat Step 3.
6. Tap the Exit node in the Program Tree to teach the robot the Exit Waypoint (see).
7. You can now add appropriate action nodes in the Pick Up Separator, Drop Off Separator, and Tool Action folders in the Program Tree.

Options to Customize A Palletizing Program

You can customize your palletizing program in the following ways:

- If your pallet needs to be adjusted or re-positioned after you have created a palletizing program, you only need to re-teach the pallet Feature (see) because the palletizing sequence is fixed relative to the Feature. Thus, all other program components automatically adjust to the newly taught position.
- You can edit the properties of the move commands (see).
- You can change the speeds and blends radii (see).
- You can add other program nodes to the At Each Item sequence or the Separator Action sequence.

Positions

Line



To teach the positions, select each item in the Program Tree:

- StartItem1
- EndItem1

Insert the number of items in your sequence using the **Items** text box at the bottom of the screen.

Grid



To teach the positions, select each item in the Program Tree:

- CornerItem1
- CornerItem2
- CornerItem3
- CornerItem4

Insert the number of rows and columns in the appropriate text boxes to set the dimensions of the pattern.

Irregular



To teach the positions, select each item in the Program Tree:

- Item1
- Item2
- Item3

Tap **Add Item** to add and identify a new item in the sequence.

Actions

Tool Action Point

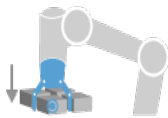

The location and position you want the robot to be in when conducting an action for each item in a layer. The ToolActionPoint Waypoint is the ReferencePoint by default, but it can be edited in the Program Tree by tapping the ToolActionPoint Waypoint node. When using the wizard, the ReferencePoint is the first position in the first defined layer on the pallet. The ReferencePoint is used to teach the robot the Approach Waypoint, ToolActionPoint Waypoint, and Exit Waypoint for each item in a layer.

Approach

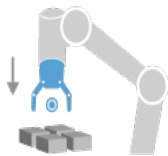

The collision-free position and direction you want the robot to take when approaching an item in a layer.

Tool Action

The action you want the robot attachment to perform for each item.

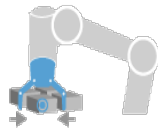

Exit Waypoint The position and direction you want the robot to take when moving away from an item in a layer.

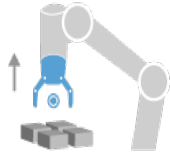

19.9.4. Conveyor Tracking

Description

Conveyor Tracking allows the Robot Arm to track the movement of up to two conveyors. Conveyor Tracking is defined in the Installation Tab.



NOTICE

Using this function at the same time as Force and/or Path Offset can lead to a program conflict.

- Do not use this function together with Force or Path Offset.

The Conveyor Tracking program node is available in the Program Tab under Templates. All movements under this node are allowed while tracking the conveyor, but they are relative to the motion of the conveyor belt. Blends are not allowed when exiting Conveyor Tracking, so the robot stops completely before making the next motion.

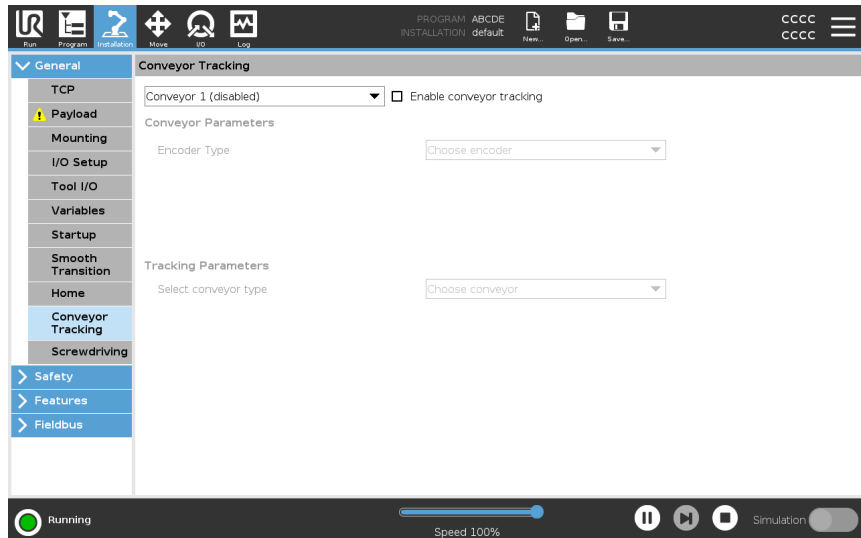

Tracking a Conveyor

1. In the Header, tap **Program**.
2. Tap **Templates** and select **Conveyor Tracking** to add a Conveyor Tracking node to the Program Tree. Any movements listed under the Conveyor Tracking node tracks the movement of the conveyor.
3. Under Conveyor Tracking, in the Select Conveyor dropdown list, select **Conveyor 1** or **Conveyor 2** to define which conveyor must be tracked.



NOTICE

If there is a Conveyor Tracking node inside an If, ElseIf or Loop, and the Check Expression Continuously option is selected, you can add an `end_conveyor_tracking()` script at the end of the expression to exit conveyor tracking.

19.9.5. Screwdriving

Description

The **Screwdriving** program node provides an easy way to add a screwdriving application for an attached screwdriver. Configuring the screwdriver and its connections to the robot is defined in the Installation Tab (see [General](#)).

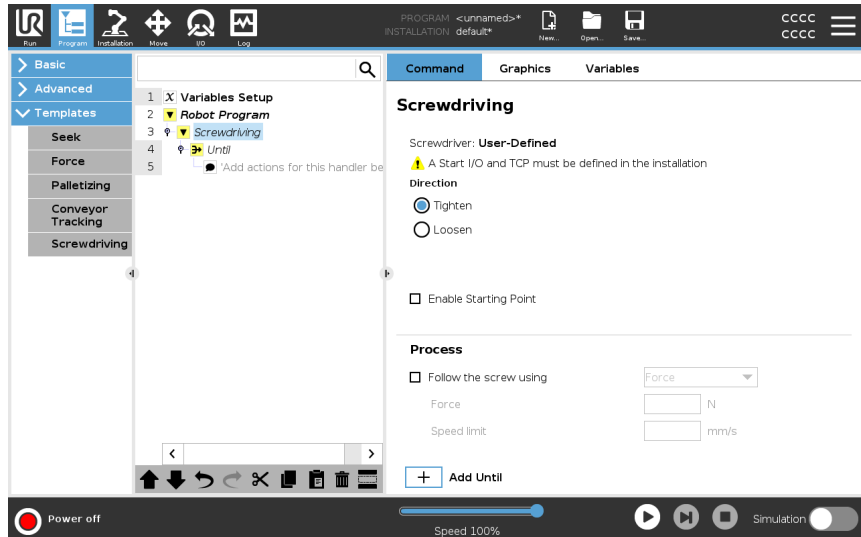

Adding a Screwdriving Node

1. In the Header, tap **Program**.
2. Under Templates, tap **Screwdriving**.
3. Select **Tighten** to follow the screw in a tightening direction (in), or select **Loosen** to follow the screw in a loosening direction (out). This selection only impacts the motion of the robot to follow the screw and its measuring calculations.
4. In the **Program Selection** field, you can select a screwdriver program, depending on the **Program Selection** signals in the Installation.
5. Select **Enable Starting Point**, to add a MoveL to the Program Tree that is executed when the screwdriver is already running. Select **Enable Machine Error Handler**, to add a corrective measure, if required, to the Program Tree before the screwdriving actions begins.

Affect screwdriving action

Selecting **Follow the Screw**, under **Process**, to affect the screwdriving action in the following ways:

- **Force:** Select **Force** to define how much force is exerted on a screw. Then select **Speed Limit**, so the robot moves at this speed as long as it does not come into contact with the screw.



CAUTION

Place the screwdriver bit above the screw before starting a screwdriving program. Exerting any force on the screw can affect the screwdriving program performance.

- **Speed:** Select a fixed **Tool Speed** and **Acceleration** for the robot to follow the screw.
- **Expression:** Similar to the If command (see [19.8.4 If on page 237](#)), select **Expression** to describe the condition under which the robot follows the screw.

Screwdrive Until

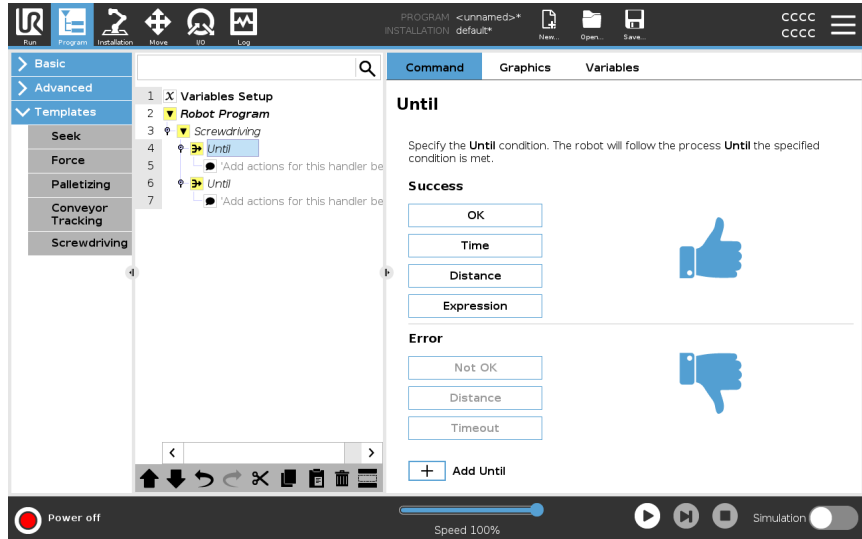
Description The Screwdriving program node includes a mandatory until success **Until** node that defines stop criteria for the screwdriving process.



You can define the following stop criteria:

- **Success:** Screwdriving continues until completion is detected using your selected option. You can only add one success condition.
- **Error:** Screwdriving continues until an error is detected using your selected option/s. You can add more than one error condition.

Criteria

Success



- **OK:** Screwdriving continues until an OK signal from the screwdriver is detected.
- **Time:** Screwdriving continues upto a defined time.
- **Distance:** Screwdriving continues upto a defined distance.
- **Expression:** Screwdriving continues until a custom expression condition is met.

Error



- **Not OK:** Screwdriving stops when a NOT OK signal from the screwdriver is detected.
- **Distance:** Screwdriving stops when the defined distance is exceeded.
- **Timeout:** Screwdriving stops when the defined time is exceeded.

19.10. URCaps

Description

The Remote TCP and Toolpath URCap allows you to set Remote Tool Center Points (RTCP), where the tool center point is fixed in space, relative to the base of the robot. The Remote TCP and Toolpath URCap also allows for programming waypoints and circle moves, and generating robot motion based on imported toolpath files defined in third-party CAD/CAM software packages.

The Remote TCP URCap requires your robot to be registered before use (see [Robot Registration and License file on page 338](#)). The RTCP works in applications that require the robot to grasp and move items, relative to a fixed tool. The RTCP is used together with the RTCP_MoveP and RTCP_CircleMove commands to move a grasped part with constant speed, relative to the fixed tool.

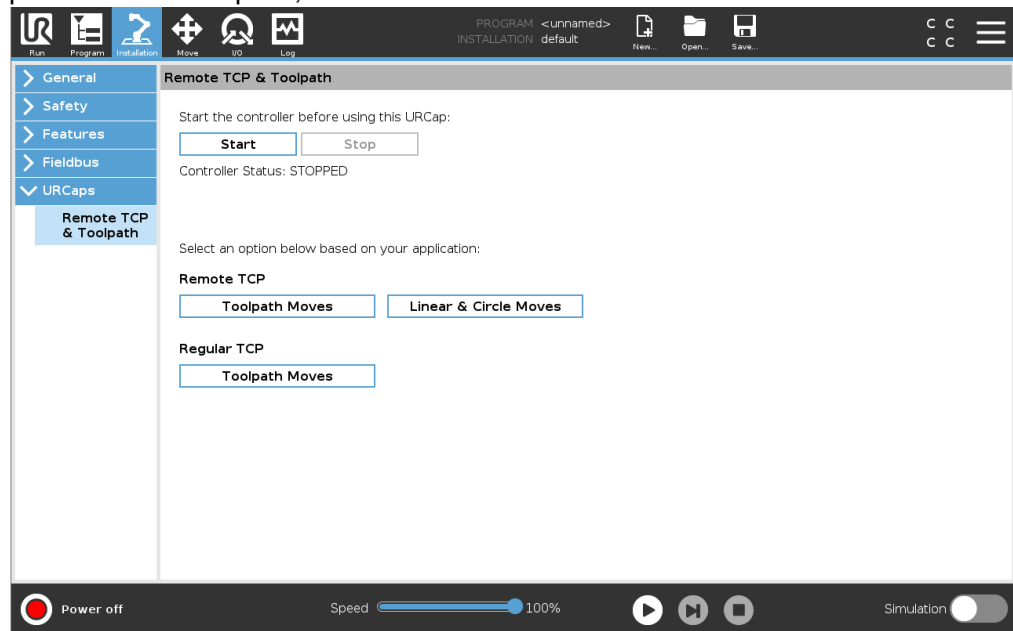

Similar to a regular TCP (see) you can define and name an RTCP in the Installation Tab's Setup.

You can also complete the following actions:

- Add, rename, modify, and remove RTCPs
- Understand the default and active RTCP
- Teach RTCP position
- Copy RTCP orientation

Setting the Remote TCP from a Feature

Set an RTCP using a Feature to allow the robot to be jogged relative to the RTCP while creating RTCP Waypoints and RTCP Circle Moves.

1. Tap the plus icon to create a new RTCP **RTCP**. Or select an existing RTCP in the drop-down menu.
2. Tap the **Copy values from a point feature** drop-down menu and select a Feature. Verify the RTCP orientation values update to match that of the selected Feature.

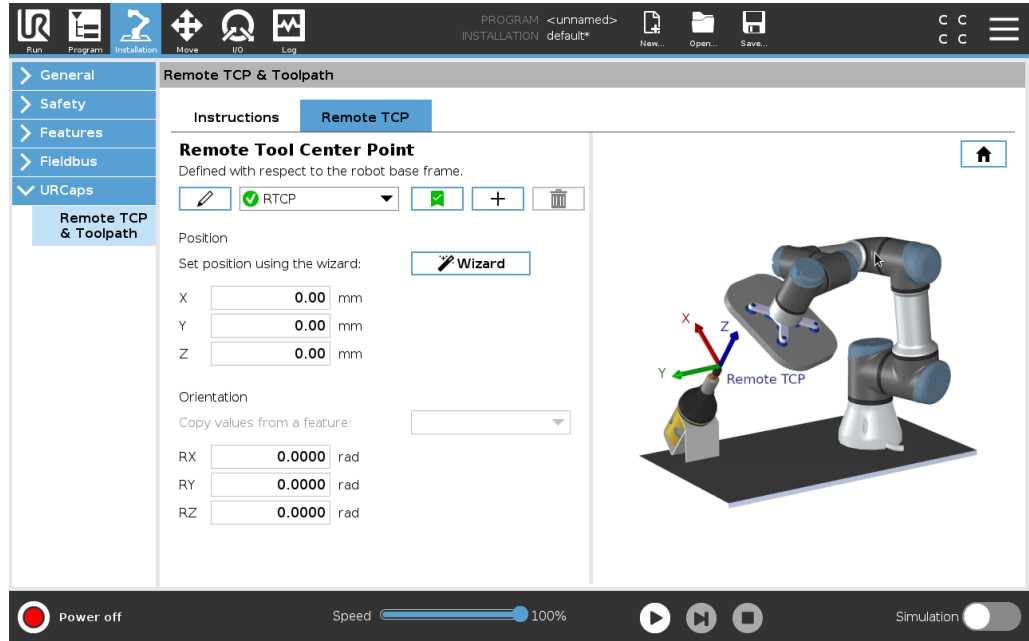

Remote TCP Movement Types

RTCP_MoveP

Similar to a regular MoveP, the RTCP_MoveP defines the tool speed and acceleration the Robot Arm moves relative to the Remote TCP. See .

RTCP Circle move

Similar to a regular Circle move, the RTCP Circle move can be added to an RTCP_MoveP to make circular movements. See .



NOTICE

The maximum speed of a Circle Move may be lower than the specified value. The circle radius is r , the maximum acceleration is A , and the maximum speed cannot exceed Ar due to centripetal acceleration.

Remote TCP Waypoint

Similar to regular waypoints, RTCP Waypoints allow a tool to move linearly using constant speed and circular blends. The default blend radius size is a shared value between all the waypoints. A smaller blend radius size sharpens the path turn. A larger blend radius size smoothens the path. RTCP Waypoints are taught by physically moving the Robot Arm to a desired position.

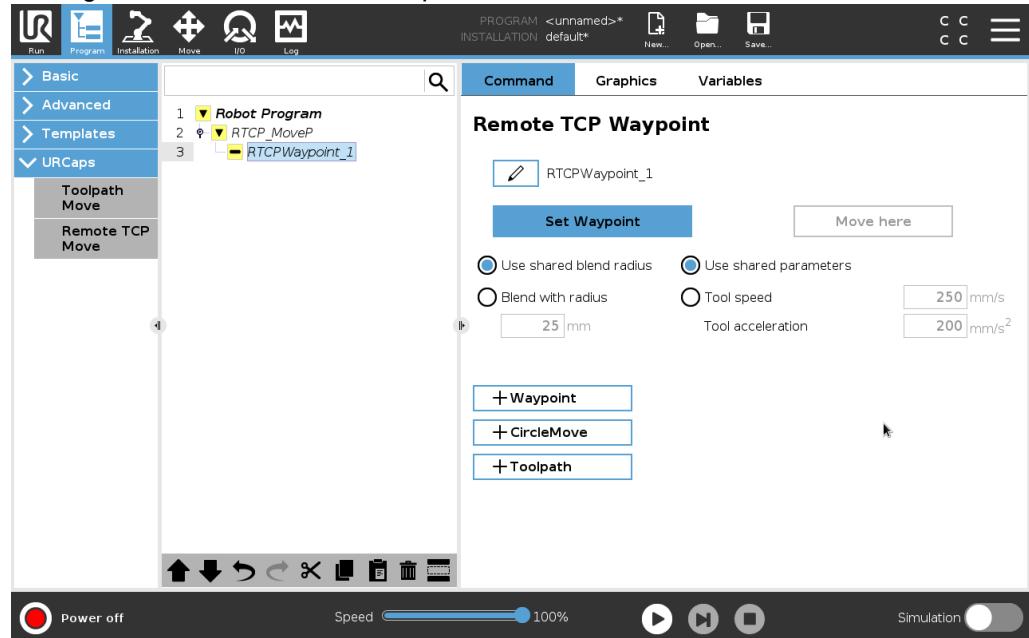

Teaching Remote TCP Waypoints

1. In the Program Tab, insert an **RTCP_MoveP** node.
2. On the RTCP_MoveP node, tap **Set** to bring up the Move screen.
3. On the Move screen, use **Teach Mode** or **Jog** to position the robot in a desired configuration.
4. Tap the green check mark to validate.

Configuring an RTCP Waypoint

Use blends to enable the robot to smoothly transition between two trajectories. Tap **Use Shared Blend Radius** or tap **Blend with radius** to set the blend radius for a waypoint from an RTCP_MoveP.



NOTICE

A physical time node (e.g. Move, Wait) cannot be used as a child of an RTCP_MoveP node. If an unsupported node is added as a child to an RTCP_MoveP node, the program fails to validate.

Remote TCP Toolpath

The Remote TCP and Toolpath URCap generates robots motions automatically, making it easier to follow complex trajectories accurately.

Configuring a Remote TCP Toolpath

1. Select **Remote TCP Toolpath Moves** on the Remote TCP & Toolpath URCap Home Page to enter the workflow.
2. Follow the instructions under the **Instructions Tab**.

A Remote TCP Toolpath Move requires the following major components:

- Toolpath file
- Remote TCP
- Remote TCP PCS

Configuring a Toolpath using CAD/CAM Software

A toolpath defines the orientation, trajectory, speed or (feed rate) and travel direction of the tool.

1. Create or import a CAD model of a part.
2. Set up a Part Coordinate System (PCS) fixed to the part.
3. Create a toolpath relative to the PCS based on part features
4. Simulate the toolpath motion to verify it meets expectation.
5. Export the toolpath into a G-code file with .nc file extension.

Importing a G-code Toolpath into PolyScope

1. Load the toolpath files in the root directory of a USB stick. Toolpath files must have the .nc extension
2. Insert the USB stick into the Teach Pendant.
3. In the Header, tap Installation, tap URCaps, select Remote TCP & Toolpath, select Remote TCP - Toolpath Moves, and select Toolpath.
4. Select which toolpath files to import into Polyscope.

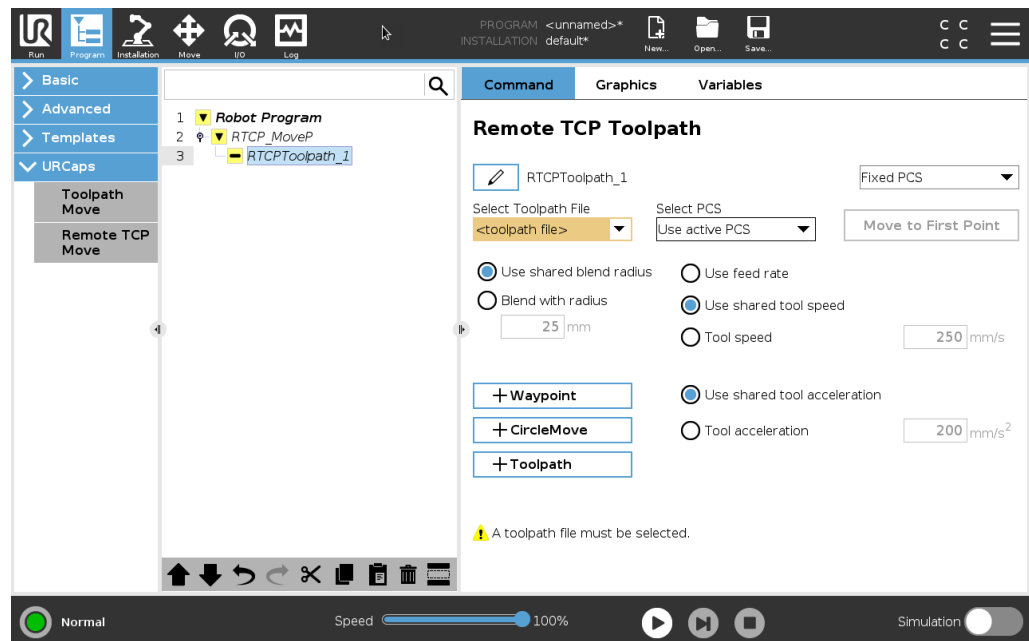

Remote TCP

Configuring a Remote TCP for Toolpath Moves

1. At the first waypoint in the CAM environment, determine the tool orientation.
2. Use Freedrive to manually grasp the part with the gripper.
3. Select the location of the Remote TCP
4. Use the position wizard to obtain the positive values.
5. Adjust the robot until the desired part pose for approaching the remote TCP is achieved.
6. Envision the tool orientation at the first waypoint on the physical part. The positive Z-axis direction should point away from the part surface.
7. Create a Plane Feature with the same orientation as envisioned in the previous step.
8. Set the Remote TCP orientation by copying values from the Plane Feature. The desired part pose is maintained while the toolpath is executed.

Remote TCP PCS

The Remote TCP Part Coordinate System (PCS) is defined as fixed relative to the robot tool flange. Tap the wand, on the PolyScope screen, to activate the wizard to teach the Remote TCP PCS. You can use either of the teaching methods described below.

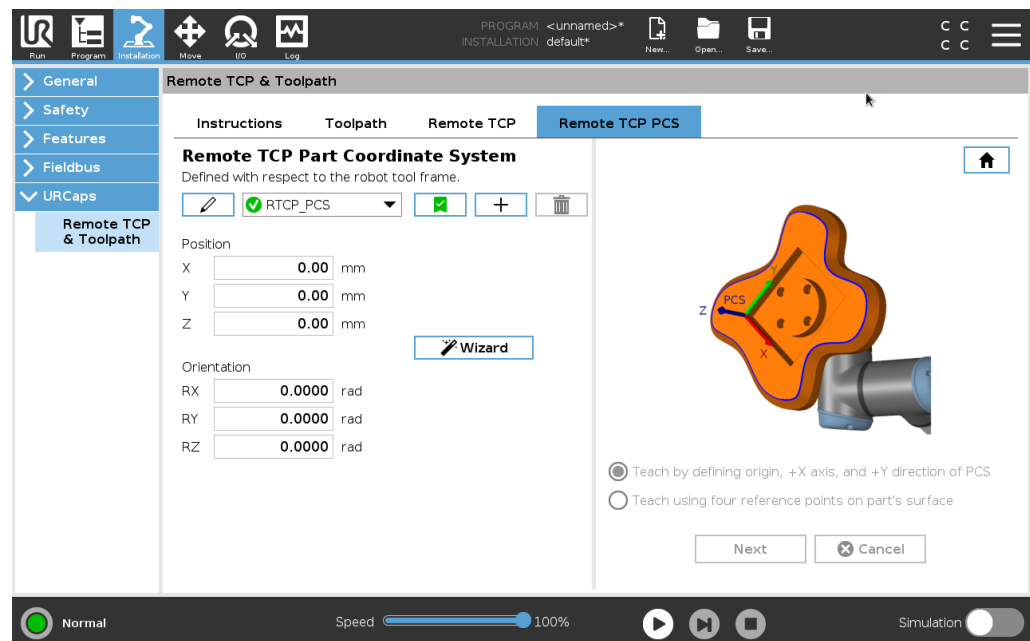

Configuring a Remote TCP PCS

Use this method if the PCS can be set on the part surface.

1. Use freedrive to manually grasp the part with the gripper.
2. Select a Remote TCP to teach the reference points. For high accuracy, temporarily set up a sharp Remote TCP to complete this teaching process.
3. Jog the robot for the Remote TCP to touch the origin, positive X-axis and the positive Y-axis direction of the PCS on the part.
4. Tap Set to conclude the teaching process. The position and orientation values are populated automatically.

Otherwise, use this method.

1. Select three or four reference points on the part surface.
 2. In the CAD/CAM software, record the X, Y, Z coordinates, relative to the PCS of the selected reference points.
 3. Use freedrive to manually grasp the part with the gripper.
 4. Select a Remote TCP to teach the reference points. For high accuracy, temporarily set up a sharp Remote TCP to complete this teaching process.
 5. Enter the coordinates for the first reference point.
 6. Jog the robot for the Remote TCP to touch the first reference point on the part.
 7. Repeat steps five and six for the other reference points.
-

Setting a Variable PCS

For advanced use cases, where the part is not grasped with high consistency, you can set a Variable PCS to adjust the toolpath moves according to the part location and orientation relative to the robot tool flange.

You can create a pose variable tied to an external sensor that can detect the PCS location and orientation.

1. Set up an external sensor that detects the PCS location and orientation. You must convert the sensor output to the robot tool flange frame.
 2. Verify the PCS is set up relative to the part and the location and orientation are detectable by the external sensor.
 3. In PolyScope, create a pose variable tied to the external sensor output as a variable PCS. Give it a distinct name, for example, **variable_rtcp_pcs_1**.
 4. Insert an **RTCP Toolpath Node**.
 5. At the top right corner of the program page, in the drop-down menu, select **Variable PCS**.
 6. In the **Select PCS** drop-down menu, select **variable_rtcp_pcs_1**.
 7. Create an Assignment or Script node to update **variable_rtcp_pcs_1** before the RTCP Toolpath Node.
-

Configuring a Remote TCP Toolpath Node

The following section explains how to use a variable PCS in a Remote TCP Toolpath node.

1. Access the Program Tab and tap **URCaps**.
2. Select **Remote TCP Move** to insert an `RTCP_MoveP` node.
3. Select a TCP and set the motion parameters: tool speed, tool acceleration and blend radius.
4. Tap **+Toolpath** to insert an `RTCPToolpath` node. Delete the `RTCPWaypoint` node that was created by default, if it is not needed.
5. Select a toolpath file and the corresponding Remote TCP PCS from the drop-down menus.
6. Adjust the motion parameters if different values are to be applied to the `RTCPToolpath` node.
7. Tap **Move to First Point** to verify the grasped part approaches the Remote TCP as expected.
8. Test the program in the simulation mode at a low speed to confirm the configurations.

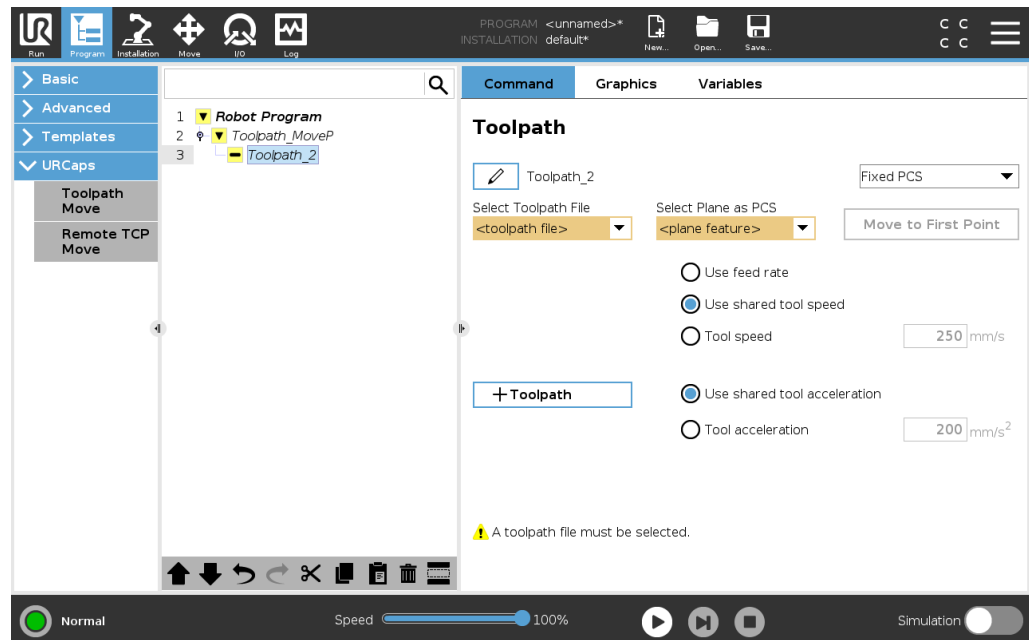

NOTICE

You can ensure the robot motion is identical, each time the toolpath is executed, by adding a MoveJ with a **Use Joint Angles** set to move to a fixed joint configuration before executing the toolpath. See [19.7.1 Move](#) on page 191

Regular TCP Toolpath Moves

Similar to configuring a Remote TCP Toolpath Move, a regular TCP Toolpath Move requires the following:

- Toolpath file
- Regular TCP
- Plane Feature as a PCS

Configuring and Importing a Toolpath File

This is similar to configuring a Toolpath (see [Configuring a Toolpath using CAD/CAM Software on page 268](#)) and importing Toolpath (see [Importing a G-code Toolpath into PolyScope on page 268](#)).

Configuring a Regular TCP

- Follow the instructions to configure a Regular TCP.
- Verify the positive Z-axis of the tool points away from the part surface.

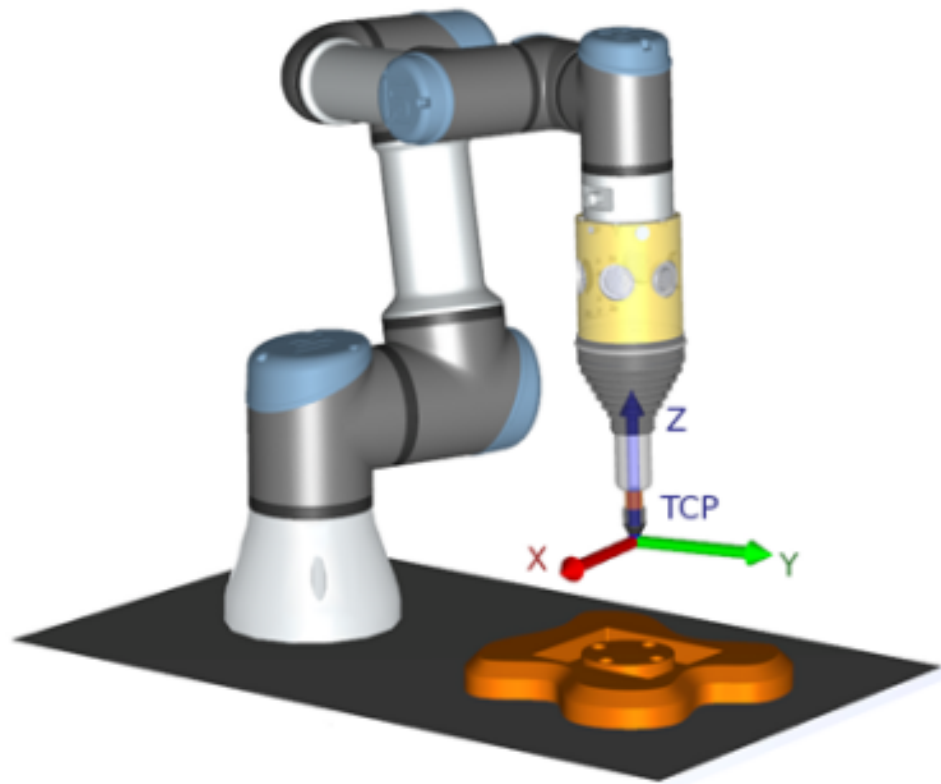

Configuring a Plane Feature PCS

1. Create a plane feature by **Adding a plane** or **Teaching a plane**. See .
2. Fix the part relative to the robot base.
3. Verify the correct TCP is used to create the plane feature. For high accuracy, temporarily set up a sharp Remote TCP to complete this teaching process.
4. Jog the robot for the Remote TCP to touch the origin, positive X-axis and the positive Y-axis direction of the PCS on the part.
5. Finish the teaching process and confirm the PCS position and orientation.

Configuring a Toolpath Node

1. Access the Program Tab and tap **URCaps**.
2. Select a TCP and set the motion parameters: tool speed, tool acceleration and blend radius. Select **Spin tool freely around its Z-axis**. Do not select if the tool must follow the orientation around Z-axis defined in the toolpath file.
3. Tap **+Toolpath** to insert a Toolpath node.
4. In the drop-down menu, select a toolpath file and the corresponding PCS (Plane Feature).
5. Adjust the motion parameters if different values are to be applied to the Toolpath node.
6. Tap **Move to First Point** to verify the tool can move to the first point of the toolpath.
7. Run the program in the simulation mode, at a low speed, to confirm the configurations are correct.



NOTICE

You can ensure the robot motion is identical, each time the toolpath is executed, by adding a MoveJ with a **Use Joint Angles** set to move to a fixed joint configuration before executing the toolpath. See [19.7.1 Move](#) on page 191

20. Installation Tab

Description The Installation Tab allows you to configure the settings which affect the overall performance of the robot and PolyScope.

20.1. TCP Configuration

Description A **Tool Center Point (TCP)** is a point on the robot's tool. Each TCP contains a translation and a rotation relative to the center of the tool output flange. When programmed to return to a previously stored waypoint, a robot moves the TCP to the position and orientation saved within the waypoint. When programmed for linear motion, the TCP moves linearly.

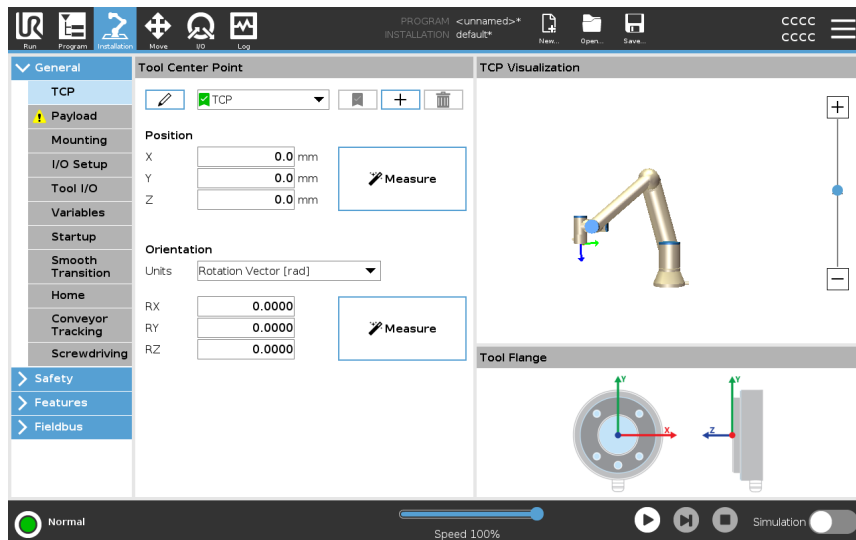



Position The X, Y, Z coordinates specify the TCP position. When all values (including orientation) are zero, the TCP coincides with the center point of the tool output flange and adopts the coordinate system depicted on the screen.

Orientation The RX, RY, RZ coordinate boxes specify the TCP orientation. Similar to the Move Tab, use the Units drop down menu above the RX, RY, RZ boxes to select the orientation coordinates

Adding, Renaming, Modifying and Removing TCPs

You can start configuring a new TCP with the following actions:

- Tap the  to define a new TCP with a unique name. The new TCP is available in the dropdown menu.
- Tap the  to rename a TCP.
- Tap the  to remove a selected TCP. You cannot remove the last TCP.

Active TCP

When moving linearly, the robot always uses the active TCP to determine the TCP offset. The active TCP can be changed using a Move command (see [19.2.2 Command Tab on page 178](#)) or a Set command. The motion of the active TCP is visualised on the Graphics Tab (see [19.2.3 Graphics Tab on page 181](#)).

Default TCP

The Default TCP must be set as the active TCP before running a program.

- Select the desired TCP and tap **Set as default** to set a TCP as the default.

The green icon in the available drop-down menu indicates the default configured TCP.

20.1.1. Teaching TCP Position

Teaching TCP orientation

TCP position coordinates can be calculated automatically as follows:

1. Tap **Measure**.
2. Choose a fixed point in the workspace of the robot.
3. Use the position arrows on the right side of the screen to move the TCP from at least three different angles and to save the corresponding positions of the tool output flange.
4. Use the **Set** button to apply the verified coordinates to the appropriate TCP. The positions must be sufficiently diverse for the calculation to work correctly. If they are not sufficiently diverse, the status LED above the buttons turns red.

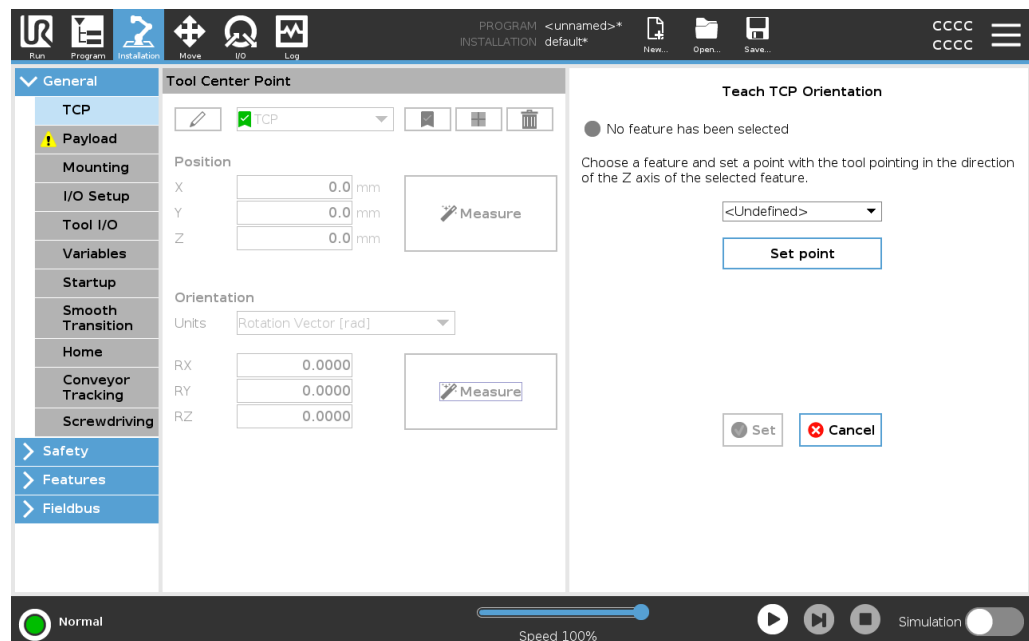

Though three positions are sufficient to determine the TCP, a fourth position can be used to further verify the calculation is correct. The quality of each saved point, with respect to the calculated TCP, is indicated using a green, yellow, or red LED on the corresponding button.

1. Tap **Measure**.
2. Select a feature from the drop-down list. (See [20.13 Features on page 295](#)) for additional information on defining new features
3. Tap **Set point** and use **Move tool arrows** to a position where the tool's orientation and the corresponding TCP coincide with the selected features's coordinate system.
4. Verify the calculated TCP orientation and apply it to the selected TCP by tapping **Set**.

20.2. Payload

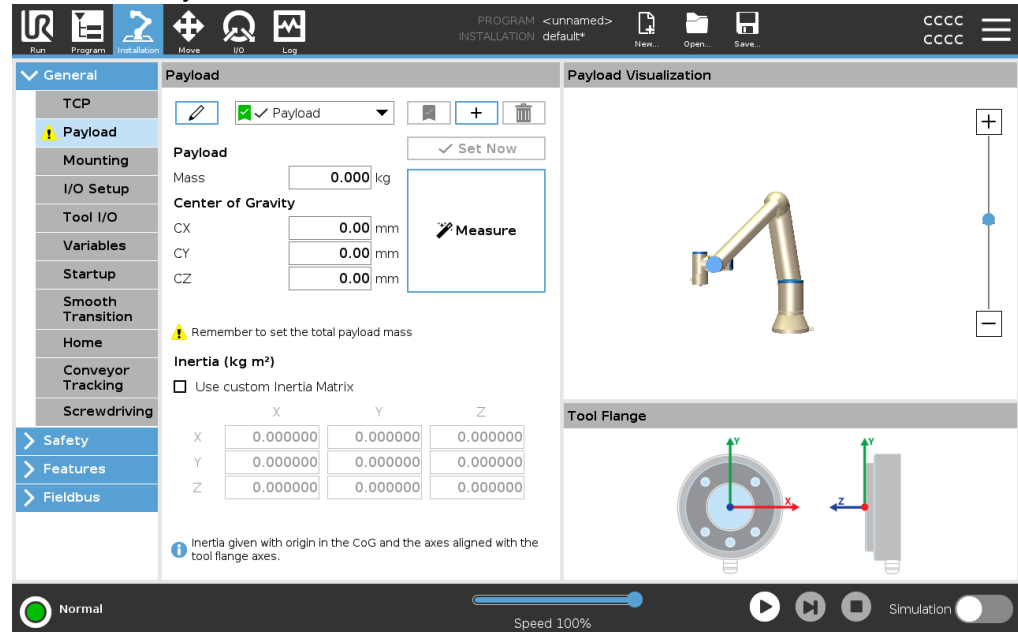

Description

You must set the Payload, the CoG and the inertia for the robot to perform optimally. You can define multiple Payloads, and switch between them in your program. This is useful in Pick and Place applications, for example, where the robot picks up and releases an object.





Adding, Renaming, Modifying and Removing Payloads

You can start configuring a new Payload with the following actions:

- Tap the  to define a new Payload with a unique name. The new payload is available in the drop-down menu.
- Tap the  to rename a Payload.
- Tap the  to remove a selected Payload. You cannot remove the last Payload.

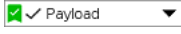
Active Payload

The checkmark in the drop-down indicates which payload is active . The active Payload can be changed using the .

Default Payload

The default Payload is set as the active Payload before the program starts.

- Select the desired Payload and tap **Set as default** to set a Payload as the default.

The green icon in the drop-down menu indicates the default configured Payload

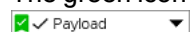

Setting the Center of Gravity

Tap the fields CX, CY and CZ to set the center of gravity. The settings apply to the selected Payload.



Payload Estimation

This feature allows the robot to help set the correct Payload and Center of Gravity (CoG).

Using the Payload Estimation Wizard

1. In the Installation Tab, under General, select **Payload**.
2. On the Payload screen, tap **Measure**.
3. In the Payload Estimation Wizard tap **Next**.
4. Follow the steps in the Payload Estimation Wizard to set the four positions. Setting the four positions requires moving the robot arm into four different positions. The load of the payload is measured at each position.
5. Once all measurements are complete, you can verify the result and tap **Finish**.



NOTICE

Follow the these guidelines for best Payload Estimation results:

- Ensure the TCP positions are as different as possible from each other
 - Perform the measurements within a short timespan
 - Avoid pulling on the tool and/or attached payload before and during estimation
 - Robot mounting and angle must be correctly defined in the installation
-

Setting Inertia Values

You can select **Use custom Inertia Matrix** to set inertia values.

Tap the fields: I_{XX} , I_{YY} , I_{ZZ} , I_{XY} , I_{XZ} and I_{YZ} to set the inertia for the selected Payload.

The inertia is specified in a coordinate system with the origin at the Center of Gravity (CoG) of the payload and the axes aligned with the tool flange axes.

The default inertia is calculated as the inertia of a sphere with the user specified mass, and a mass density of 1g/cm^3

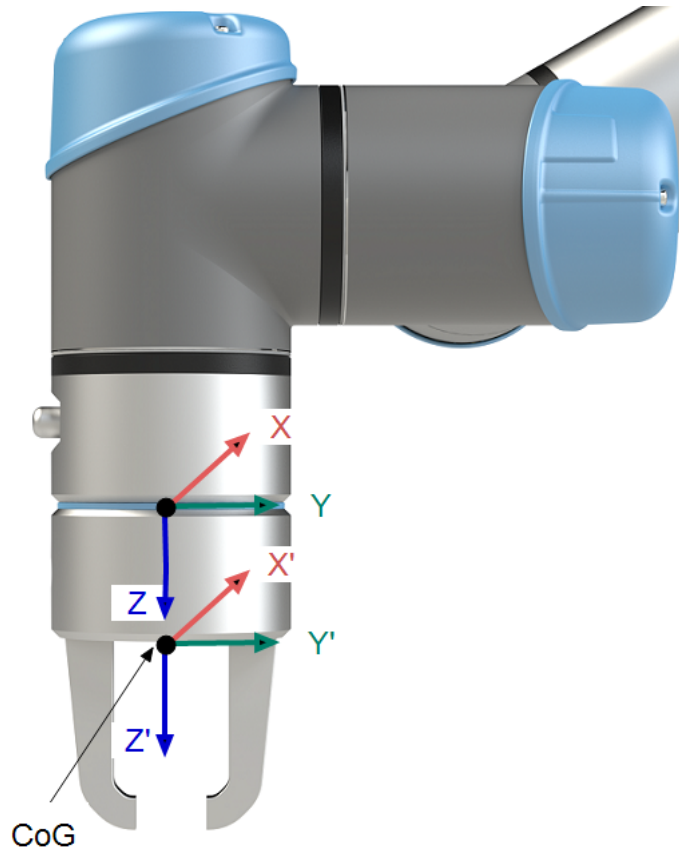

20.3. Mounting

Description

Specifying the mounting of the Robot arm serves two purposes:

1. Making the Robot arm appear correctly on screen.
2. Telling the controller about the direction of gravity.

An advanced dynamics model gives the Robot arm smooth and precise motions, as well as allows the Robot arm to hold itself in **Freedrive Mode**. For this reason, it is important to mount the Robot arm correctly.



WARNING

Failure to mount the Robot's arm correctly may result in frequent robot stops, and/or the Robot arm will move when pressing the **Freedrive** button.

If the Robot arm is mounted on a flat table or floor, no change is needed on this screen. However, if the Robot arm is **ceiling mounted**, **wall mounted**, or **mounted at an angle**, this needs to be adjusted using the buttons.

The buttons on the right side of the screen are for setting the angle of the Robot arm's mounting. The top three right side buttons set the angle to **ceiling** (180°), **wall** (90°), **floor** (0°). The **Tilt** buttons set an arbitrary angle.

The buttons on the lower part of the screen are used to rotate the mounting of the Robot arm to match the actual mounting.



WARNING

Use the correct installation settings. Save and load the installation files with the program.

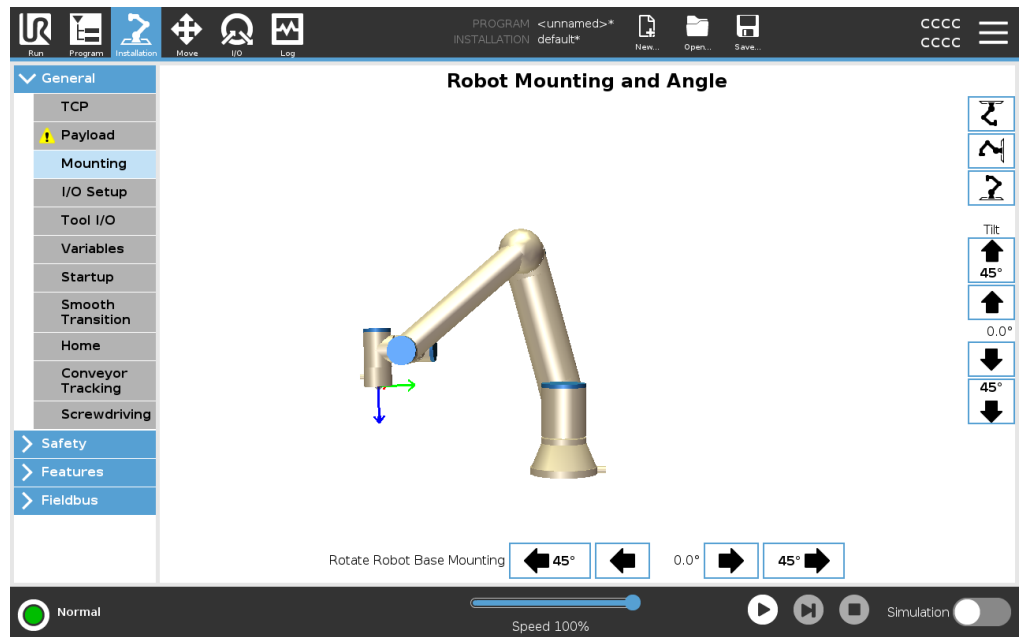

20.4. I/O Setup

Description Use the I/O Setup screen to define I/O signals and configure actions with the I/O tab control. The types of I/O signals are listed under **Input** and **Output**. You can use a fieldbus, for example, Profinet and EtherNet/IP, to access the general purpose registers. If you enable the Tool Communication Interface (TCI), the tool analog input becomes unavailable.

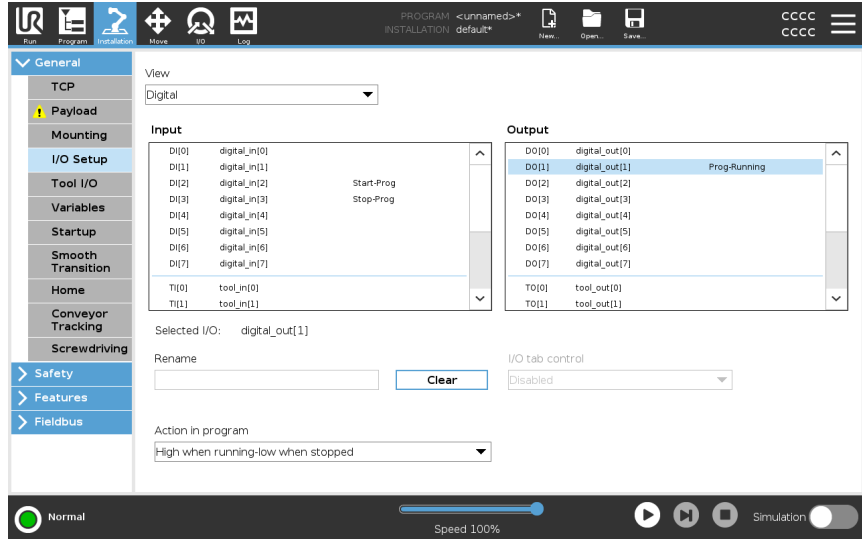

I/O Signal Type To limit the number of signals listed under **Input** and **Output**, use the **View** drop-down menu to change the displayed content based on signal type.

Assigning User-defined Names You can name the Input and Output signals to easily identify the ones being used.

1. Select the desired signal.
2. Tap the text field to type a name for the signal.
3. To reset the name to default, tap **Clear**.

You must provide a user-defined name for a general purpose register to make it available in the program (i.e., for a **Wait** command or the conditional expression of an **If** command).

The **Wait** and **If** commands are described in (19.7.4 Wait on page 220) and (19.8.4 If on page 237), respectively. You can find named general purpose registers in the **Input** or **Output** selector on the **Expression Editor** screen.

I/O Actions and I/O Tab Control You can use Physical and Fieldbus digital I/Os to trigger actions or react to the status of a program.

I/O Tab Control Use I/O Tab Control to specify whether an output is controlled on the I/O tab (by either programmers, or both operators and programmers), or if it is controlled by the robot programs.

Available Input Actions	Action	Action
	Start	Starts or resumes the current program on a rising edge (only enabled in Remote Control, see 25.2 Settings on page 334)
	Stop	Stops the current program on a rising edge
	Pause	Pauses the current program on a rising edge
	Freedrive	When the input is high, the robot goes into freedrive (similar to the freedrive button). The input is ignored if other conditions disallow freedrive.

WARNING

If the robot is stopped while using the Start input action, the robot slowly moves to the first waypoint of the program before executing that program. If the robot is paused while using the Start input action, the robot slowly moves to the position from where it was paused before resuming that program.

Available Output Actions	Action	Output state	Program state
	Low when not running	Low	Stopped or paused
	High when not running	High	Stopped or paused
	High when running, low when stopped	Low High	Running Stopped or paused
	Low on unscheduled stop	Low	Program terminated unscheduled
	Low on unscheduled stop, otherwise High	Low High	Program terminated unscheduled Running, stopped or paused

Alternates between high and low

Running
(pause or stop
the program to
maintain the
pulse state)

Continuous Pulse

Program Termination Cause



NOTICE

A program is terminated unscheduled if any of the following occur:

- Robot stop
- Fault
- Violation
- Runtime exception

20.5. Installation Variables

Description

Variables created on the **Installation Variables** pane are called installation variables and are used like normal program variables. Installation variables are distinct because they keep their value even if a program stops then starts again, and when the robot arm and/or Control Box is powered down and powered up again.

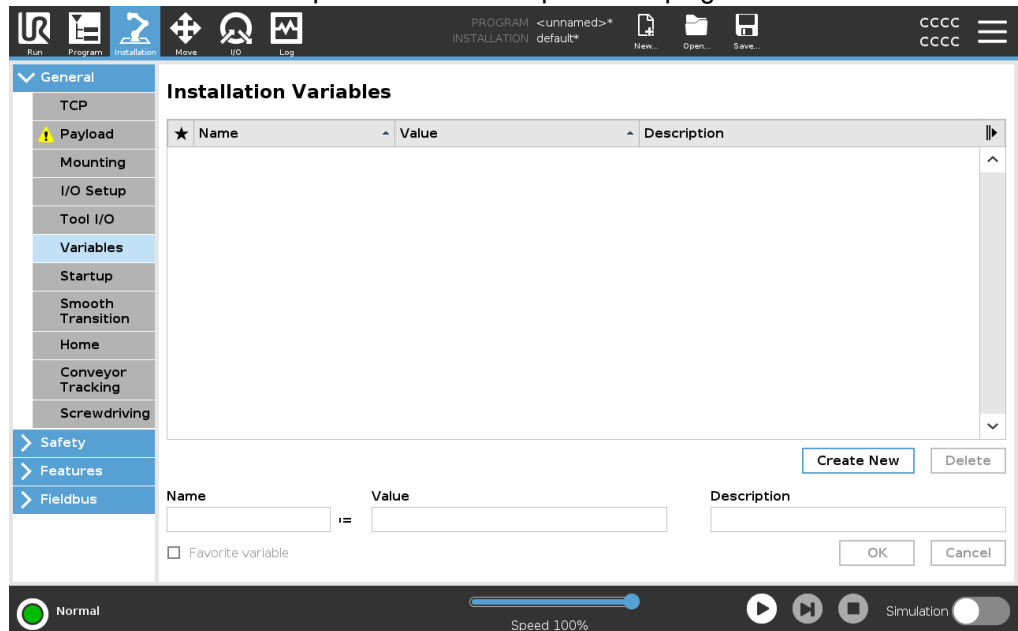

Creating installation variables

Installation variable names and values are stored with the installation, so you can use the same variable in multiple programs.
Installation variables and their values are saved automatically every 10 minutes during program execution, also when the program is paused and when it is stopped.

To create an installation variable

1. Tap **Create New** and a new variable name is suggested in the **Name** field.
You can edit the variable name as desired.
2. In the **Value** field, set a value for the new variable.
You cannot save a variable without first setting the Value.
3. You can describe the new installation variable in the **Description** field.
4. You can set the new variable as favorite by checking the **Favorite variable** box.
5. Tap **OK** to add the new variable to the Installation Variables list.

Designating favorite installation variables

Designating a favorite installation variable allows the installation variable to be part of the set of favorite variables displayed when you select it to only show favorite variables on the Variables tab in the Program Tab screen and on the Run Tab screen.

To designate an installation variable as favorite

1. In the Header, tap **Installation**.
2. Under General, select **Variables**.
The variables are listed under **Installation Variables**.
3. Select the desired variables.
4. Check the **Favorite variable** box.
5. Tap **Run** to return to your variable display.

Managing installation variables

To edit installation variables

1. Select the desired variable in the Installation Variables list.
2. You can edit the **Value**, the **Description**, or the **Favorite variable**.
You cannot edit the variable name in this step.

Changes to edited installation variables take immediate effect.

To delete installation variables

1. Select the desired variable and tap **Delete**.
2. Select **Delete Variable** in the confirmation pop-up



Variable descriptions

You can add information to your variables by adding variable descriptions in the Description column. You can use the variable descriptions to convey the purpose of the variable and/or the meaning of its value to operators using the Run tab screen and/or other programmers.

Variable descriptions (if used) can be up to 120 characters, displayed in the Description column of the variables list on the Run tab screen and the Variables tab screen.

A variable description spans multiple lines to fit the width of the Description column if necessary. You can also collapse and expand the Description column by using the buttons shown below.

To collapse/expand the Description column

1. Tap **Collapse**  to collapse the Description column.
 2. Tap **Expand**  to expand the Description column.
-

20.6. Startup

Description The Startup screen contains settings for automatically loading and starting a default program, and for auto-initializing the Robot arm during power up.

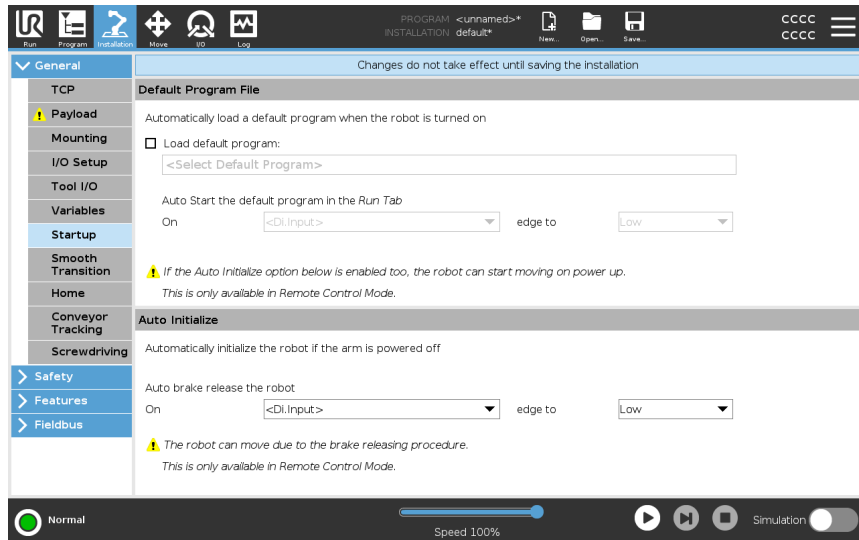

WARNING

1. When autoload, auto start and auto initialize are enabled, the robot runs the program as soon as the Control Box is powered up as long as the input signal matches the selected signal level. For example, the edge transition to the selected signal level will not be required in this case.
2. Use caution when the signal level is set to LOW. Input signals are low by default, leading the program to automatically run without being triggered by an external signal.
3. You must be in **Remote Control Mode** before running a program where auto start and auto initialize are enabled.

Loading a Startup Program

A default program is loaded after the Control Box is powered up. Furthermore, the default program is auto loaded when the **Run Program** screen (see [18 Run Tab on page 165](#)) is entered and no program is loaded.

Starting a Startup Program

The default program is auto started in the **Run Program** screen. When the default program is loaded and the specified external input signal edge transition is detected, the program is started automatically.

On Startup, the current input signal level is undefined. Choosing a transition that matches the signal level on startup starts the program immediately. Furthermore, leaving the **Run Program** screen or tapping the Stop button in the Dashboard disables the auto start feature until the Run button is pressed again.

20.7. Tool I/O

Description

The I/O Interface Control allows you to switch between user control and URcap control.



I/O Interface Control

1. Tap the Installation tab and under General, tap Tool I/O
2. Under I/O Interface Control, select User to access the Tool Analog Inputs and/or Digital Output Mode settings. Selecting a URcap removes access to the Tool Analog Inputs and the Digital Output Mode settings.



NOTICE

If a URcap controls an end-effector, such as a gripper, then the URcap requires control of the Tool IO Interface. Select the URcap in the list, to allow it to control the Tool IO Interface.

20.7.1. Analog Input - Communication Interface

Description

The Tool Communication Interface (TCI) enables the robot to communicate with an attached tool via the robot tool analog input. This removes the need for external cabling.

Once the Tool Communication Interface is enabled, all tool analog inputs are unavailable

- | | |
|-------------------------------------|---|
| Tool Communication Interface | <ol style="list-style-type: none"> 1. Tap the Installation tab and under General tap Tool I/O. 2. Select Communication Interface to edit TCI settings.
Once the TCI is enabled, the tool analog input is unavailable for the I/O Setup of the Installation and does not appear in the input list. Tool analog input is also unavailable for programs as Wait For options and expressions. 3. In the drop-down menus under Communication Interface, select required values. Any changes in values are immediately sent to the tool. If any installation values differ from what the tool is using, a warning appears. |
|-------------------------------------|---|
-

20.7.2. Digital Output Mode

Description

The tool communication interface allows two digital outputs to be independently configured. In PolyScope, each pin has a drop-down menu that allows the output mode to be set. The following options are available:

- **Sinking:** This allows the pin to be configured in an NPN or Sinking configuration. When the output is off, the pin allows a current to flow to the ground. This can be used in conjunction with the PWR pin to create a full circuit.
- **Sourcing:** This allows the pin to be configured in a PNP or Sourcing configuration. When the output is on, the pin provides a positive voltage source (configurable in the IO Tab). This can be used in conjunction with the GND pin to create a full circuit.
- **Push / Pull:** This allows the pin to be configured in a Push / Pull configuration. When the output is on, the pin provides a positive voltage source (configurable in IO Tab). This can be used in conjunction with the GND pin to create a full circuit. When the output is off, the pin allows a current to flow to the ground.

After selecting a new output configuration, the changes take effect. The currently loaded installation is modified to reflect the new configuration. After verifying the tool outputs are working as intended, make sure to save the installation to prevent losing changes.

Dual Pin Power

Dual Pin Power is used as a source of power for the tool. Enabling Dual Pin Power disables default tool digital outputs.

20.8. Smooth Transition

Description When switching between safety modes during events (i.e., Reduced Mode Input, Reduced Mode Trigger Planes, Safeguard Stops, and Three-Position Enabling Device), the Robot Arm aims to use 0.4s to create a "soft" transition. Existing applications have unchanged behavior which corresponds to the "hard" setting. New installation files default to the "soft" setting.

- Adjusting Acceleration/Deceleration Settings**
1. In the Header, tap **Installation**.
 2. In the In the Side Menu on the left, under **General**, select **Smooth Transition**.
 3. Select **Hard** to have a higher acceleration/deceleration or select **Soft** for the smoother default transition setting.

20.9. Home

Description Home is a user-defined return position for the Robot Arm. Once defined, the Home Position is available when creating a robot program. You can use the Home Position to define a Safe Home Position. (See [17.9 Safe Home Position on page 163](#)) Use the Home screen buttons for the following:

- **Edit Position** modifies a Home Position.
- **Move here** moves the Robot Arm to the defined Home Position.
- **Zero Position** returns the Robot Arm to an upright position.

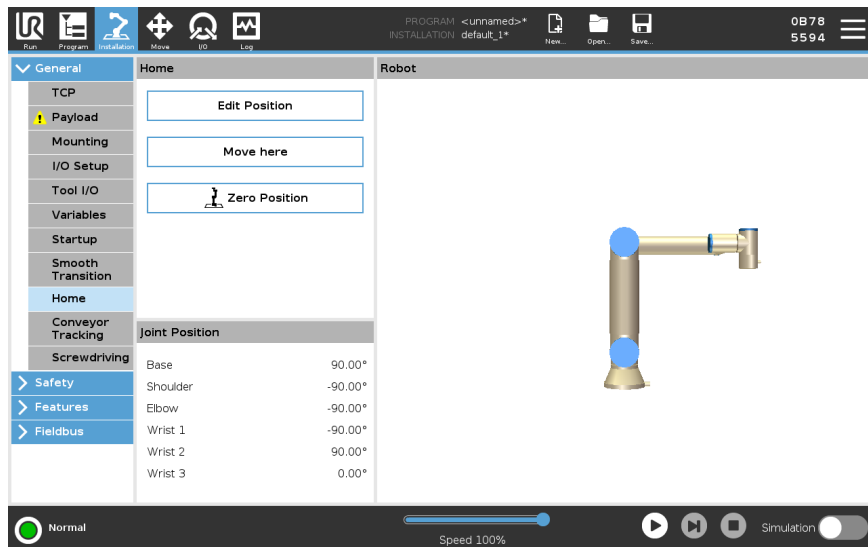

Defining Home

1. In the Header, tap **Installation**.
2. Under **General**, select **Home**.
3. Tap **Set Position**.
4. Teach robot using either **Freedrive** or **Transition** buttons.

20.10. Conveyor Tracking Setup

Description

The Conveyor Tracking Setup allows the movement of up to two separate conveyors to be configured. The Conveyor Tracking Setup provides options for configuring the robot to work with absolute or incremental encoders, as well as linear or circular conveyors.

Defining a Conveyor

1. In the Header, tap **Installation**.
2. Under **General**, select **Conveyor Tracking**.
3. Under **Conveyor Tracking Setup**, in the dropdown list select **Conveyor 1** or **Conveyor 2**.
You can only define one conveyor at a time.
4. Select **Enable Conveyor Tracking**
5. Configure **Conveyor Parameters** and **Tracking Parameters**.

Conveyor Parameters
Incremental Encoders

These can be connected to Digital Inputs 8 to 11. Decoding of digital signals runs at 40kHz. Using a **Quadrature** encoder (requiring two inputs), the robot can determine the speed and direction of the conveyor. If the direction of the conveyor is constant, a single input can be used to detect *Rising*, *Falling*, or *Rise and Fall* edges which determine conveyor speed.

Absolute Encoders

These can be connected through a MODBUS signal. This requires a Digital MODBUS Output register preconfigured in (section).

Tracking Parameters

Linear Conveyors

When a linear conveyor is selected, a line feature must be configured in the **Features** part of the installation to determine the direction of the conveyor. Ensure accuracy by placing the line feature parallel to the direction of the conveyor, with a large distance between the two points that define the line feature. Configure the line feature by placing the tool firmly against the side of the conveyor when teaching the two points. If the line feature's direction is opposite to the conveyor's movement, use the **Reverse direction** button. The **Ticks per meter** field displays the number of ticks the encoder generates when the conveyor moves one meter.

Circular Conveyors

When tracking a circular conveyor, the conveyor center point must be defined.

1. Define the center point in the **Features** part of the installation. The value of **Ticks per revolution** must be the number of ticks the encoder generates when the conveyor rotates one full revolution.
2. Select the **Rotate tool with conveyor** checkbox for the tool orientation to track the conveyor rotation.

20.11. Screwdriving Setup

Description

The Screwdriving Setup provides options for configuring the robot to work with an industrial screwdriver or an industrial nutrunner. You can setup the screwdriver's position with respect to the robot's tool flange and electrical interface.

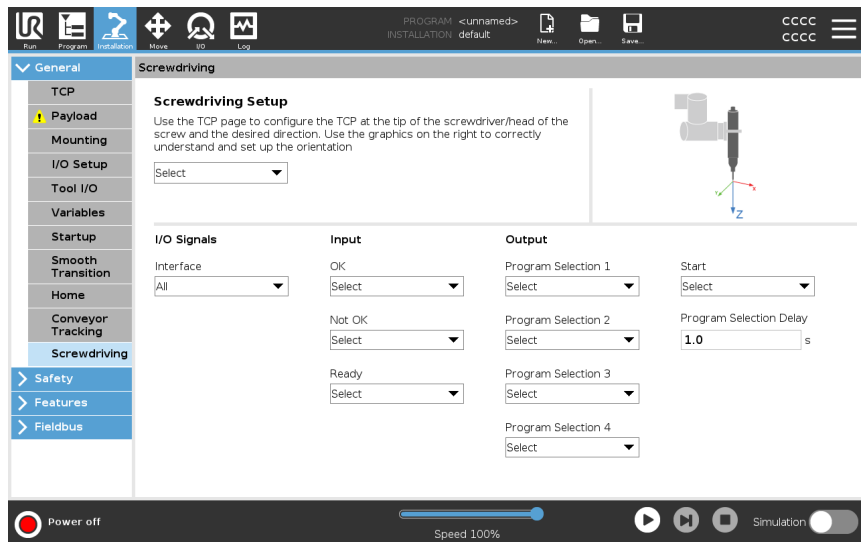

Configuring a Screwdriver

In any output Program Selection list under Output, you can select an integer output to switch Program Selection to a number field.

1. In the Header, tap **Installation**.
2. Under **General**, select **Screwdriving**, or create your own TCP for screwdriving by tapping **TCP** under **General**.
3. Under **Input** and **Output**, configure the I/Os for your screwdriver. You can use the **Interface** list to filter the type of I/Os displayed under Input and Output.
4. Under **Start**, select the I/O that starts the screwdriving action.

Configuring the Screwdriver Position

1. Under **Screwdriving Setup**, use the drop-down menu to select a previously defined TCP (see [20.1 TCP Configuration on page 274](#)) where Position and Orientation are set up as follows:
 - Configure the Position to be the tip of the screwdriver tool where it contacts the screw.
 - Configure the Orientation so that the positive Z direction is aligned to the length of the screws to be tightened.

You can visualize the X, Y and Z coordinates of the selected TCP to confirm it matches the tool's bit or socket.

The Screwdriving program node uses the positive Z direction of the selected TCP to follow the screw and calculate distances.

Configuring the Screwdriver Interface

1. Use the **Interface** drop-down menu at the top of the screen to change the displayed content based on signal type.
2. Under **Input**, configure the signals that the robot receives from the screwdriver:
 - **OK**: High when tightening ends successfully, if not selected this condition is not available in the Screwdriving program node
 - **Not OK**: High when tightening ends with errors, if not selected this condition is not available in the Screwdriving program node
 - **Ready**: High when the screwdriver is ready to be started, if not selected this condition is not checked
3. Under **Output** configure the signals that the robot sends to the screwdriver:
 - **Start**: starts the tool tightening or loosening a screw depending only on wiring.
 - **Program Selection**: one integer, or up to four binary signals, can be selected to activate different tightening configurations stored in the screwdriver
 - **Program Selection Delay**: wait time to be used after changing the screwdriver's program to make sure it is active

Typical Orientation values

Values (in Rotation Vector [rad] notation) are illustrated in the following table.

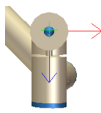
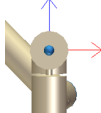
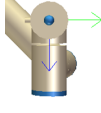
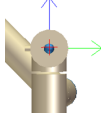
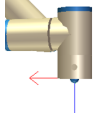
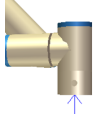
<p>Screwdriving axis parallel to the negative Y direction of the robot's tool flange1</p>		<p>Orientation</p> <ul style="list-style-type: none"> • RX: 1.5708 rad • RY: 0.0000 rad • RZ: 0.0000 rad
<p>Screwdriving axis parallel to the positive Y direction of the robot's tool flange2</p>		<p>Orientation</p> <ul style="list-style-type: none"> • RX: -1.5708 rad • RY: 0.0000 rad • RZ: 0.0000 rad
<p>Screwdriving axis parallel to the positive X direction of the robot's tool flange3</p>		<p>Orientation</p> <ul style="list-style-type: none"> • RX: 0.0000 rad • RY: 1.5708 rad • RZ: 0.0000 rad
<p>Screwdriving axis parallel to the negative X direction of the robot's tool flange4</p>		<p>Orientation</p> <ul style="list-style-type: none"> • RX: 0.0000 rad • RY: -1.5708 rad • RZ: 0.0000 rad
<p>Screwdriving axis parallel to the positive Z direction of the robot's tool flange5</p>		<p>Orientation</p> <ul style="list-style-type: none"> • RX: 0.0000 rad • RY: 0.0000 rad • RZ: 0.0000 rad
<p>Screwdriving axis parallel to the negative Z direction of the robot's tool flange6</p>		<p>Orientation</p> <ul style="list-style-type: none"> • RX: 3.1416 rad • RY: 0.0000 rad • RZ: 0.0000 rad

20.12. Safety

Description See chapter: [17 Software Safety Configuration on page 133](#).

20.13. Features

Description A **Feature** represents an object defined by a six dimensional pose (position and orientation) relative to the robot base. You can name a feature for future reference. Some subparts of a robot program consist of movements executed relative to specific objects other than the base of the robot arm. These objects can be tables, other machines, workpieces, vision systems, blanks, or boundaries existing around the robot arm.

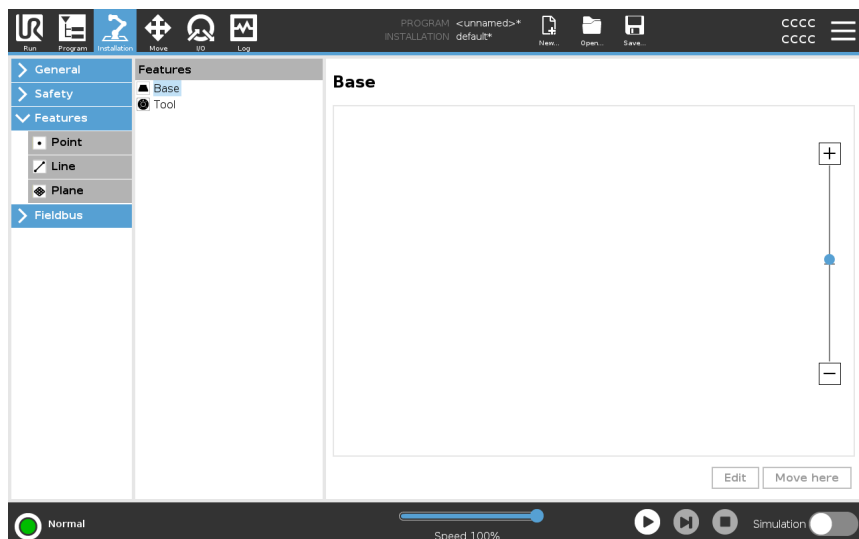

The robot includes two predefined features, listed below, with poses defined by the configuration of the robot arm itself:

- The Base feature is located with origin in the centre of the robot base.
- The Tool feature is located with origin in the centre of the current TCP.

Base feature

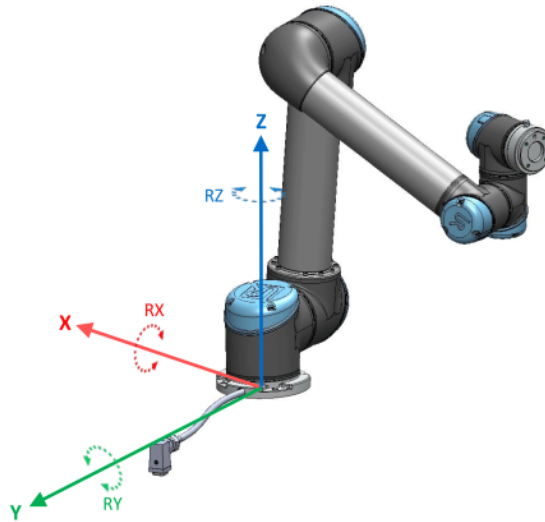

Tool feature

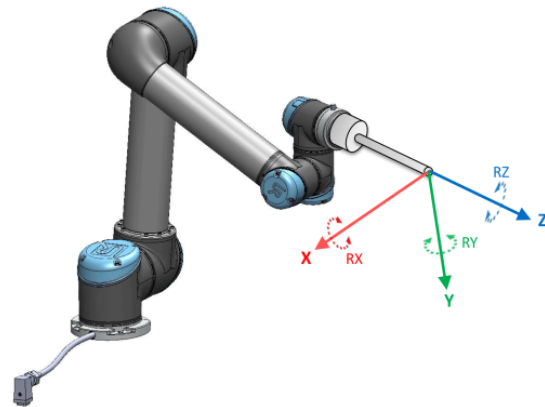

Detail

Use the Point feature, Line feature and/or Plane feature to define a feature pose. These features are positioned through a method that uses the current pose of the TCP in the work area. So you can teach feature locations using Freedrive , or "jogging" to move the robot to the desired pose. Selecting a feature depends on the type of object being used and the precision requirements. Use the Line feature and Plane feature where possible as they are based on more input points. More input points mean higher precision.

For example, you can accurately define the direction of a linear conveyor, by defining two points of a Line feature with as much physical separation as possible. You can also use the Point feature to define a linear conveyor, however, you must point the TCP in the direction of the conveyor's movement.

Using more points to define the pose of a table means that the orientation is based on the positions rather than the orientation of a single TCP. A single TCP orientation is harder to configure with high precision.

For more on adding features, see (sections: [Adding a Point on page 298](#)) and ([Plane Feature on page 299](#)).

Using a Feature You can refer to a feature defined the installation from the robot program, to relate robot movements (e.g. **MoveJ**, **MoveL** and **MoveP** commands) to the feature (see section [19.7.1 Move on page 191](#)).

This allows for easy adaptation of a robot program when for example: there are multiple robot stations, when an object is moved during program runtime, or when an object is permanently moved in the scene. Adjusting the feature of an object, adjusts all program movements relative to the object accordingly.

For further examples, see sections: ([Example: Manually Updating a Feature to Adjust a Program on page 301](#)) and ([Example: Dynamically Updating a Feature Pose on page 302](#)). When a feature is chosen as a reference, the Move Tool buttons for translation and rotation operate in the selected feature space (see [21 Move Tab on page 314](#)) and ([Move Tool on page 314](#)), reading of the TCP coordinates. For example, if a table is defined as a feature and is chosen as a reference in the Move Tab, the translation arrows (i.e., up/down, left/right, forward/backward) move the robot in these directions relative to the table. Additionally, the TCP coordinates will be in the frame of the table.

- In the Features tree you can rename a Point, Line or Plane by tapping the pencil button.
- In the Features tree you can delete a Point, Line or Plane by tapping the Delete button.

Using Move here Tap **Move here** to move the robot arm towards the selected feature. At the end of this movement, the coordinate systems of the feature and the TCP will coincide. **Move here** is disabled if the robot arm cannot reach the feature.

Point feature The point feature defines a safety boundary or a global home configuration of the Robot arm. The point feature pose is defined as the position and orientation of the TCP.

Adding a Point

1. In Installation, select **Features**.
2. Under Features select **Point**.

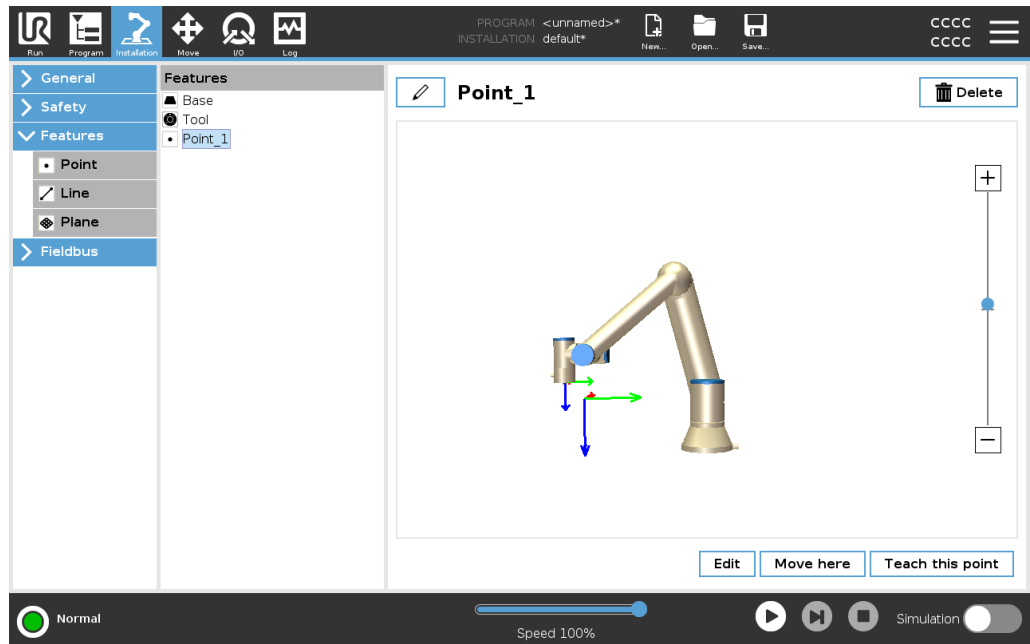

Line feature

The line feature defines lines that the robot needs to follow. (e.g., when using conveyor tracking). A line l is defined as an axis between two point features $p1$ and $p2$ as shown in figure 20.13.

Adding a Line

1. In Installation, select **Features**.
2. Under Features select **Line**.

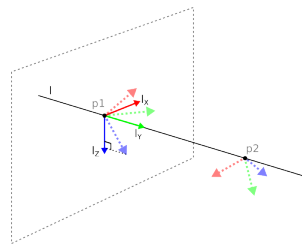
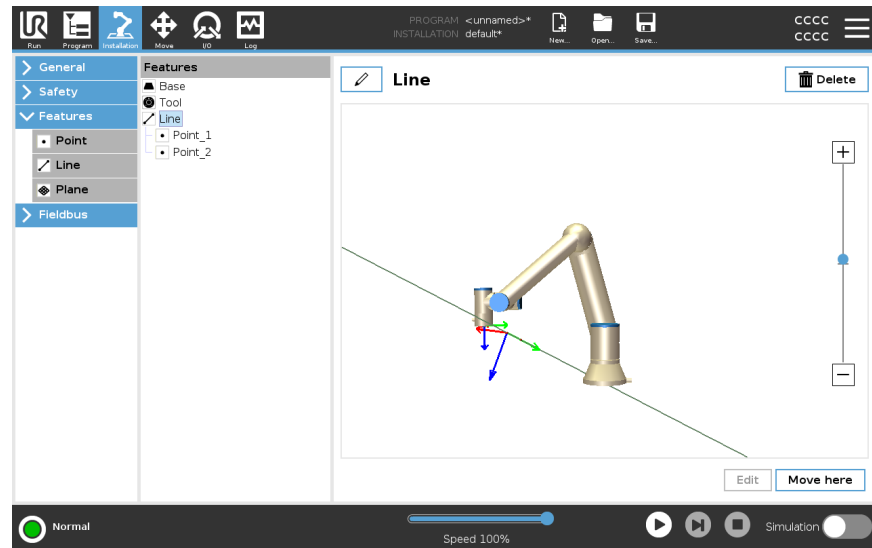

Here you can see the axis directed from the first point towards the second point, constitutes the y-axis of the line coordinate system. The z-axis is defined by the projection of the z-axis of $p1$ onto the plane perpendicular to the line. The position of the line coordinate system is the same as the position of $p1$.

Plane Feature

Select the plane feature when you need a frame with high precision: e.g., when working with a vision system or doing movements relative to a table.

Adding a plane

1. In Installation, select **Features**.
2. Under Features select **Plane**.

Teaching a plane When you press the plane button to create a new plane, the on-screen guide assists you creating a plane.

1. Select Origo
2. Move robot to define the direction of the positive x-axis of the plane
3. Move robot to define the direction of the positive y-axis of the plane

The plane is defined using the right hand rule so the z- axis is the cross product of the x-axis and the y-axis, as illustrated below.

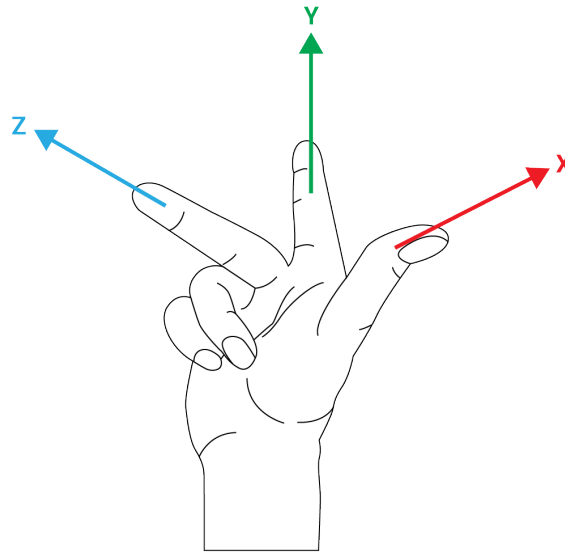

NOTICE

You can re-teach the plane in the opposite direction of the x-axis, if you want that plane to be normal in the opposite direction.

Modify an existing plane by selecting Plane and pressing Modify Plane. You will then use the same guide as for teaching a new plane.

**Example:
Manually
Updating a
Feature to Adjust
a Program**

Consider an application where multiple parts of a robot program is relative to a table. The figure below illustrates the movement through waypoints from wp1 to wp4.

```
Robot Program
MoveJ
  S1
MoveL # Feature: P1_var
  wp1
  wp2
  wp3
  wp4
```

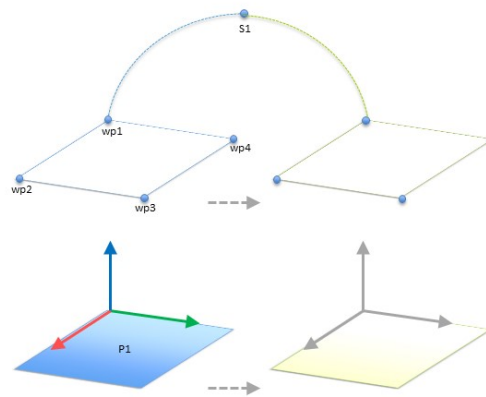

53.1: Simple program with four waypoints relative to a feature plane manually updated by changing the feature

53.2:

The application requires the program to be reused for multiple robot installations where the position of the table varies slightly. The movement relative to the table is identical. By defining the table position as a feature *P1* in the installation, the program with a *MoveL* command configured relative to the plane can be easily applied on additional robots by just updating the installation with the actual position of the table. The concept applies to a number of Features in an application to achieve a flexible program can solve the same task on many robots even though if other places in the work space varies between installations.

**Example:
Dynamically
Updating a
Feature Pose**

Consider a similar application where the robot must move in a specific pattern on top of a table to solve a particular task.

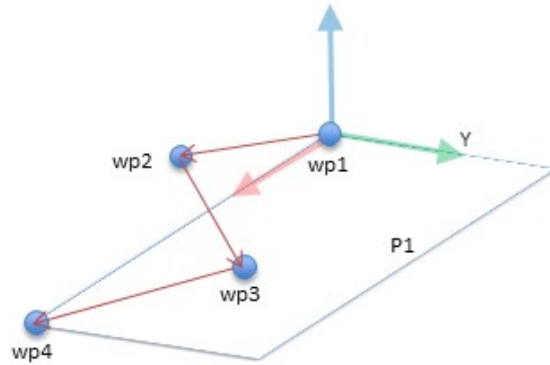

A *MoveL* command with four waypoints relative to a plane feature

Robot Program

```

MoveJ
  wp1
  y = 0.01
  o = p[0,y,0,0,0,0]
  P1_var = pose_trans(P1_var, o)
MoveL # Feature: P1_var
  wp1
  wp2
  wp3
  wp4
  
```

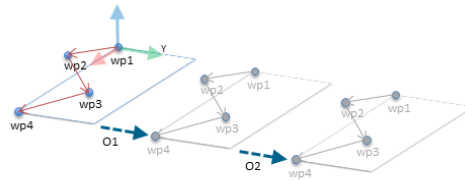

53.3: Applying an offset to the plane feature

53.4:

Robot Program

```

MoveJ
  S1
  if (digital_input[0]) then
    P1_var = P1
  else
    P1_var = P2
MoveL # Feature: P1_var
  wp1
  wp2
  wp3
  wp4
  
```

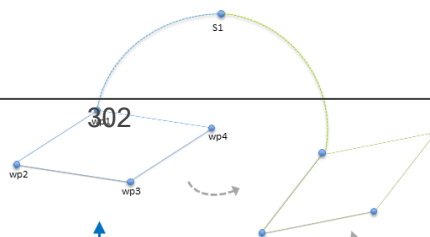

20.13.1. Feature Edit

Description

The Feature Edit is an alternative way to add features to your installation and/or edit existing features.

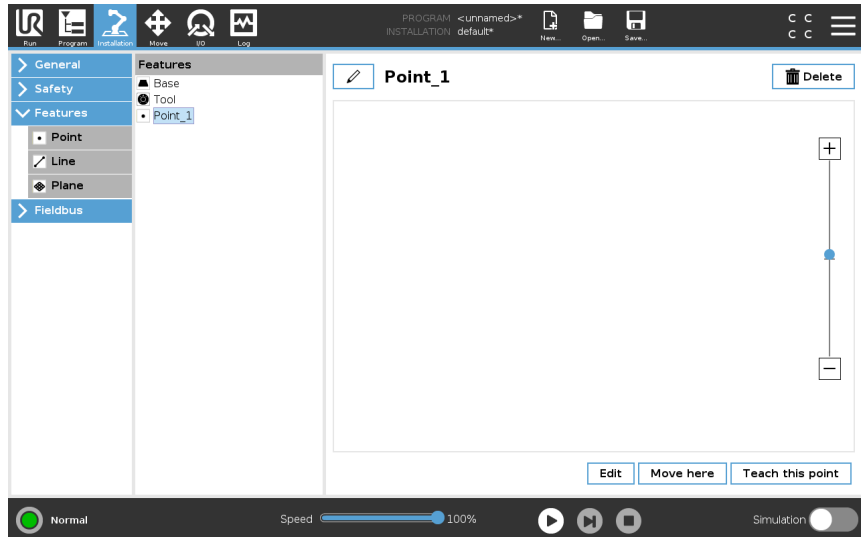

Use Edit to place and move features without moving the robot arm, so the feature can be placed outside of the robot arm's reach.

Editing a Point

You can edit a defined point or an undefined point. Editing an undefined point defines it.

1. In Installation, tap **Features**.
2. Under Features, select **Point** to add a point to your program tree.
3. Tap **Edit** to access the Edit screen to make changes to the position and rotation of the point

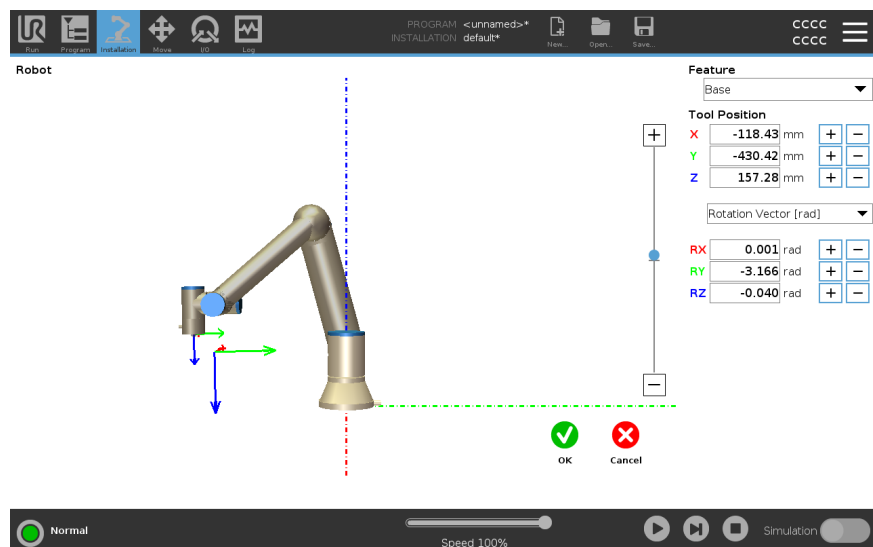

Editing a Line The line appears as two points in your program tree. You must define each point.

1. In Installation, tap **Features**.
2. Under Feature, select **Line** to add a line to your program tree.
3. The line is made up of two points:
 - Tap one point to edit those coordinates, then tap the other line point to edit those coordinates.

Editing a Plane

1. In Installation, tap **Features**.
2. Under Feature, select **Plane** to add a plane to your program tree.
3. Tap **Edit** to access the Edit screen to make changes to the position and rotation of the plane

20.14. Fieldbus

Description Here you can set the family of industrial computer network protocols used for real-time distributed control accepted by PolyScope: MODBUS, Ethernet/IP and PROFINET.

20.14.1. MODBUS Client I/O Setup

Description Here, the MODBUS client (master) signals can be set up. Connections to MODBUS servers (or slaves) on specified IP addresses can be created with input/output signals (registers or digital). Each signal has a unique name so it can be used in programs.



Refresh Push this button to refresh all MODBUS connections. Refreshing disconnects all modbus units, and connects them back again. All statistics are cleared.

Add unit Push this button to add a new MODBUS unit.

Delete unit	Push this button to delete the MODBUS unit and all signals on that unit.
Set unit IP	Here the IP address of the MODBUS unit is shown. Press the button to change it.
Sequential mode	<i>Available only when Show Advanced Options selected.</i> Selecting this checkbox forces the modbus client to wait for a response before sending the next request. This mode is required by some fieldbus units. Turning this option on may help when there are multiple signals, and increasing request frequency results in signal disconnects. The actual signal frequency may be lower than requested when multiple signals are defined in sequential mode. Actual signal frequency can be observed in signal statistics. The signal indicator turns yellow if the actual signal frequency is less than half of the value selected from the Frequency drop-down list.
Add signal	Push this button to add a signal to the corresponding MODBUS unit.
Delete signal	Push this button to delete a MODBUS signal from the corresponding MODBUS unit.
Set signal type	<p>Use this drop down menu to choose the signal type. Available types are:</p> <p><i>Digital input</i> A digital input (coil) is a one-bit quantity which is read from the MODBUS unit on the coil specified in the address field of the signal. Function code 0x02 (Read Discrete Inputs) is used.</p> <p><i>Digital output</i> A digital output (coil) is a one-bit quantity which can be set to either high or low. Before the value of this output has been set by the user, the value is read from the remote MODBUS unit. This means that function code 0x01 (Read Coils) is used. When the output has been set by a robot program or by pressing the set signal value button, the function code 0x05 (Write Single Coil) is used onwards.</p> <p><i>Register input</i> A register input is a 16-bit quantity read from the address specified in the address field. The function code 0x04 (Read Input Registers) is used.</p> <p><i>Register output</i> A register output is a 16-bit quantity which can be set by the user. Before the value of the register has been set, the value of it is read from the remote MODBUS unit. This means that function code 0x03 (Read Holding Registers) is used. When the output has been set by a robot program or by specifying a signal value in the set signal value field, function code 0x06 (Write Single Register) is used to set the value on the remote MODBUS unit.</p>



Set signal address This field shows the address on the remote MODBUS server. Use the on-screen keypad to choose a different address. Valid addresses depends on the manufacturer and configuration of the remote MODBUS unit.

Set signal name Using the on-screen keyboard, the user can give the signal a name. This name is used when the signal is used in programs.

Signal value Here, the current value of the signal is shown. For register signals, the value is expressed as an unsigned integer. For output signals, the desired signal value can be set using the button. Again, for a register output, the value to write to the unit must be supplied as an unsigned integer.

Signal connectivity status This icon shows whether the signal can be properly read/written (green), or if the unit responds unexpected or is not reachable (gray). If a MODBUS exception response is received, the response code is displayed. The MODBUS-TCP Exception responses are:

- E1* ILLEGAL FUNCTION (0x01) The function code received in the query is not an allowable action for the server (or slave).
 - E2* ILLEGAL DATA ADDRESS (0x02) The function code received in the query is not an allowable action for the server (or slave), check that the entered signal address corresponds to the setup of the remote MODBUS server.
 - E3* ILLEGAL DATA VALUE (0x03) A value contained in the query data field is not an allowable value for server (or slave), check that the entered signal value is valid for the specified address on the remote MODBUS server.
 - E4* SLAVE DEVICE FAILURE (0x04) An unrecoverable error occurred while the server (or slave) was attempting to perform the requested action.
 - E5* ACKNOWLEDGE (0x05) Specialized use in conjunction with programming commands sent to the remote MODBUS unit.
 - E6* SLAVE DEVICE BUSY (0x06) Specialized use in conjunction with programming commands sent to the remote MODBUS unit, the slave (server) is not able to respond now.
-

Show Advanced Options This check box shows/hides the advanced options for each signal.

**Advanced
Options**
Update Frequency

This menu can be used to change the update frequency of the signal. This means the frequency with which requests are sent to the remote MODBUS unit for either reading or writing the signal value. When the frequency is set to 0, then modbus requests are initiated on demand using a *modbus_get_signal_status*, *modbus_set_output_register*, and *modbus_set_output_signal* script functions.

Slave Address

This text field can be used to set a specific slave address for the requests corresponding to a specific signal. The value must be in the range 0-255 both included, and the default is 255. If you change this value, it is recommended to consult the manual of the remote MODBUS device to verify its functionality when changing slave address.

Reconnect count

Number of times TCP connection was closed, and connected again.

Connection status

TCP connection status.

Response time [ms]

Time between modbus request sent, and response received - this is updated only when communication is active.

Modbus packet errors

Number of received packets that contained errors (i.e. invalid length, missing data, TCP socket error).

Timeouts

Number of modbus requests that didn't get response.

Requests failed

Number of packets that could not be sent due to invalid socket status.

Actual freq.

The average frequency of client (master) signal status updates. This value is recalculated each time the signal receives a response from the server (or slave).

All counters count up to 65535, and then wrap back to 0.

20.14.2. EtherNet/IP

Description	<p>EtherNet/IP is a network protocol that enables the connection of the robot to an industrial EtherNet/IP Scanner Device.</p> <p>If the connection is enabled, you can select the action that occurs when a program loses EtherNet/IP Scanner Device connection.</p> <p>Those actions are:</p> <p><i>None</i></p> <p>PolyScope ignores the loss of EtherNet/IP connection and the program continues to run.</p> <p><i>Pause</i></p> <p>PolyScope pauses the current program. The program resumes from where it stopped.</p> <p><i>Stop</i></p> <p>PolyScope stops the current program.</p>
--------------------	---

20.14.3. PROFINET

Description	<p>The PROFINET network protocol enables or disables the connection of the robot to an industrial PROFINET IO-Controller.</p> <p>If the connection is enabled, you can select the action that occurs when a program loses PROFINET IO-Controller connection.</p> <p>Those actions are:</p> <p><i>None</i></p> <p>PolyScope ignores the loss of PROFINET connection and the program continues to run.</p> <p><i>Pause</i></p> <p>PolyScope pauses the current program. The program resumes from where it stopped.</p> <p><i>Stop</i></p> <p>PolyScope stops the current program.</p> <p>If the PROFINET engineering tool (e.g. TIA portal) emits a DCP Flash signal to the robot's PROFINET or PROFIsafe device, a popup in PolyScope is displayed.</p>
--------------------	--

20.14.4. PROFIsafe

Description

The PROFIsafe network protocol allows the robot to communicate with a safety PLC according to ISO 13849, Cat. 3 PLd requirements. The robot transmits safety state information to a safety PLC, then receives information to trigger safety related functions, such as: emergency stop or enter reduced mode.

The PROFIsafe interface provides a safe, network-based alternative to connecting wires to the safety IO pins of the robot control box.

PROFIsafe is only available on robots that have an enabling license, which you can obtain by contacting your local sales representative, once obtained, the license can be downloaded on [myUR](#).

Please refer to [Robot Registration and License file on page 338](#) for information regarding robot registration and license activation.

Communicating via PROFIsafe

A control message received from the safety PLC contains the information in the table below.

Signal	Description
E-Stop by system	Asserts the system e-stop.
Safeguard stop	Asserts the safeguard stop.
Reset safeguard stop	Resets safeguard stop state (on low-to-high transition in automatic mode) if the safeguard stop input is cleared beforehand.
Safeguard stop auto	Asserts safeguard stop if the robot is operating in Automatic mode. Safeguard stop auto shall only be used when a 3-Position Enabling (3PE) Device is configured. If no 3PE Device is configured, the safeguard stop auto acts as a normal safeguard stop input.
Reset safeguard stop auto	Resets safeguard stop auto state (on low-to-high transition when in automatic mode) if safeguard stop auto inputs are cleared beforehand.
Reduced mode	Activates the Reduced mode safety limits.
Operational mode	Activates either manual or automatic operational mode. If the safety configuration "Operational mode selection via PROFIsafe" is disabled, this field shall be omitted from the PROFIsafe control message.

Safety PLC message

A status message sent to the safety PLC contains the information in the table below.

Signal	Description
Stop, cat. 0	Robot is performing, or it has completed, a safety stop of category 0; A hard stop by immediate removal of power to the arm and the motors.

Stop, cat. 1	<p>Robot is performing, or it has completed, a safety stop of category 1; A controlled stop after which the motors are left in a power off state with brakes engaged.</p>
Stop, cat. 2	<p>Robot is performing, or it has completed, a safety stop of category 2; A controlled stop after which the motors are left in a power on state.</p>
Violation	<p>Robot is stopped because the safety system failed to comply with the safety limits currently defined.</p>
Fault	<p>Robot is stopped because of an unexpected exceptional error in the safety system.</p>
E-stop by system	<p>Robot is stopped because of one of the following conditions:</p> <ul style="list-style-type: none"> • a safety PLC connected via PROFIsafe has asserted system level e-stop. • an IMMI module connected to the control box has asserted a system level e-stop. • a unit connected to the system e-stop configurable safety input of the control box has asserted system level e-stop.
E-stop by robot	<p>The robot is stopped because of one of the following conditions:</p> <ul style="list-style-type: none"> • The e-stop button of the teach pendant is pressed. • An e-stop button connected to the robot e-stop non-configurable safety input of the control box is pressed.

Safeguard stop	<p>The robot is stopped due to one of the following conditions:</p> <ul style="list-style-type: none"> • A safety PLC connected via PROFIsafe has asserted the safeguard stop. • A unit connected to the safeguard stop non-configurable input of the control box has asserted the safeguard stop. • A unit connected to the safeguard stop configurable safety input of the control box has asserted the safeguard stop. <p>The signal follows the safeguard reset semantics. A configured safeguard stop reset functionality shall be used to reset this signal. PROFIsafe implies use of the safeguard reset functionality.</p> <p>The robot is stopped because it is operating in Automatic mode and because of one of the following conditions:</p> <ul style="list-style-type: none"> • A safety PLC connected via PROFIsafe has asserted safeguard stop auto. • A unit connected to a safeguard stop auto configurable safety input of the control box has asserted safeguard stop auto. <p>The signal follows the safeguard reset semantics. A configured safeguard stop reset functionality shall be used to reset this signal PROFIsafe implies use of the safeguard reset functionality</p> <p>Robot is stopped because it is operating in Manual mode and because of one of the following conditions:</p> <ul style="list-style-type: none"> • You are using a 3PE TP and none of the buttons are in the middle position. • A 3-position enabling device connected to a configurable safety input of the control box has asserted the 3PE stop. <p>Indication of the current operational mode of the robot. This mode can be: Disabled (0), Automatic (1), or Manual (2).</p>
Safeguard stop auto	
3PE stop	
Operational mode	

Reduced mode	Reduced mode safety limits are currently active.
Active limit set	The active set of safety limits. This can be: Normal (0), Reduced (1), or Recovery (2).
Robot moving	Robot is moving. If any joint moves at a velocity of 0.02 rad/s or higher the robot is considered in motion.
Safe home position	Robot is at rest (robot not moving), and in the position defined as the Safe Home Position.

Configuring PROFIsafe

Configuring PROFIsafe relates to programming the safety PLC, but requires minimal robot setup.

1. Connect the robot to a trusted network that accesses a safety compliant PLC.
2. On PolyScope, in the Header, tap **Installation**.
3. Tap Safety, select **PROFIsafe** and configure as needed.

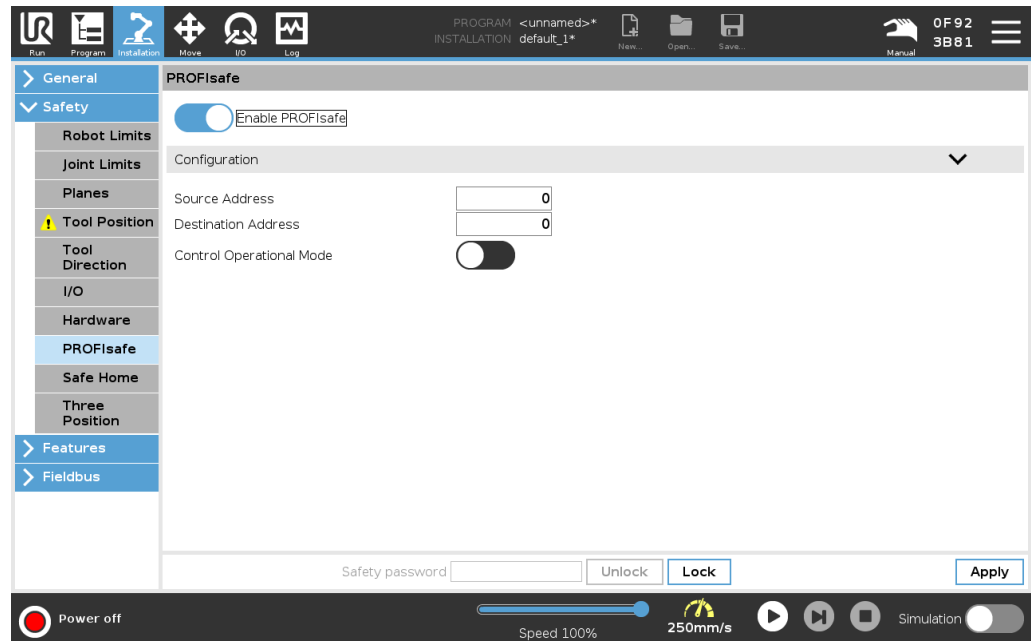

Enabling PROFIsafe

1. Enter the robot safety password and tap **Unlock**.
2. Use the switch button to enable PROFIsafe.
3. Enter a source address and destination address into the corresponding boxes.
These addresses are arbitrary numbers used by the robot and the safety PLC to identify each other.
4. You can switch the Control Operational Mode to the ON position if you want PROFIsafe to control the robot operational mode.
Only one source can control the operational mode of the robot. Therefore other sources of mode selection are disabled when operational mode selection via PROFIsafe is enabled.

The robot is now setup to communicate with a safety PLC.
You cannot release the robot's brakes if the PLC is not responding or if it is misconfigured.

21. Move Tab

Description

On this screen, you can move (jog) the robot arm directly, either by translating/rotating the robot tool, or by moving robot joints individually.

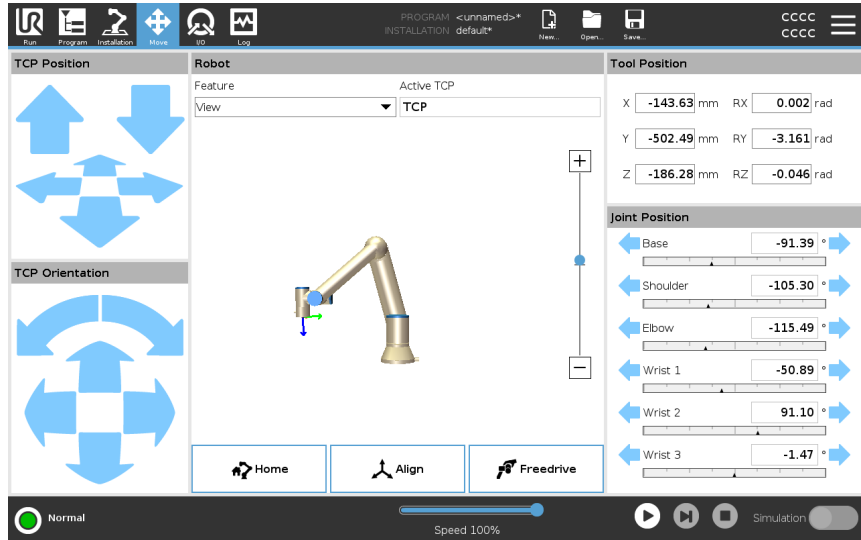

Move Tool

Hold down any of the **Move Tool** arrows to move the robot arm in a particular direction.

- The **Translate arrows** (upper) move the robot tool-tip in the direction indicated.
- The **Rotate arrows** (lower) change the orientation of the robot tool in the indicated direction. The rotation point is the Tool Center Point (TCP), i.e. the point at the end of the robot arm that gives a characteristic point on the robot's tool. The TCP is shown as a small blue ball.

Robot

If the current position of the robot TCP comes close to a safety or trigger plane, or the orientation of robot tool is near the tool orientation boundary limit (see [Safety Planes/Modes on page 150](#)), a 3D representation of the proximate boundary limit is shown. When the robot is running a program, the visualization of boundary limits is disabled.

Safety planes are visualized in yellow and black with a small arrow representing the plane normal, which indicates the side of the plane on which the robot TCP is allowed to be positioned. Trigger planes are displayed in blue and green and a small arrow pointing to the side of the plane, where the **Normal** mode limits (see [17.5 Software Safety Modes on page 139](#)) are active. The tool orientation boundary limit is visualized with a spherical cone together with a vector indicating the current orientation of the robot tool. The inside of the cone represents the allowed area for the tool orientation (vector).

When the robot TCP is no longer in proximity of the limit, the 3D representation disappears. If the TCP is in violation or very close to violating a boundary limit, the visualization of the limit turns red.

Feature	Under Feature , you can define how to control the robot arm relative to View , Base or Tool features. For the best feel for controlling the robot arm you can select the View feature, then use Rotate arrows to change the viewing angle of the 3D image to match your view of the real robot arm.
Active TCP	In the Robot field, under Active TCP , the name of the current active Tool Center Point (TCP) is displayed.
Home	The Home button accesses the Move Robot into Position screen, where you can hold down the Auto button (see Move robot to on page 169) to move robot into position previously defined under Installation (see Defining Home on page 291). The Home button's default setting returns the Robo Arm to an upright position (see 20.9 Home on page 290).
Freedrive	The on-screen Freedrive button allows the Robot Arm to be pulled into desired positions/poses.
Align	The Align button allows the Z axis of the active TCP to align to a selected feature.
Tool Position	The text boxes display the full coordinate values of the TCP relative to the selected feature. You can configure several named TCPs (see). You can also tap Edit pose to access the Pose Editor screen.
Joint Position	The Joint Position field allows you to directly control individual joints. Each joint moves along a default joint limit range from -360° to $+360^{\circ}$, defined by a horizontal bar. Once the limit is reached you cannot move a joint any further. You can configure joints with a position range different from the default (see 17.6.2 Joint Limits on page 142), this new range is indicated with red zone inside the horizontal bar.

Example

WARNING

1. In the **Setup** tab, if the gravity setting (see) is wrong, or the robot arm carries a heavy load, the robot arm can start moving (falling) when you press the **Freedrive** tab. In that case, release **Freedrive** again.
2. Use the correct installation settings (e.g. Robot mounting angle, payload mass and payload center of gravity offset). Save and load the installation files along with the program.
3. Payload settings and robot mounting settings must be set correctly before operating the **Freedrive** button. If these settings are not correct, the robot arm will move when you activate **Freedrive**.
4. The **Freedrive** function must only be used in installations where the risk assessment allows it. Tools and obstacles must not have sharp edges or pinch points. Make sure that all personnel remain outside the reach of the robot arm.

21.1. Pose Editor Screen

Description Once you access the **Pose Editor** screen, you can precisely configure a target joint positions, or a target pose (position and orientation) for the TCP. Note: This screen is **offline** and does not control the Robot Arm directly.

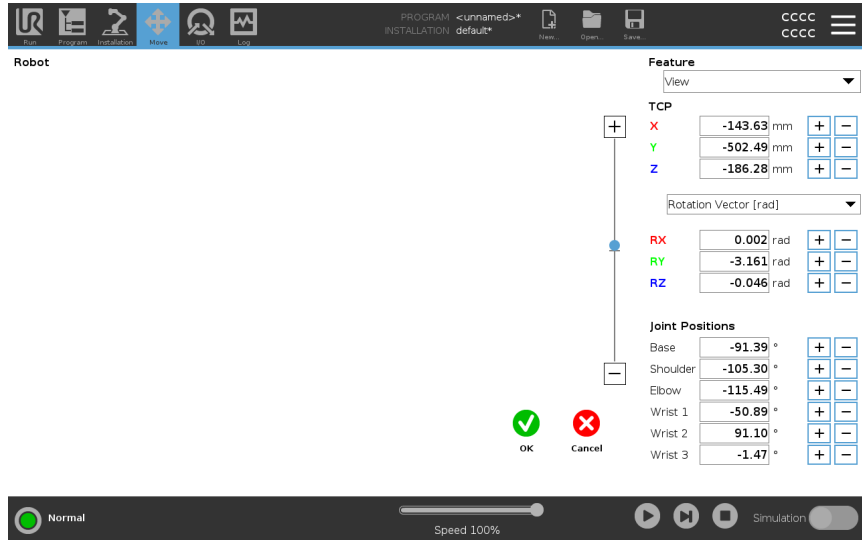

Robot The 3D image shows the current Robot Arm position. The **shadow** shows the Robot Arm target position controlled by the specified values on the screen. Press the magnifying glass icons to zoom in/out or drag a finger across it to change the view. If the specified target position of the robot TCP is close to a safety or trigger plane, or the orientation of robot tool is near the tool orientation boundary limit (see [Safety Planes Modes on page 150](#)), a 3D representation of the proximate boundary limit is shown. Safety planes are visualized in yellow and black with a small arrow representing the plane normal, which indicates the side of the plane on which the robot TCP is allowed to be positioned. Trigger planes are displayed in blue and green and a small arrow pointing to the side of the plane, where the **Normal** mode limits (see [17.5 Software Safety Modes on page 139](#)) are active. The tool orientation boundary limit is visualized with a spherical cone together with a vector indicating the current orientation of the robot tool. The inside of the cone represents the allowed area for the tool orientation (vector). When the target robot TCP is no longer in proximity of the limit, the 3D representation disappears. If the target TCP is in violation or very close to violating a boundary limit, the visualization of the limit turns red.

Feature and Tool Position The active TCP and coordinate values of the selected feature are displayed. The **X, Y, Z** coordinates specify tool position. The **RX, RY, RZ** coordinates specify orientation. For further information about configuring several named TCPs, see [20.1 TCP Configuration on page 274](#) .

Use the drop down menu above the **RX, RY** and **RZ** boxes to choose the orientation representation type:

- **Rotation Vector [rad]** The orientation is given as a *rotation vector*. The length of the axis is the angle to be rotated in radians, and the vector itself gives the axis about which to rotate. This is the default setting.
- **Rotation Vector [°]** The orientation is given as a *rotation vector*, where the length of the vector is the angle to be rotated in degrees.
- **RPY [rad]** *Roll, pitch and yaw (RPY)* angles, where the angles are in radians. The RPY-rotation matrix (X, Y, Z" rotation) is given by:

$$R_{rpy}(\gamma, \beta, \alpha) = RZ(\alpha) \cdot RY(\beta) \cdot RX(\gamma)$$
- **RPY [°]** *Roll, pitch and yaw (RPY)* angles, where angles are in degrees.

You can tap the values to edit the coordinates. You can also tap the **+** or **-** buttons to the right of a box to add/subtract an amount to/from the current value. Or you can hold down a button to directly increase/decrease the value.

Joint Positions Individual joint positions are specified directly. Each joint position can have Joint Limit range from -360° to $+360^\circ$. You can configure Joint Positions as follows:

- Tap the joint position to edit the values.
- Tap the **+** or **-** buttons to the right of a box to add or subtract an amount to/from the current value.
- Hold down a button to directly increase/decrease the value.

OK Button If you activate this screen from the **Move** screen (see), tap the **OK** button to return to the **Move** screen. The Robot Arm moves to the specified target. If the last specified value was a tool coordinate, the Robot Arm moves to the target position using movement type **MoveL**; or it uses movement type **MoveJ** if a joint position was specified last.

Cancel Button The **Cancel** button exits the screen discarding all changes.

22. I/O Tab

Description

On this screen you can always monitor and set the live I/O signals from/to the robot control box.

The screen displays the current state of the I/O, including during program execution. If anything is changed during program execution, the program will stop.

At program stop, all output signals will retain their states. The screen is updated at only 10Hz, so a very fast signal might not display properly.

Configurable I/Os can be reserved for special safety settings defined in the safety I/O configuration section of the installation (see [17.7 Safety I/O on page 145](#)); those which are reserved will have the name of the safety function in place of the default or user defined name.

Configurable outputs that are reserved for safety settings are not togglable and will be displayed as LED's only.

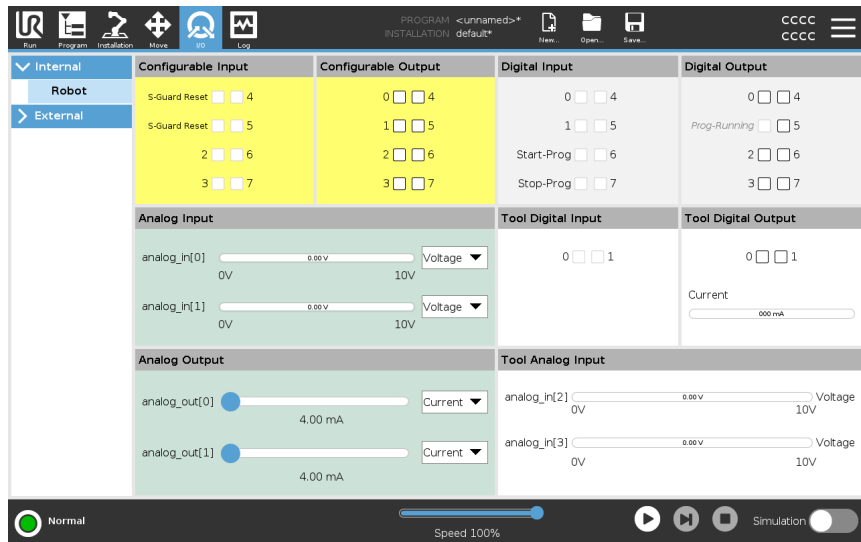

Voltage

In Tool Output, Voltage can be configured only when Tool Output is controlled by the User. Selecting a URCap removes access to the Voltage.

Analog Domain Settings

The analog I/O's can be set to either current [4-20mA] or voltage [0-10V] output. The settings will be remembered for eventual later restarts of the robot controller when a program is saved. Selecting a URCap, in Tool Output, removes access to the Domain Settings for the analog Tool Inputs.

**Tool
Communication
Interface**

When the **Tool Communication Interface TCI** is enabled, the tool analog input becomes unavailable. On the **I/O** screen, the **Tool Input** field changes as illustrated below.

Tool Analog Input	
Baud Rate	115200
Parity	None
Stop Bits	One
RX Idle Chars	1.50
TX Idle Chars	3.50

NOTICE

When the **Dual Pin Power** is enabled, the tool digital outputs must be named as follows:

- tool_out[0] (Power)
- tool_out[1] (GND)

The **Tool Output** field is illustrated below.

Tool Digital Output	
Power	<input type="checkbox"/> <input type="checkbox"/> GND
Current	<input type="text" value="000 mA"/>

22.1. MODBUS

Description The screenshot below displays the MODBUS client I/O signals as they are set up in the installation. Using the drop-down menus at the top of the screen, you can change the displayed content based on signal type and MODBUS unit if more than one is configured.

Each signal in the lists contains its connections status, value, name, and signal address.

The output signals can be toggled if the connection status and the choice for I/O tab control allows it. See [22 I/O Tab](#) on page 320

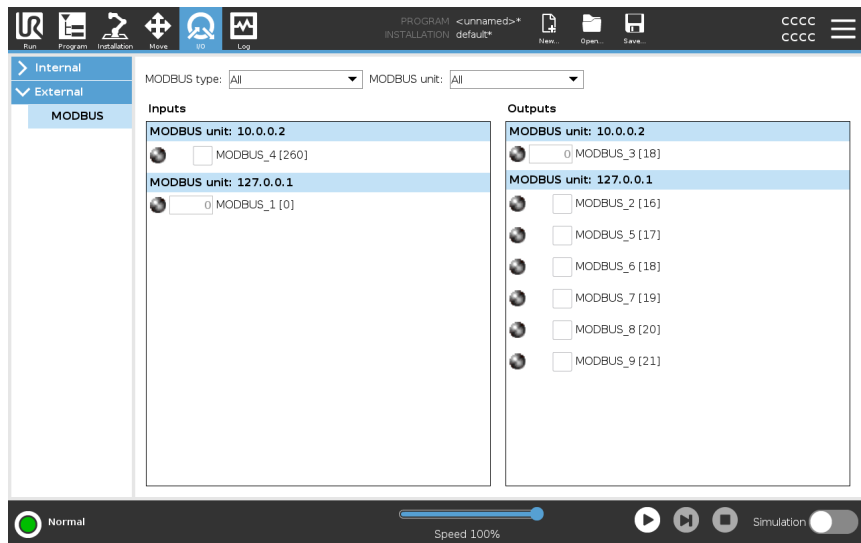

23. Log Tab

Description

The **Log** tab displays information about the robot arm and Control Box.

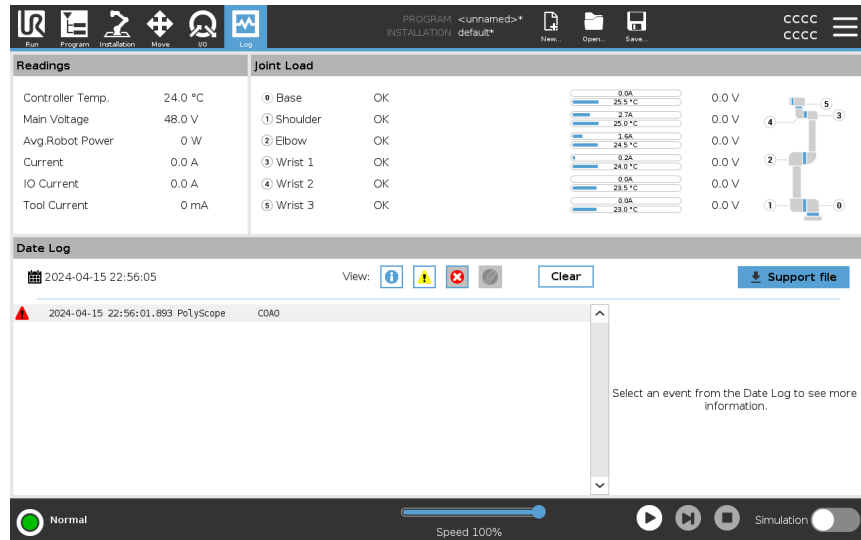

Readings and Joint Load

The Readings pane displays Control Box information. The Joint Load pane displays information for each robot arm joint. Each joint displays:

- Temperature
- Load
- Status
- Voltage





Date Log

The first column displays log entries, categorized by the severity. The second column shows a paperclip if there is an Error Report associated with the log entry. The next two columns display the messages' time of arrival and the source of the message. The last column shows a short description of the message itself.

Some log messages are designed to provide more information that is displayed on the right side, after selecting the log entry.

Message Severity

You can filter messages by selecting the toggle buttons that correspond to the severity of the log entry or by whether an attachment is present. The following table describes message severity.

	Provides general information, such as status of a program, changes of the controller and controller version.
	Issues that may have occurred but the system was able to recover.
	A violation occurs if the safety limit is exceeded. This causes the robot to perform a safety rated stop.
	A fault occurs if there is an unrecoverable error in the system. This causes the robot to perform a safety rated stop.

When you select a log entry, additional information appears on the right side of the screen. Selecting the attachments filter either displays entry attachments exclusively or, displays all entries.

Saving Error Reports

A detailed status report is available when a paper clip icon appears on the log line.



NOTICE

The oldest report is deleted when a new one is generated. Only the five most recent reports are stored.

1. Select a log line and tap the Save Report button to save the report to a USB drive.

You can save the report while a program is running.

You can track and export the following list of errors:

- Emergency stop
- Fault
- Internal PolyScope exceptions
- ¹Robot Stop
- Unhandled exception in URCap
- Violation

The exported report contains: a user program, a history log, an installation and a list of running services.

¹Robot stop was previously known as "Protective Stop" for Universal Robots robots.

**Technical
Support File**

The report file contains information that is helpful to diagnose and reproduce issues. The file contains records of previous robot failures, as well as current robot configurations, programs and installations. The report file can be saved to external USB drive. On the Log screen, tap **Support file** and follow the on-screen instructions to access the function.

**NOTICE**

The export process can take up to 10 minutes depending on USB drive speed and the size of files collected from robot file system. The report is saved as a regular zip file, that is not password protected, and can be edited before sending to technical support.

24. Program and Installation Manager

Description

The Program and Installation Manager refers to three icons that allow you to create, load and configure Programs and Installations:

- **New...**
- **Open...**
- **Save...**

The File Path displays your current loaded Program name and the type of Installation. File Path changes when you create or load a new Program or Installation. You can have several installation files for a robot. Programs created load and use the active installation automatically.



Open...

Allows you to load a Program and/or Installation.

Opening a Program

1. In the Program and Installation Manager, tap **Open...** and select Program.
2. On the Load Program screen, select an existing program and tap Open.
3. In the File Path, verify that the desired program name is displayed.

Opening an Installation.

1. In the Program and Installation Manager, tap **Open...** and select Installation.
2. On the Load Robot Installation screen, select an existing installation and tap Open.
3. In the Safety Configuration box, select Apply and restart to prompt robot reboot.
4. Select Set Installation to set installation for the current Program.
5. In the File Path, verify that the desired installation name is displayed.

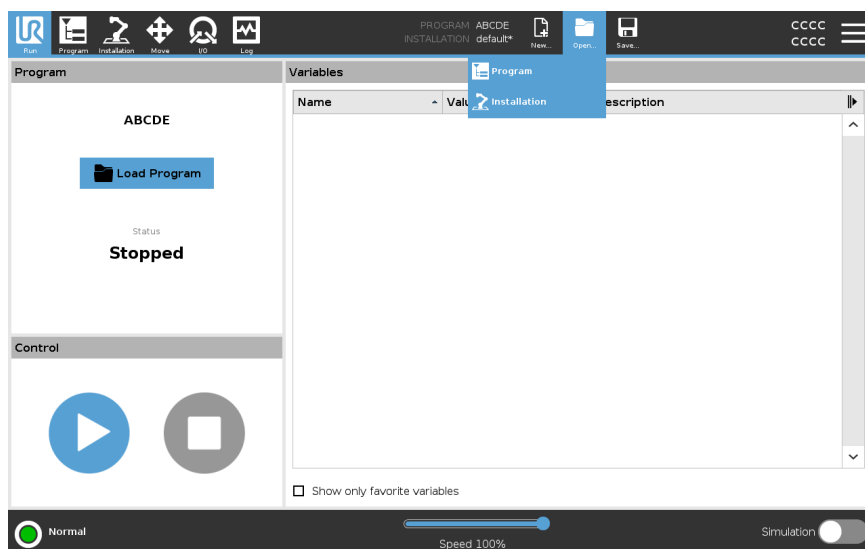

New...

Allows you to create a new Program and/or Installation.

Creating a new Program

1. In the Program and Installation Manager, tap **New...** and select Program.
2. On the Program screen, configure your new program as desired.
3. In the Program and Installation Manager, tap **Save...** and select Save All or Save Program As...
4. On the Save Program As screen, assign a file name and tap Save.
5. In the File Path, verify that the new program name is displayed.

Creating a new Installation

Save your installation for use after powering down the robot.

1. In the Program and Installation Manager, tap **New...** and select Installation.
2. Tap Confirm Safety Configuration.
3. On the Installation screen, configure your new installation as desired.
4. In the Program and Installation Manager, tap **Save...** and select Save Installation As...
5. On the Save Robot Installation screen, assign a file name and tap Save.
6. Select Set Installation to set installation for the current Program.
7. In File Path, verify that the new installation name is displayed.

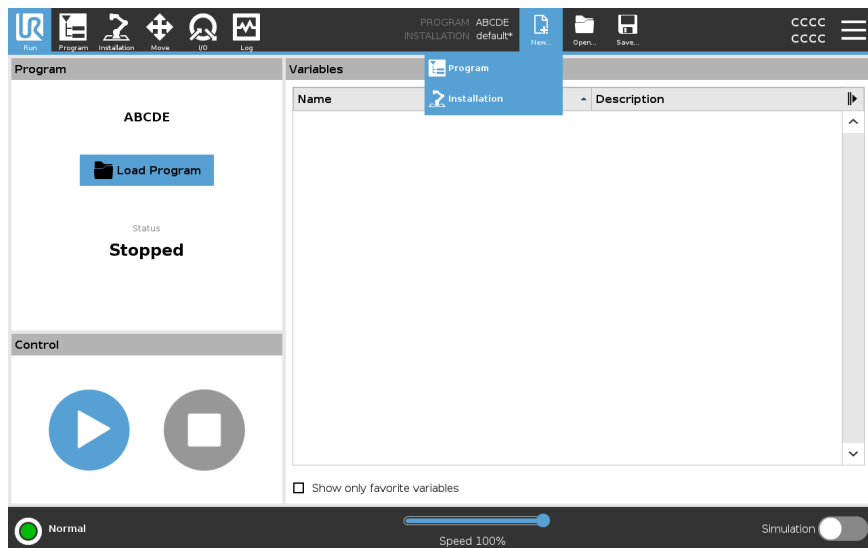

Save...

Save... proposes three options. Depending on the program/installation you load-create, you can:

- **Save All** to save the current Program and Installation immediately, without the system prompting to save to a different location or different name. If no changes are made to the Program or Installation, the Save All... button appears deactivated.
- **Save Program As...** to change the new Program name and location. The current Installation is also saved, with the existing name and location.
- **Save Installation As...** to change the new Installation name and location. The current Program is saved, with the existing name and location.

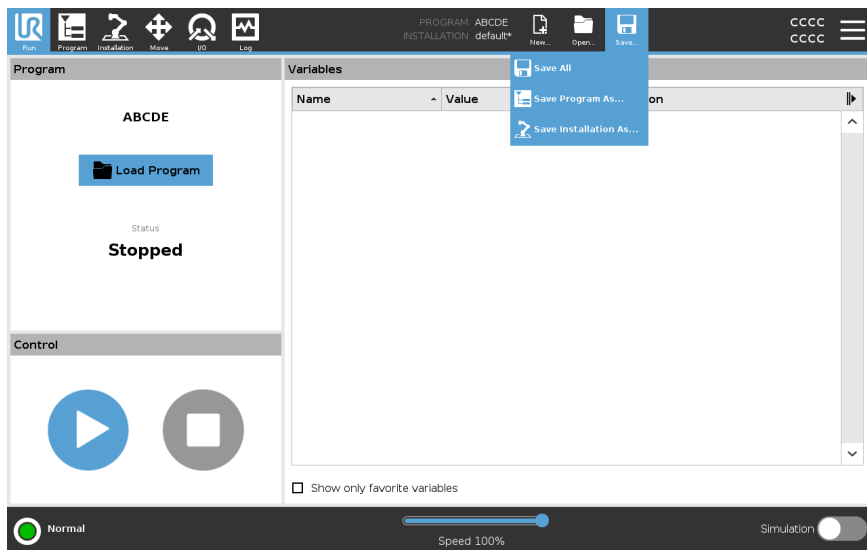

24.1. File Manager

Description

This image shows the load screen which consists of the following buttons:

- **Breadcrumb Path**
The breadcrumb path shows a list of directories leading to the present location. By selecting a directory name in the breadcrumb, the location changes to that directory and displays it in the file selection area.
- **File Selection Area**
Tap the name of a file to open it. Directories are selected by pressing their name for half a second.
- **File Filter**
You can specify the file types shown. After selecting Backup Files, this area displays the 10 most recently saved program versions, where '.old0' is the newest and '.old9' is the oldest.
- **Filename**
The selected file is shown here. When saving a file, use the text field to manually enter the file name.
- **Action buttons**
The action bar consists of a series of buttons that enable you to manage files.

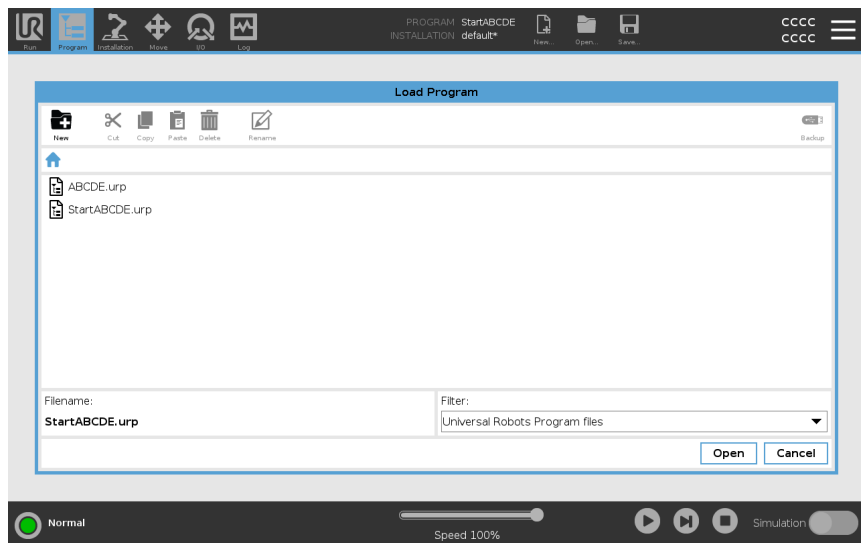

The 'Backup' action to the right of the action bar supports backing up the currently selected files and directories to the location and to a USB. The 'Backup' action is only enabled when an external media is attached to the USB port.

25. Hamburger menu

Description The hamburger menu contains the general settings for PolyScope among these password, system and security settings.

25.1. About

Description Use the About option to access and display different types of data about the robot. You can display the robot's General data, Version and Legal data.

To display data about the robot

1. In the Header, tap the **Hamburger** menu.
2. Select **About**.
3. Tap **General** to access the robot's software version, network settings and serial number.

For the other data types you can:

- Tap **Version** to display more detailed data about the robot's software version.
 - Tap **Legal** to display data about the robot's software license/s.
4. Tap **Close** to return to your screen.
-

25.1.1. Help

Description

You can access the online help description for PolyScope, the robot arm, control box and other documents that might be helpful. You can access the help via a QR code, or type the following URL in a browser: help.universal-robots.com.

You can find the following pieces of documentation:

- Robot arm hardware description
 - Control box hardware description
 - PolyScope software manual
 - Service manual
 - Script manual
 - Error codes reference
-

To find the QR code and URL

1. In the top right corner of PolyScope, tap the Hamburger button .



2. In the dropdown menu, tap .
3. Now you can scan the QR code to access help.universal-robots.com.

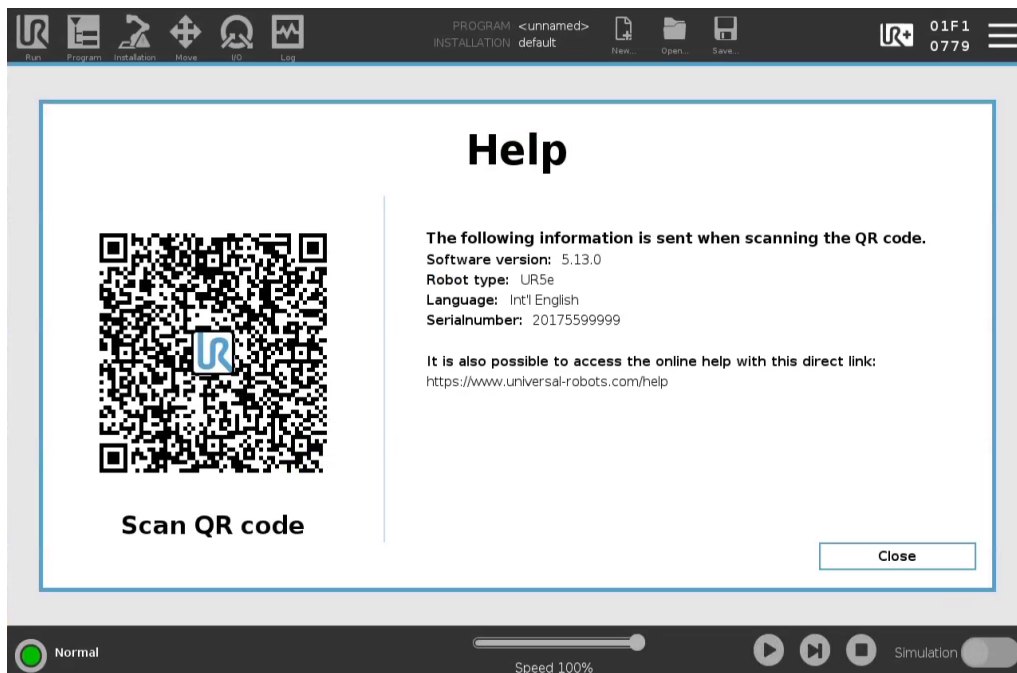

NOTICE

When you scan the QR code the following information will be sent with the QR code, and can be used in customer analytics at Universal Robots:

- PolyScope software version installed
- Robot type and size
- Language in Polyscope
- Serial number of the robot arm

25.2. Settings

To personalize PolyScope settings

1. In the Header, tap the Hamburger menu and select **Settings**.
 2. In the Side Menu on the left, select an item to personalize. If an operational mode password was set, in the Side Menu, **System** is only available to the programmer.
 3. On the bottom right, tap **Apply and Restart** to implement your changes.
 4. On the bottom left, tap **Exit** to close Settings screen without changes.
-

25.2.1. Preferences

Description

Preferences contain the most basic settings, and would probably only be set once at first start up.

Languages

Description

You can change the PolyScope language and measurement unit (Metric or Imperial).

Run Screen

Description

Located at the base of the Run tab screen, the Speed Slider allows the operator to change the speed of a running Program.

To hide the Speed Slider

1. In the Header, tap the Hamburger menu icon and select **Settings**.
 2. Under Preferences, tap **Run Screen**.
 3. Select check box to show or hide **Speed Slider**.
-

Time

Description You can access and/or adjust the current time and date displayed on the PolyScope.

- Time**
1. In the Header, tap the Hamburger menu icon and select **Settings**.
 2. Under Preferences, select **Time**.
 3. Verify and/or adjust **Time** and/or **Date** as desired.
 4. Tap **Apply and Restart** to apply your changes.

Date and Time are displayed in the Log tab (see [Date Log on page 323](#)) under **Date Log**.

25.2.2. Password

Description Password contain the management of passwords and administrator's password.

Password Settings

Setting a Password You must set a password to Unlock all safety settings that make up your Safety Configuration. If no safety password is applied, you are prompted to set it up.

- To set a Password**
1. In your PolyScope header right corner, press the **Hamburger** menu and select **Settings**.
 2. On the left of the screen, in the blue menu, press **Password** and select **Safety**.
 3. In **New password**, type a password.
 4. Now, in **Confirm new password**, type the same password and press **Apply**.
 5. In the bottom left of the blue menu, press **Exit** to return to previous screen.

You can press the **Lock** tab to lock all Safety settings again or simply navigate to a screen outside of the Safety menu.

Safety password

Administrator Password

Description Use the Admin Password to change the security configuration of the system, including network access. The Admin password is equal to the password used for the root user account on the Linux system running on the robot, which may be needed in some network use cases such as SSH or SFTP.



WARNING

You cannot recover a lost Admin password.

- Take the appropriate steps to ensure your admin password is not lost.

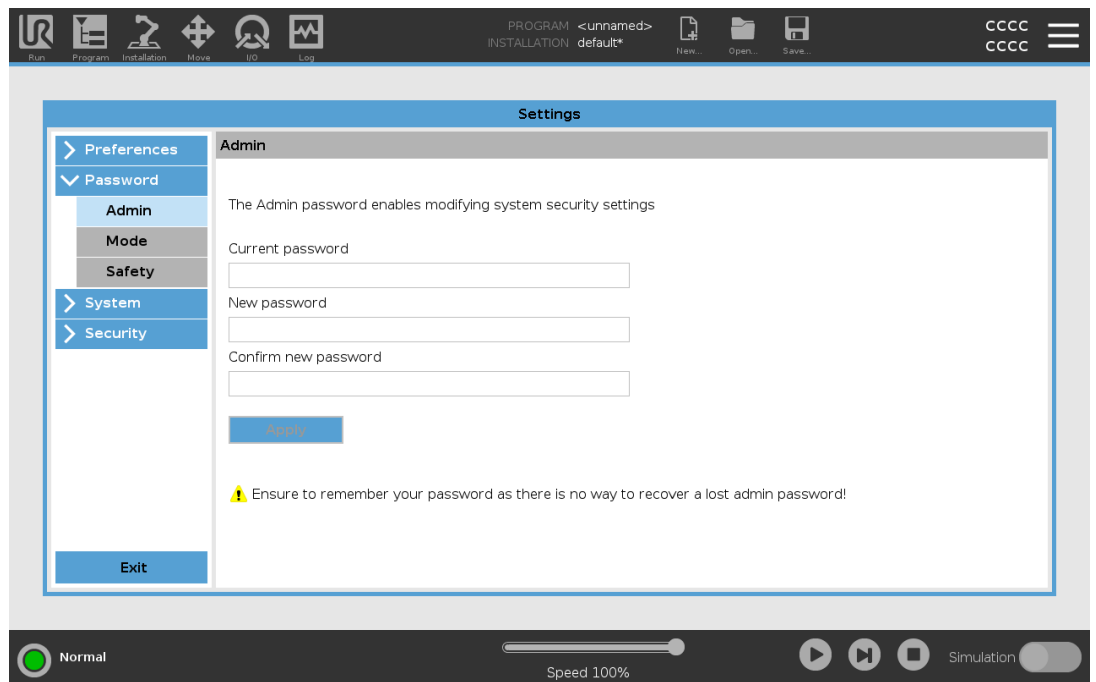

To set the Admin Password

1. In the Header, tap the Hamburger menu icon and select **Settings**.
2. Under **Password**, tap **Admin**.
3. Under **Current password**, put in the default password: **easybot**.
4. Under **New password**, create a new password.
Creating a strong, secret password obtains the best security for your system.
5. Under **Confirm new password**, repeat your new password.
6. Tap **Apply** to confirm your password change.

Safety

The Safety password prevents unauthorized modification of the Safety settings.

Operational Mode Password

Description The Operational Mode Password, or mode password, creates two different user roles on PolyScope:

- Manual
- Automatic

When the mode password is set, programs and installations can only be created and edited in Manual mode. Automatic mode only allows the operator to load pre-made programs (see [16.9 Operational Mode Selection on page 130](#) for more information on the modes). Once a password has been set, a new Mode icon appears in the Header.

Switching operational modes, from Manual to Automatic and from Automatic to Manual, causes PolyScope to prompt for the new password.

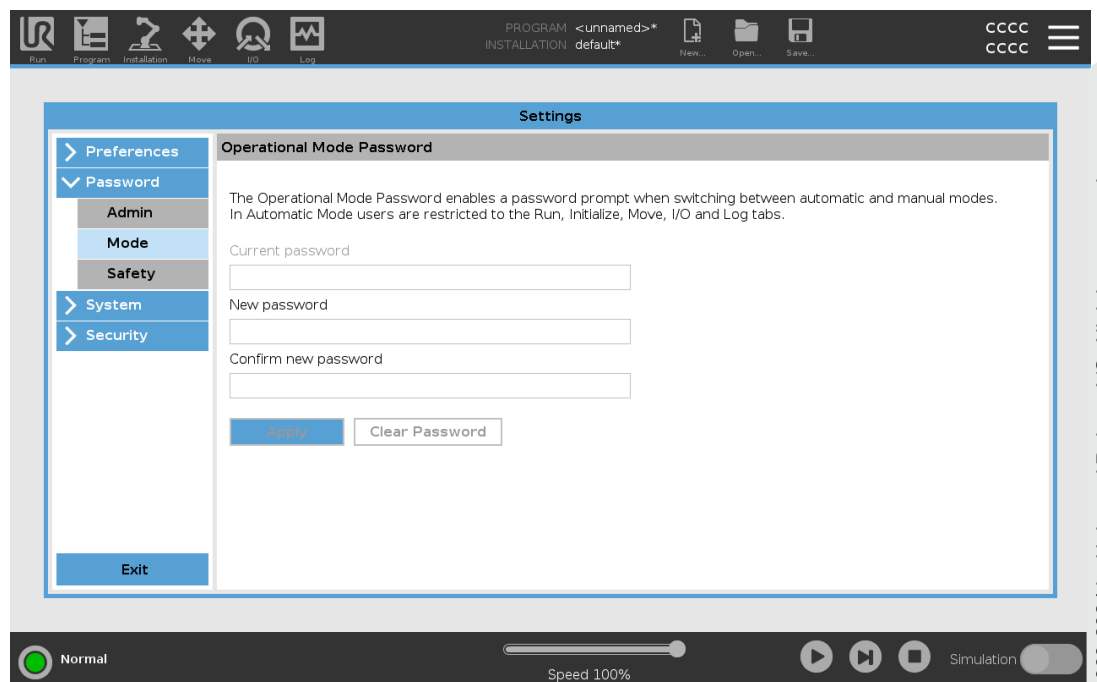

Copyright © 2009-2024 by Universal Robots A/S. All rights reserved.

To set the Mode Password

1. In the Header, tap the Hamburger menu icon and select **Settings**.
2. Under **Password**, tap **Mode**.
3. Under **New password**, create a new password.
Creating a strong, secret password obtains the best security for your system.
4. Under **Confirm new password**, repeat your new password.
5. Tap **Apply** to confirm your password change.

25.2.3. System

Description The system settings control backup of the system, URcaps and networks settings among other.

System Backup

Description



NOTICE

Use one of the USB ports inside the Control Box (CB) when doing a Backup and Restore operation. Using a CB USB port is more stable and running a Backup requires less time.



NOTICE

If you restore a system with a new SD card, you must match the Serial Number in the new SD card image when you start up Polyscope. Failure to match the Serial Number can result in an incomplete restore process. A restore error appears for not finding the matching serial number

Backup and Restore

Save a full copy of your system to a USB drive and use it to restore your system back to a previous state. This may be necessary after disk corruption or accidental deletion.

To backup the system

1. In the Header, tap the Hamburger menu icon and select **Settings**.
2. Under System, tap **Backup Restore**.
3. Select Location to store the back-up and press **Backup**.
4. Tap **OK** for full system reboot.

To restore the system

1. In the Header, tap the Hamburger menu icon and select **Settings**.
2. Under System, tap **Backup Restore**.
3. Select your Backup file and press **Restore**.
4. Tap **OK** to confirm.

Robot Registration and License file

Description

It is necessary to register the robot and download and install the License File, because the license file will include all available software licenses.

Activate Remote TCP & Toolpath URCap via web

It is possible to activate the Remote TCP & Toolpath URCap directly from www.universal-robots.com/activate.

This is only possible for Remote TCP & Toolpath URCap. If you plan to obtain additional licenses via myUR, please activate Remote TCP & Toolpath URCap first.

Activate the Software Licenses via myUR



NOTICE

If you have more than one active license, all licenses will be included in the downloaded license file.

If you have not registered your robot, please go to the URL on the screen at step 1 and register your robot.

1. Download the license file to your PC.
2. Copy the license file to the USB and connect it to the Teach Pendant.
3. On the Settings screen, in Step 3, tap **Load file** to open the **Select license file** screen.
4. In the list, select the USB to display content and navigate to the license file.
5. Select **license.p7b** and tap **Open** to confirm robot registration.
6. On the bottom left, tap **Exit**.

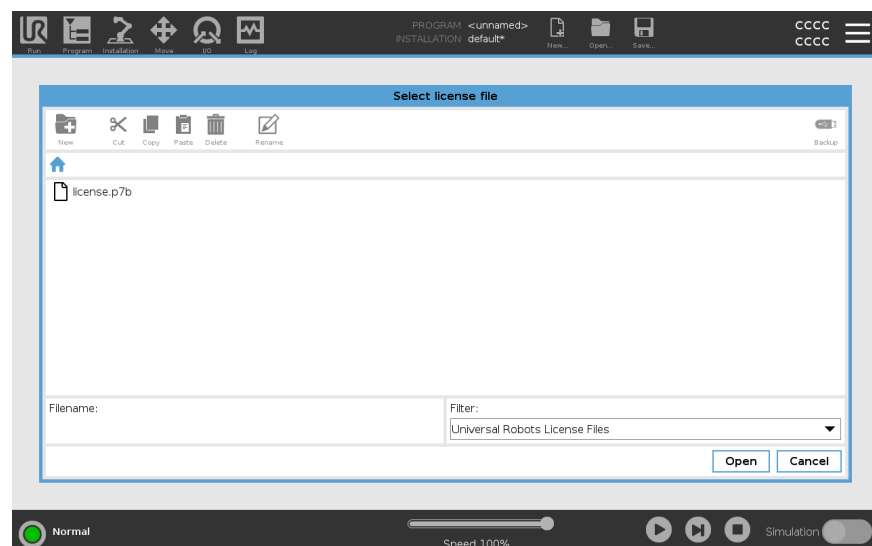
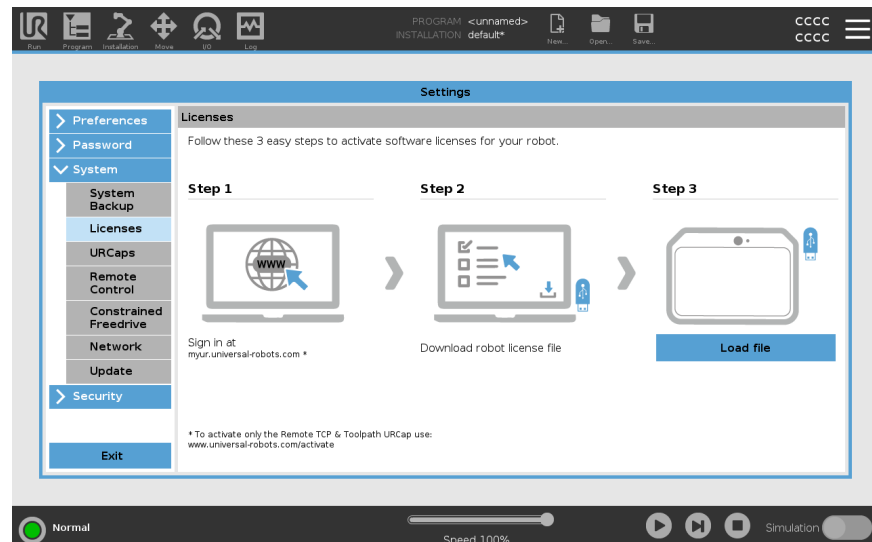



Deactivate Software Licenses

- A new license file is required if the robot changes owners. In this case, the license file must be deactivated.
- If you purchase a new software license for your robot, it is necessary to deactivate and reactivate the license file in order to add the new software license.

1. In the Header, tap the **Hamburger Menu** and select **Settings**.
2. In the menu on the left, tap **System** and select **Licenses**.
3. On the bottom right of the Settings screen, tap **Deactivate**.
4. Please see [Activate the Software Licenses via myUR on the previous page](#)

URCaps

Description

Managing URCaps
You can manage your existing **URCaps** or install a new one in your robot.

To manage URCaps

1. In the Header, press the Hamburger menu and select **Settings**.
2. Under System, select **URCaps**.
3. Tap the **+** button, select the **.urcap** file and press **Open**.
4. If you wish to proceed with the installation of that URCap, press **Restart**. After that step, the URCaps is installed and ready to be used.
5. To remove an installed URCaps, select it from Active URCaps, press the **-** button and press **Restart** so changes can take effect.

Active URCaps

Details about the new URCap appear in the **Active URCaps** field.
A status icon indicates the state of the URCap, as listed below:

- URCap ok: The URCap is installed and running normally.
- URCap fault: The URCap is installed but unable to start. Contact the URCap developer.
- URCap restart needed: The URCap has just been installed and a restart is required.

Example

Error messages and information about the URCap appear in the **URCaps Information** field. Different error messages appear depending on the type of error/s detected.

Remote Control

Description

A robot can either be in Local Control (controlled from the Teach Pendant) or Remote Control (controlled externally).

Remote Control allows you to control the robots via external sources, such as controller sockets, I/Os and the Dashboard Server.

This can be used to send simple commands to PolyScope such as: Starting or loading programs as well as sending UR Script commands directly to the controller.

CAUTION

To ensure safe usage, the robot can either be in "Remote Control" mode or "Local Control" mode.

"Local Control" mode will ensure that any commands, sent to the controller from an external source, will be rejected while the robot is controlled in person.

To enable Remote Control

1. In the Header, tap the Hamburger menu and select **Settings**.
2. Under System, select **Remote Control**.
3. Tap **Enable** to make the Remote Control feature available. PolyScope remains active. Enabling Remote Control does not immediately start the feature. It allows you to switch from Local Control to Remote Control.
4. In the profile menu, select **Remote Control** to alter PolyScope. You can return to Local Control by switching back in the profile menu.

NOTICE

- Although Remote Control limits your actions in PolyScope, you can still monitor robot state.
- When a robot system is powered off in Remote Control, it starts up in Remote Control.

Settings Requirements

Control of the robot via network or digital input is, by default, restricted.

- Enable and select the Remote Control feature removes this restriction.
- Enable Remote Control by switching to the Local Control profile (PolyScope control) of the robot, allowing all control of running programs and executing scripts to be performed remotely.
- Enable the Remote Control feature in Settings to access Remote mode and Local mode in the profile.



**Local Control
does not allow**



- Power on and brake release sent to the robot over network
 - Receiving and executing robot programs and installation sent to the robot over network
 - Autostart of programs at boot, controlled from digital inputs
 - Auto brake release at boot, controlled from digital inputs
 - Start of programs, controlled from digital inputs
-

**Remote Control
does not allow**



- Moving the robot from Move Tab
 - Starting from Teach Pendant
 - Load programs and installations from the Teach Pendant
 - Freedrive
-

Network

Description

You can configure robot connection to a network by selecting one of three available network methods:

- DHCP
- Static Address
- Disabled network (if you don't wish to connect your robot to a network)

Depending on the network method you select, configure your network settings:

- IP Address
- Subnet Mask
- Default Gateway
- Preferred DNS Server
- Alternative DNS Server

Update

Description

Install updates from a USB to ensure the robot software is up-to-date.

To update software

1. In the Header, tap the Hamburger menu icon and select **Settings**.
2. Under System, tap **Update**.
3. Insert an USB and tap **Search** to list valid update files.
4. In the list of valid update files, select desired version and tap **Update** to install.



WARNING

Always check your program/s after a software upgrade. The upgrade might change the trajectories in your program.

25.2.4. Security

Description

The default admin password for a Universal Robots robot arm controller is “easybot”. It is a factory setting, configured on all new robots.



WARNING

It is critically important that you change this default admin password to your own password, to ensure cyber security of your robot.

As of PolyScope update 5.14 all security settings are set by default to restrictive (disabled or blocked). (This only applies to new robots and newly created SD-cards. Otherwise, refer to a guide “[Secure setup of UR cobots](#)”).
If any of the settings are needed to be enabled for your application, you can easily enable them in the Security screen.

General

Description

In the General section of the security settings, you can enable magic files and configure inbound connections. A Magic File is a script on a USB drive that executes once it is inserted into the system. This function is disabled by default to make sure that magic files are not unknowingly executed on PolyScope.

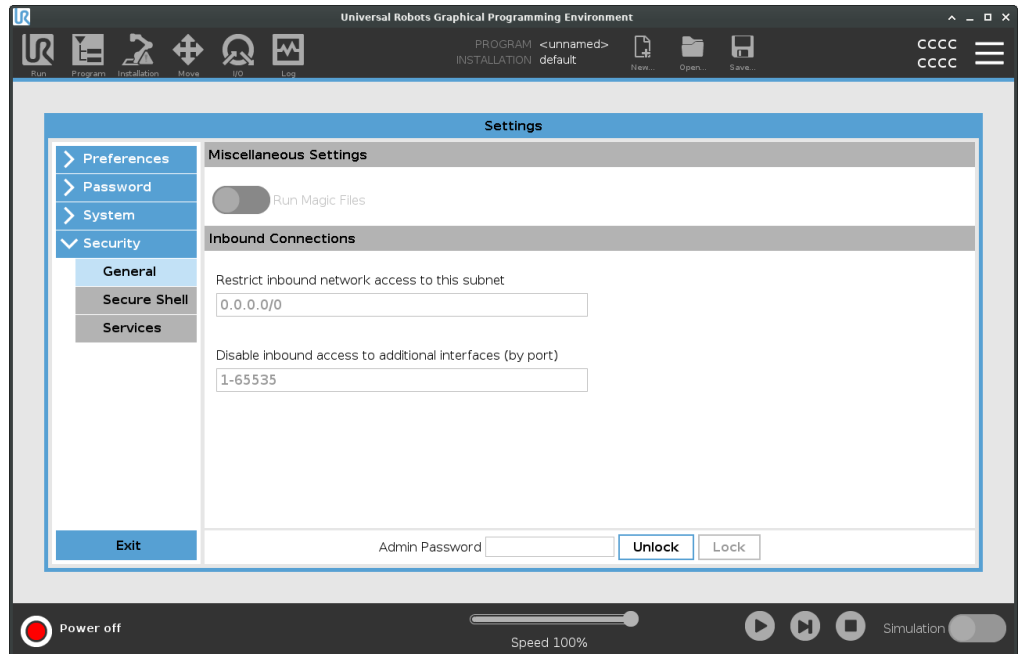

Magic Files

Magic files have unrestricted privileges to make system changes, thus they must be considered as a security liability.

To enable Magic Files on PolyScope

1. In the Header, tap the Hamburger menu and select **Settings**.
2. Under Security, select **General**.
3. Enter your Admin password.
4. Enable **Run Magic Files**.

Restrict Inbound Connections

The network access has been set to 0.0.0.0/0 has a security setting to ensure that there is no access to the subnet in PolyScope.

WARNING

URCaps may require particular network interfaces to be open in order to function.

- Consult your URCaps vendor/s, if any of your URCaps require particular network interfaces (ports/services) to be open.

Configuring Inbound Connections

Use **Restrict inbound network access to a specific subnet** to make sure network connections originating from an IP-address outside the indicated subnet will be refused. For example:

- Use 192.168.1.0/24 to only allow access from hosts in the range of 192.168.1.0 - 192.168.1.255.
- Use 192.168.1.96 to allow inbound access only from this host.

1. In the Header, tap the Hamburger menu and select **Settings**.
2. Under Security, select **General**.
3. Enter your Admin password.
4. Enter subnet restrictions under **Restrict inbound network access to a specific subnet**.

Disable Inbound Access

Use **Disable inbound access to additional interfaces (by port)** to make sure any inbound connection to the designated ports will be refused.

1. In the Header, tap the Hamburger menu and select **Settings**.
2. Under Security, select **General**.
3. Enter your Admin password.
4. Enter the interfaces to be closed in **Disable inbound access to additional interfaces (by port)**.

Leave the field blank to avoid blocking ports. Any enabled service [Services on page 347](#) will take precedence over port blocking. Even if a port is blocked in the general security settings, it will be open by an enabled service.

Example

- You can block all ports
 - Use 1-65535 to block all ports.
- You can block one specific port
 - You can use port number 564 to block port 564.
- You can block a range of ports
 - Use ranges to block a specific range of ports. 2318-3412, 22, 56-67 to block specific ports and specific ranges of ports.

Secure Shell

Description

Secure Shell (SSH) provides a private (encrypted) and authenticated connection to the robot allowing:

- operating system access
- file copying
- tunneling of network interfaces



NOTICE

SSH is a powerful tool if used as intended. Make sure you understand how to use SSH technology securely before you enable it on your robot.

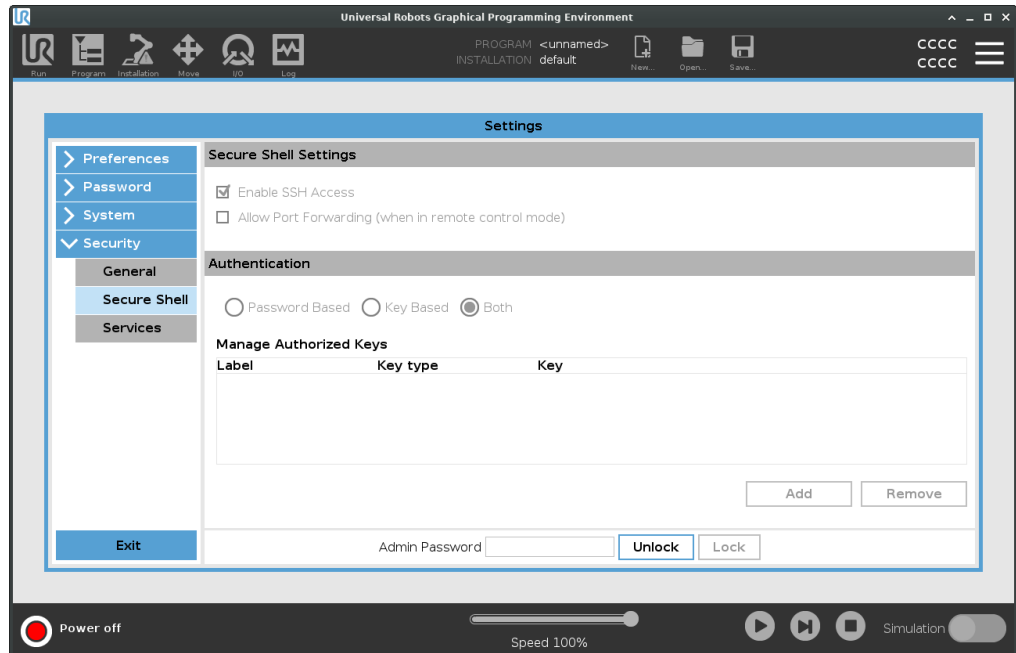

To enable SSH Access

1. In the Header, tap the Hamburger menu and select **Settings**.
2. Under Security, select **Secure Shell**.
3. Enter your Admin password.
4. Configure the Secure Shell Settings:
 - Select **Enable SSH Access**.
 - Select to enable/disable **Allow Port Forwarding (when in remote control mode)**.
 Port forwarding is only available in remote control mode.
 Port forwarding is a recommended technique for wrapping open interfaces (eg. the Dashboard service) in a secure and encrypted tunnel requiring authentication.
5. Select the Authentication type.

Authentication

Any SSH connection requires the connecting user to authenticate when the connection is established. You can set up authentication with a password and/or with a pre-shared, authorized key.

Key based authentication relies on pre-shared keys.

To use Authentication

Available keys are listed here together with buttons for removing a selected key from the list and for adding new keys.

1. Tap **Add** to open a file selection dialog.
2. Select a key from the file.

The file is read line by line adding only lines which are not blank and not identified as comments (starting with #). No validation of lines added is done.

3. They must comply with the format used for `authorized_keys`.

Services

Description

Services lists the standard services running on the robot. You can enable or disable each service.

NOTICE

All services are disabled as a security feature. When you start or configure your robot, you have to enable relevant services.

An enabled service remains available even if the ports associated with that service are blocked. So, simply blocking a port is not enough to prevent access to the listed services if they are enabled.

Enabling Services

To enable Services

You have to enable the relevant service for the function that you are using.

1. In the Header, tap the Hamburger menu and select **Settings**.
2. Under Security, select **Services**.
3. Enter your Admin password.
4. In the list, select an option and tap **Enable**, or tap **Disable**.

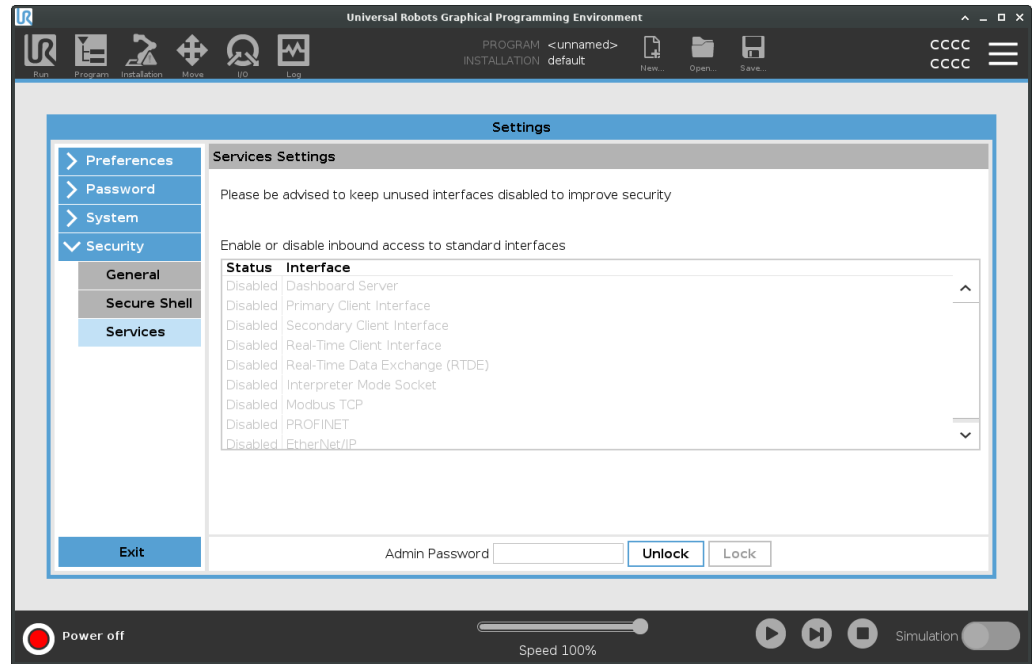

25.3. Shutdown Robot

Description	The Shutdown Robot button allows the robot to be powered off or restarted.
--------------------	---

To shut down the robot	<ol style="list-style-type: none">1. In the Header, tap the Hamburger menu and select Shutdown Robot.2. When the Shutdown Robot dialog box appears, tap Power Off.
-------------------------------	---

26. Glossary

Stop Category 0

Robot motion is stopped by immediate removal of power to the robot. It is an uncontrolled stop, where the robot can deviate from the programmed path as each joint brake as fast as possible. This robot stop is used if a safety-related limit is exceeded or in case of a fault in the safety-related parts of the control system. For more information, **see ISO 13850 or IEC 60204-1**.

Stop Category 1

Robot motion is stopped with power available to the robot to achieve the stop and then removal of power when the stop is achieved. It is a controlled stop, where the robot will continue along the programmed path. Power is removed as soon as the robot stands still. For more information, **see ISO 13850 or IEC 60204-1**.

Stop Category 2

A controlled stop with power left available to the robot. The safety-related control system monitors that the robot stays at the stop position. For more information, **see IEC 60204-1**.

Category 3

The term *Category* should not be confused with the term *Stop Category*. *Category* refers to the type of architecture used as basis for a certain *Performance Level*. A significant property of a *Category 3* architecture is that a single fault cannot lead to loss of the safety function. For more information, **see ISO 13849-1**.

Performance Level

A Performance Level (PL) is a discrete level used to specify the ability of safety-related parts of control systems to perform a safety functions under foreseeable conditions. PLd is the second highest reliability classification, meaning that the safety function is extremely reliable. For more information, **see ISO 13849-1**.

Diagnostic coverage (DC)

is a measure of the effectiveness of the diagnostics implemented to achieve the rated performance level. For more information, **see ISO 13849-1**.

MTTFd

The Mean time to dangerous failure (MTTFd) is a value based on calculations and tests used to achieve the rated performance level. For more information, **see ISO 13849-1**.

Integrator

The integrator is the entity that designs the final robot installation. The integrator is responsible for making the final risk assessment and must ensure that the final installation complies with local laws and regulations.

Risk assessment

A risk assessment is the overall process of identifying all risks and reducing them to an appropriate level. A risk assessment should be documented. Consult **ISO 12100** for further information.

Collaborative robot application

The term *collaborative* refers to collaboration between operator and robot in a robot application. See precise definitions and descriptions in ISO 10218-1 and ISO 10218-2.

Safety configuration

Safety-related functions and interfaces are configurable through safety configuration parameters. These are defined through the software interface, see part [Part II Software Manual](#).

26.1. Index

A

About 331
Align 315
Auto 315
Automatic mode 130
Automatic Mode Safeguard Reset 146
Automatic Mode Safeguard Stop 146

B

Base 79, 111, 194
Base feature 295
Blend parameters 208
Blending 206, 208, 210-211
Bracket 58

C

Command 178
comment 231
Cone angle 158
Cone center 158
Configurable I/O 47
Control 167
control box 112, 320
Control Box 13, 39, 44, 46, 56, 59-60, 91, 284
Conveyor Tracking 46, 260
Conveyor Tracking Setup 291
Custom 141

D

Delete 150
direction 218
Direction Vector 220
Disabled 150, 152
Disabled Tool direction limit 158

E

Edit Position 160
Elbow 79, 111
Elbow Force 142
Elbow Speed 142
Error 264
Ethernet 58, 304
EtherNet/IP 58, 282, 308
Expression Editor 241

F

Factory Presets 141
Feature 292, 295, 315
Feature menu 251
File Path 326
Folder 232
Footer 116, 168, 186
Frame 252
Freedrive 36-37, 130, 253, 280, 296, 315-316

G

General purpose I/O 47
Graphics 181

H

halt 230

Hamburger Menu 118

Header 116

Home 315

I

I/O 44, 47, 117, 145, 282, 320

Initialize 113, 118

input signals 145

Installation 117, 326, 328

Installation variables 284

J

Joint Limits 142

joint space 192

L

Log 117, 323

M

Manual High Speed 118, 132

Manual mode 130

Mini Displayport 58

MODBUS 58, 291, 304, 306, 322

mode

Automatic 117, 131

Local 118

Manual 117, 131

Remote 118

Modes 150

Momentum 141

Motion 252

Mounting bracket 13

Move 117, 130, 178, 191, 195, 319

Move robot to 169

Move Tool 314

MoveJ 297, 319

MoveL 297, 319

MoveP 297

N

New... 117, 326

Normal 35, 150

Normal & Reduced 150

Normal & Reduced Tool direction limit 158

Normal mode 140, 158, 182, 318

Normal Plane 152

Normal Tool direction limit 158

Not Reduced mode 147

O

Open... 117, 326

output signals 147

P

Pan angle 158

Play 118, 168, 186

Point 252

PolyScope 12, 36-37, 111-112, 116, 126, 139, 235, 274, 304, 308, 341

popup 228

Pose Editor 315, 318

Position 160
Position range 142
Power 141
Profinet 308
Profisafe 309
Program 117, 165, 169, 260, 326, 328
Program and Installation Manager 117, 326
program node 171
Program Tree 171

R

Radius 160
Recovery 36-37
Recovery mode 140
Reduced 35, 150
Reduced mode 140, 145, 147, 158, 160
Reduced Tool direction limit 158
relative waypoint 203
Relative waypoint 194
Remote Control 287, 341
Rename 150
Restrict Elbow 153
risk assessment 13, 17, 26, 30
Robot 159, 314
robot arm 44, 111, 113, 247-248, 252, 284, 314
Robot arm 91
robot cable 61-62
Robot Limits 140
Robot Moving 147
Robot Not Stopping 147
Run 117, 165

S

safe Home 147

Safeguard Reset 146
Safety Checksum 118, 137
Safety Configuration 23, 133, 136-137, 140
Safety functions 28, 30
Safety I/O 28, 34, 47-48
Safety instructions 71
Safety planes 149, 314, 318
Safety Settings 17, 134, 336
Save... 117, 326, 329
Screen 116
Script manual 13
Service manual 13
set payload 233
Settings 334
Setup 316
Shoulder 79, 111
Show 150
Shut Down 349
Simple 252
Simulation 118
Speed Slider 118, 130
Step 118
Stop 118
stopped state 113
Stopping Distance 141
Stopping Time 141
Success 264
Switch Case construction 241
System Emergency stop 145
System Emergency Stop 147

T

Teach Pendant 13, 39, 56, 91, 112, 116, 139, 253, 341
Templates 260
Test button 253
Tilt angle 158

Tool 159
Tool Center Point 140, 194, 274, 315
Tool Center Position 160
Tool Direction 157-158
Tool feature 295
Tool Flange 111
Tool Force 142
Tool I/O 63
Tool Position 159-160
Tool Speed 142
Trigger Plane 152
Trigger Reduced Mode 150
Trigger Reduced Plane 35

U

Until 218
Until Distance 214
Until Expression 213
Until IO 216
Until Tool Contact 213, 215
UR Forums 14
UR+ 13
UR+ Partner Program 13
URCaps 340

V

Variable feature 194
variable waypoint 205
Variable waypoint 194
Variables 165, 169, 183
Voltage 320

W

Wait 220

Waypoint 178, 191, 194-195, 206, 208, 210-211

Waypoints 127

Wrist 111

Software Name: PolyScope
Software Version: 5.16
Document Version: 10.4.186

